



CITY OF EL PASO

# STORMWATER DESIGN MANUAL

CONTENTS

---

SECTION 1. INTRODUCTION ..... 1

SECTION 2. DESIGN CRITERIA..... 2

SECTION 3. HYDROLOGY ..... 5

    3.1 Methodology Selection..... 5

    3.2 Time of Concentration..... 8

        3.2.1 Time of Concentration in minutes..... 8

    3.3 Runoff Coefficient ..... 11

    3.4 Unit Hydrograph ..... 13

        3.4.1 Runoff Curve Number ..... 13

        3.4.2 Travel Time..... 21

        3.4.3 Lag Time..... 23

        3.4.4 Rainfall Distribution..... 23

SECTION 4. PAVEMENT DRAINAGE ..... 24

SECTION 5. STORM SEWER PIPE ..... 24

    5.1 Velocities ..... 24

        5.1.1 Minimum ..... 24

        5.1.2 Maximum..... 24

SECTION 6. OPEN CHANNEL ..... 25

    6.1 Velocities ..... 25

        6.1.1 Minimum Velocity ..... 25

        6.1.2 Maximum Velocity..... 25

    6.2 Channel Access for Maintenance..... 25

SECTION 7. CULVERTS..... 26

SECTION 8. BRIDGES ..... 27

    8.1 Scour..... 27

    8.2 Freeboard..... 27

    8.3 Supercritical Flow ..... 27

    8.4 Additional Design Considerations ..... 28

    8.5 Minimum Clear Height ..... 28

SECTION 9. STORMWATER BASIN ..... 28

    9.1 General ..... 28

9.2	Definitions .....	28
9.3	Objectives .....	29
9.4	Guidelines for Storm Water Ponding.....	29
9.4.1	Pond Geotechnical Engineering Evaluation .....	29
9.4.2	Storage Capacity .....	30
9.5	Basin Geometric Controls .....	30
9.5.1	Shape .....	30
9.5.2	Side Slopes.....	31
9.5.3	Depth and Bottom Configuration.....	36
9.6	Drain Time.....	36
9.7	Lining/Surface Treatment.....	36
9.8	Subsurface Disposal .....	37
9.9	Drywell.....	37
9.10	Spillways .....	37
9.11	Primary .....	37
9.12	Emergency .....	37
9.13	Maintenance Considerations.....	38
<b>SECTION 10. OTHER HYDRAULIC ELEMENTS .....</b>		<b>38</b>
10.1	Channel Drop Structure.....	38
10.2	Application of Drop Structures.....	39
10.3	Energy Dissipation Structures .....	39
10.4	Debris Barriers.....	39
10.5	Sediment Basins.....	39
<b>SECTION 11. SEDIMENT TRANSPORT.....</b>		<b>40</b>
11.1	Purpose and Need.....	40
11.1.1	Sediment and Debris Mechanisms.....	40
11.1.2	Sediment and Debris Hazards.....	40
11.1.3	Purpose.....	41
11.2	Design Criteria Sources and Types:.....	41
11.3	Sediment Basin Design Criteria.....	41
11.4	Channel Design Criteria .....	43
11.5	Culvert Design Criteria .....	43
11.6	Storm Drain System Design Criteria.....	43

SECTION 12. FLOODPLAIN MANAGEMENT..... 43

- 12.1 FEMA Defined Floodplains and Floodways..... 44
- 12.2 Best Available Data..... 44
- 12.3 CLOMR Requirement Prior to Issuance of a Grading Permit..... 44
- 12.4 LOMR Requirement Prior to Final Development Approval..... 44
- 12.5 Location of Structures ..... 44
- 12.6 Public and Private Roads Affecting Effective SHFA’s ..... 45
- 12.7 Floodplain Management Standards for SFHA’s without BFE’s ..... 45
- 12.8 Anchoring ..... 45
- 12.9 Construction Materials and Methods ..... 46
- 12.10 Utilities ..... 46
- 12.11 Subdivision Proposals in SFHA’s ..... 46
- 12.12 Standards of Areas of Shallow Flooding (AO and AH Zones)..... 46
- 12.13 Floodplain Management Standards for SFHA’s w/ Established BFE’s..... 47
- 12.14 Residential Construction..... 47
- 12.15 Nonresidential Construction..... 47
- 12.16 Manufactured Homes..... 47
- 12.17 Floodways or Arroyo..... 48
- 12.18 Areas Outside the SFHAs ..... 48
- 12.19 Requirement to Delineate 100-year Special Flood Hazard Area or Establish  
Minimum Finished Floor Elevation ..... 48
- 12.20 Erosion Protection ..... 48
- 12.21 Lot Grading ..... 49

SECTION 13. RIGHTS-OF-WAY AND EASEMENTS ..... 49

- 13.1 Storm Water Design..... 49
  - 13.1.1 General Requirements ..... 49
  - 13.1.2 Accessibility to public storm sewers ..... 49
  - 13.1.3 Accommodation of downstream drainage areas ..... 49
  - 13.1.4 Accommodation of Runoff ..... 50

SECTION 14. GREEN INFRASTRUCTURE..... 50

- 14.1 Background and Purpose..... 50
  - 14.1.1 Philosophy and Definitions..... 51
  - 14.1.2 Green Infrastructure Practices Recommended for El Paso..... 52
- 14.2 Green Infrastructure within the Public Right of Way ..... 52
  - 14.2.1 Bioretention Basins..... 52
  - 14.2.2 Locating Bioretention Basins within Street Right of Ways..... 53



14.2.3	Distribution and Sizing of Bioretention Basins.....	53
14.2.4	Bioretention Basin Design .....	54
14.2.5	Curb Cuts, Inlets, and Sediment Traps .....	57
14.2.6	Below Grade Storage Systems .....	58
14.2.7	Design Considerations for Steep Streets.....	59
14.2.8	Landscaping .....	60
14.2.9	Related Design Guides and References .....	61
14.2.10	Additional Green Infrastructure Approaches .....	61
14.3	Park Ponds .....	62
14.3.1	Background .....	62
14.3.2	Concept Design Criteria.....	62
SECTION 15. BIBLIOGRAPHY .....		64

## LIST OF TABLES

---

Table 2- 1: Hydrologic Design Criteria.....	3
Table 3- 1: Option 1: Atlas 14 Depth-Duration-Frequency Curves .....	7
Table 3- 2: Curvilinear interpolation of Short Duration intensity, based on Atlas 14 values 7	
Table 3- 3: Time of Concentration.....	8
Table 3- 4: Rational Method Coefficient (C) .....	12
Table 3- 5: Hydrologic Soil Groups.....	14
Table 3- 6: Runoff Curve Numbers for Arid and Semi-Arid Rangelands <sup>1</sup> .....	15
Table 3- 7: Runoff Curve Numbers for Urban Areas <sup>1</sup> .....	16
Table 3- 8: Runoff Curve Numbers for Cultivated Agricultural Land <sup>1</sup> .....	17
Table 3- 9: Runoff Curve Numbers for Other Agriculture Land.....	18
Table 3- 10: Example Curve Number Chart.....	19
Table 3- 11: Roughness coefficients for sheet flow from TR-55 .....	22
Table 11- 1: Clogging Factors .....	43

## LIST OF FIGURES

---

Figure 3- 1: Urban Conditions.....	6
Figure 3- 2: Average Velocity .....	10
Figure 3- 3: Example subbasin land cover .....	19
Figure 3- 4: Jurisdictional Dam Requirements from TCEQ .....	21
Figure 3- 5: Example Subbasin with Tc flow path designations .....	21
Figure 11- 1: Example Sediment Basin Layout.....	42

## LIST OF EQUATIONS

---

Equation 3- 1: The Rational Method.....	6
Equation 3- 2: Runoff Volume .....	6
Equation 3- 3: Time of Concentration – Kirpich Formula.....	8
Equation 3- 4: Time of Concentration – Upland Method .....	9
Equation 3- 5: Mannings Equation Average Velocity .....	11
Equation 3- 6: Weighted Runoff Coefficient .....	12

Equation 3- 7: Runoff Curve Numbers for Dry Soils ..... 20

Equation 3- 8: Runoff Curve Numbers for Wet Soils..... 20

Equation 3- 9: Time of Concentration – Velocity Method ..... 22

Equation 3- 10: Travel Time for sheet flow ..... 22

Equation 3- 11: Travel Time for Shallow and Open Channel Flow ..... 23

Equation 3- 12: Mannings Equation Average Velocity ..... 23

Equation 3- 13: Lag Time..... 23

Figure 11- 1: Example Sediment Basin Layout..... 42

DRAFT

## LIST OF ACRONYMS

---

AC:	Acre
AEP:	Annual Exceedance Probability
AMAFCA:	Albuquerque Metropolitan Arroyo Flood Control Authority
ASCE:	American Society of Civil Engineers
ASTM:	American Society for Testing and Materials
BFE:	Base Flood Elevation
CFS:	Cubic Feet per Second
CLOMR:	Conditional Letter of Map Revision
CMU:	Concrete Masonry Unit
CN:	Curve Number
CoEP	City of El Paso
DDM:	Drainage Design Manual
DFIRMS:	Digital Federal Insurance Rate Map
DTM:	Digital Terrain Model
EPA:	Environmental Protection Agency
EPWU:	El Paso Water Utilities
FDP:	Flood Damage Prevention
FEMA:	Federal Emergency Management Agency
FHBM:	Flood Hazard Boundary Map
FHWA:	Federal Highway Administration
FIRM:	Federal Insurance Rate Map
FPS:	Feet Per Second
GI:	Green Infrastructure
HDS:	Hydraulic Design Series
HEC-HMS:	Hydrologic Engineering Center Hydrologic Modeling Software
HEC-RAS:	Hydrologic Engineering Center River Analysis System
HW:	Headwater
HMAC:	Hot Mix Asphalt Concrete
LID:	Low Impact Development

LOMA:	Letter of Map Amendment
LOMR:	Letter of Map Revision
NFIP:	National Flood Insurance Program
NRCS:	National Resource Conservation Service
NRDC:	Natural Resource Defense Council
P.I:	Plasticity Index
RCP:	Reinforced Concrete Pipe
ROW:	Right-of-Way
SEA:	Street Edge Alternative
SCS:	Soil Conservation Service now
SFHA:	Special Flood Hazard Areas
SSWM:	Sustainable Stormwater Management
TC:	Time of Concentration
TCEQ:	Texas Commission on Environmental Quality
TXDOT:	Texas Department of Transportation
USBR:	Bureau of Reclamation
USDA:	US Department of Agriculture
USDHS:	US Department of Homeland Security
USGS:	United States Geological Survey
USDOI:	US Department of the Interior
WSEL:	Water Surface Elevation

**SECTION 1. INTRODUCTION**

---

This Stormwater Design Manual (SWDM) is an official document authorized by the City of El Paso who adopt this regulation. Under the authority of the City Engineer, they may revise and/or approve design plans and construction related to the SWDM provisions in their respective areas described in these regulations. Both entities are committed to successfully implementing and achieving the goals of this SWDM for the benefit of the citizens of El Paso relative to Storm Water Management.

Adopted on \_\_\_\_\_, 2022.

Approved By: \_\_\_\_\_

DRAFT

## **SECTION 2. DESIGN CRITERIA**

---

It is the policy of the City of El Paso and its municipalities, to design drainage structures to meet certain minimum standards. In general, drainage structures are designed to safely pass a flood flow, the magnitude of which is commensurate with a level of public safety and economic risk. This document establishes minimum standards in terms of design frequency floods and their effect on a drainage facility. Design frequency floods shall be estimated using the procedures described in subsequent chapters of this SWDM.

Drainage structures must also be designed to meet all applicable laws including those concerning:

- Alterations of floodplains established in flood insurance studies.
- Construction in flood hazard areas.
- Encroachments or effects on the waters of the United States.
- Water pollution control, including sediment control.
- Protection of fish and wildlife.
- Protection of neighboring property owners.
- Prevention of adverse social and economic impacts.
- Protection of historic properties and archaeological sites.

Designers shall use the flood magnitudes, as presented in Table 2- 1, unless otherwise directed in writing by the City Engineer. Maximum water surface limits shown in this table shall be observed. Hydrologic and Hydraulic analysis of drainage structures shall be performed using the methods identified in the subsequent chapters of this SWDM. Engineer of Record or a Professional Engineer shall verify that improvements are constructed in accordance to approved development plans.

**Table 2- 1: Hydrologic Design Criteria**

Conveyance Structures	Design Storm and Duration	Maximum Water Surface
Streets (Arterial and Major Collector)	50-year	One lane high and dry (on roadways of four lanes or more)
	100-year	Within curb height (maximum curb h=1½” below top of curb and 50 cfs max)
Streets (Local Streets)	50-year	One lane high and dry
	100-year	Within curb height (maximum curb h= 1½” below top of curb and 50 cfs max)
Storm Drain System	100-year	Limit HGL 1 ft. below finished grade
Channels	100-year	Contains Water Surface Elevation (WSEL) plus 1 ft of freeboard required
Culverts	100-year	Limit headwater (HW) to top of Headwall. Ratio of headwater depth to culvert rise shall not exceed 1.5. 20 % Clogging factor shall be used
Bridges	100-year	WSEL plus 2-foot freeboard below the low chord
	500-year	Withstand the structural forces
Retention Basins (no outlet)	100-year-24	Contain 100% of the runoff volume with 1 foot of freeboard and sedimentation calculations. Apply a sediment bulking factor of 18% for open space and 6% for urbanized areas with paved roads and curb and gutter. A 30% safety factor shall be added to computed inflow volume to account for back-to-back storms
Detention Basins	100-year-24	Basins to be designed utilizing good engineering practices and accepted methods (HEC-HMS) whereby 100% of the runoff volume to be properly managed using channels and basins. Detention basin shall have 1-foot free board from peak storage elevation to spillway weir. Apply a sediment bulking factor of 18% for open space and 6% for urbanized areas with paved roads and curb and gutter.

*Note:*

1. For Arterial and Major Collector streets, if street has no median one lane is equal to 4 feet on either side of the crown of the road, 8 feet total. For street with a median, one lane 8 feet wide on both sides of the median.
2. For local streets one lane is equal to 4 feet on either side of the crown of the road, 8 feet total.
3. All inlets shall include 50% factor for clogging.
4. Maximum allowed runoff velocity on surface of HMA streets is six (6) feet per second
5. Place inlets prior to horizontal curves in roadways
6. Bypass shall not exceed one (1) cfs



General Design Notes:

1. Developers are responsible for the developed runoff generated by proposed development. If the watershed has no positive outfall, the historic and developed flows shall be retained within the property.
2. A positive outfall is defined as existing flows conveyed to a watershed outlet without negative impact.
3. Historic runoff is defined as when the land was initially undeveloped.
4. The duration for all design frequency floods is 24-hours and 3 hours for conveyance.
5. Drainage structures must be sized so that the 100-year floodplain is not made worse on adjacent properties.
6. Structure sizes shall account for sediment bulking of the flow within the design.
7. In no case shall a culvert size be less than 24” circular pipe culvert or its equivalent hydraulic capacity.
8. In no case shall storm drainpipe size be less than 24” circular pipe for main lines and 18” for laterals.
9. All storm water storage shall drain within 72 hours through infiltration, gravity outlet, or mechanical means. If infiltration is used, a geotechnical report, performed and sealed by a licensed geotechnical engineer, must be presented indicating these conditions can be met.
10. For projects location within 1 mile of an irrigation or drainage canal, a percolation test should be performed during irrigation season and non-irrigation season. A minimum 3 months apart per basin.
11. Design of all storm drainage pipes shall show plan and profile views, as well as all structures used to convey water (longer than 10 feet), which includes but is not limited to; swales, trench drains, alleys, roadways, flow channels, etc...
12. Discharge into basins shall utilize storm drainpipes. Flumes are prohibited to discharge directly into retention/detention basins.
13. Flumes entering a roadway must come in at a 45-degree angle in the direction of positive flow. Flow shall have a maximum velocity of six (6) feet per second with a maximum discharge of two (2) cubic feet per second.
14. Onsite ponding is allowed for new private residential subdivisions with a minimum of ½ acre per lot.
15. The minimum cover for drainage pipes shall be 3-feet from finish grade. **Pipes with less cover shall require a concrete cap or be Class IV or V RCP. See Stormwater Construction details.**

16. Basin boring tests are to be measured 15 feet below the invert of proposed basin. Infiltration is based on the PI which shall not exceed more than 8.
17. Basin ramps are to be at 12% maximum for all basins.
18. The lowest elevation of a basin cannot be less than 2 feet above the highest elevation of the ground water table.
19. The finished surface of a basin access ramp maintenance road are to be constructed with minimum 6” compacted base material as per ASTM D1557 at 95%.
20. The finish surface of the maintenance road at the perimeter of a basin shall have a finish course of 6” compacted base material compacted at 95% ASTM D1557.

### **SECTION 3. HYDROLOGY**

---

Hydrology is the process of quantifying storm water runoff discharge and volume for a specified drainage basin at a chosen concentration point. Hydrology is a means to define flood-prone areas, historical conditions, and post-developed conditions. Concentration points are located at outfall locations (lowest point of the basin) within storm drain systems, culverts, and detention ponds. Runoff is collected in waterways and conveyed to concentration points via arroyos, streams, pipe systems, channels, and streets with curbs and gutters.

Natural drainage basins are defined by existing ridgelines and can be delineated from published topographic maps, such as United States Geological Survey (USGS) topographic maps, topographic surveys, or available Digital Terrain Models (DTMs). For developed lands, drainage basins are defined by high and low point grade breaks and are depicted by on site specific topographic surveys.

#### **3.1 METHODOLOGY SELECTION**

The hydrology methodology used is chosen in accordance with Figure 3-1 and is based on the drainage area and characteristics of the watershed.

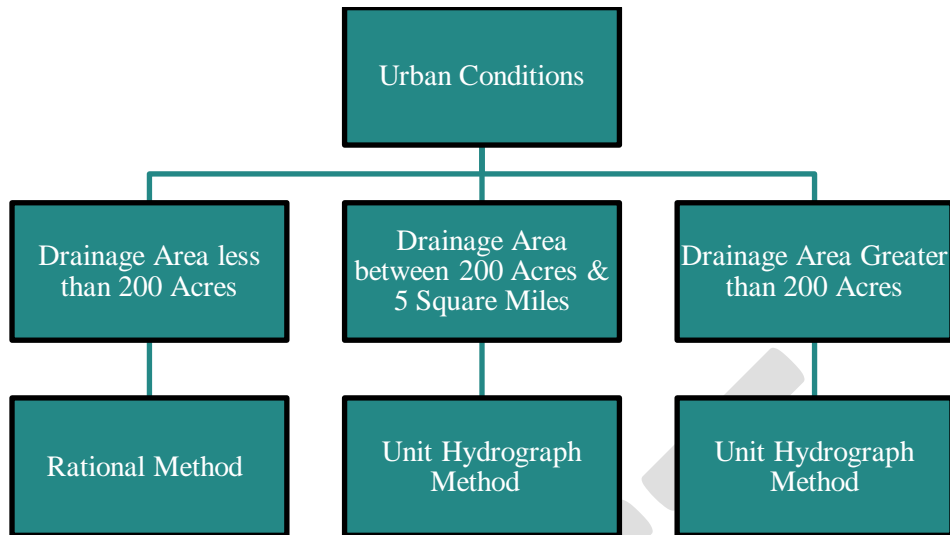

**Figure 3- 1: Urban Conditions**

*The Rational Method formula:*

**Equation 3- 1: The Rational Method**

$$Q = C \cdot I \cdot A$$

Q = Flow (cfs)

C = Runoff Coefficient (unitless)

I = Rainfall Intensity (based on Time of Concentration)

A = Drainage Area (acres)

Runoff Volume is calculated using:

**Equation 3- 2: Runoff Volume**

$$V = (A \cdot R \cdot C) / 12$$

V = Runoff Volume (acre-feet)

A = Drainage Area (acres)

R = Rainfall Depth (inches)

C = Runoff Coefficient (unitless)

Note that any pond sizing using the Rational Method will still require reservoir routing results to demonstrate adequate volume capacity, non-jurisdictional status, and freeboard criteria.

**Table 3- 1: Option 1: Atlas 14 Depth-Duration-Frequency Curves**

Return Frequency (years)	Total Rainfall Depth (inches) by Duration									
	5-min	10-min	15-min	30-min	60-min	2-hr	3-hr	6-hr	12-hr	24-hr
1	0.237	0.394	0.455	0.568	0.682	0.791	0.855	0.965	1.07	1.18
2	0.308	0.513	0.592	0.739	0.887	1.02	1.11	1.25	1.38	1.54
5	0.417	0.695	0.803	1.00	1.20	1.39	1.49	1.68	1.86	2.07
10	0.514	0.856	0.989	1.24	1.48	1.70	1.83	2.06	2.29	2.56
25	0.653	1.09	1.26	1.57	1.88	2.16	2.32	2.61	2.92	3.29
50	0.766	1.28	1.48	1.84	2.21	2.53	2.71	3.06	3.44	3.90
100	0.888	1.48	1.71	2.14	2.56	2.93	3.14	3.54	4.02	4.58
200	1.02	1.69	1.97	2.46	2.95	3.37	3.62	4.09	4.67	5.36
500	1.21	1.98	2.34	2.93	3.49	4.01	4.30	4.88	5.62	6.50
1000	1.37	2.20	2.64	3.31	3.94	4.53	4.86	5.53	6.41	7.46

**Table 3- 2: Curvilinear interpolation of Short Duration intensity, based on Atlas 14 values**

Duration	Rainfall Intensity (inches/hour) by Return Period									
	1-year	2-year	5-year	10-year	25-year	50-year	100-year	200-year	500-year	1000-year
5-min	2.84	3.70	5.00	6.17	7.84	9.19	10.66	12.24	14.52	16.44
6-min	2.77	3.60	4.87	6.00	7.63	8.95	10.37	11.87	13.99	15.70
7-min	2.68	3.49	4.73	5.83	7.41	8.70	10.07	11.50	13.49	15.05
8-min	2.59	3.37	4.56	5.62	7.15	8.40	9.72	11.08	12.98	14.42
9-min	2.48	3.23	4.38	5.39	6.86	8.06	9.32	10.63	12.44	13.81
10-min	2.36	3.08	4.17	5.14	6.54	7.68	8.88	10.14	11.88	13.20
11-min	2.24	2.92	3.96	4.87	6.20	7.29	8.42	9.63	11.32	12.61
12-min	2.12	2.76	3.75	4.61	5.88	6.90	7.97	9.14	10.77	12.04
13-min	2.01	2.62	3.55	4.37	5.57	6.54	7.56	8.68	10.26	11.51
14-min	1.91	2.49	3.37	4.15	5.29	6.21	7.18	8.26	9.79	11.01
15-min	1.82	2.37	3.21	3.96	5.04	5.92	6.84	7.88	9.36	10.56
16-min	1.74	2.26	3.07	3.78	4.82	5.66	6.54	7.54	8.98	10.14
17-min	1.67	2.17	2.95	3.63	4.62	5.43	6.28	7.24	8.63	9.76
18-min	1.61	2.09	2.83	3.50	4.45	5.22	6.04	6.97	8.31	9.41
19-min	1.55	2.01	2.73	3.37	4.29	5.03	5.82	6.72	8.02	9.08
20-min	1.50	1.95	2.64	3.26	4.14	4.86	5.63	6.49	7.75	8.78
21-min	1.45	1.88	2.55	3.15	4.01	4.70	5.45	6.28	7.50	8.49
22-min	1.40	1.83	2.47	3.06	3.88	4.55	5.28	6.09	7.27	8.23
23-min	1.36	1.77	2.40	2.97	3.77	4.42	5.13	5.91	7.05	7.98
24-min	1.32	1.72	2.33	2.89	3.66	4.29	4.98	5.74	6.85	7.75
25-min	1.29	1.67	2.27	2.81	3.56	4.17	4.85	5.58	6.66	7.53
26-min	1.25	1.63	2.21	2.74	3.47	4.06	4.72	5.43	6.48	7.33
27-min	1.22	1.59	2.15	2.67	3.38	3.96	4.60	5.29	6.31	7.14
28-min	1.19	1.55	2.10	2.60	3.29	3.86	4.49	5.16	6.15	6.96
29-min	1.16	1.51	2.05	2.54	3.22	3.77	4.38	5.04	6.00	6.78
30-min	1.14	1.48	2.00	2.48	3.14	3.68	4.28	4.92	5.86	6.62

### 3.2 TIME OF CONCENTRATION

The minimum recommended Time of Concentration is 10 minutes. For calculations with a Time of Concentration over 10 minutes see Table 3-3.

#### 3.2.1 Time of Concentration in minutes

Time of Concentration is computed using several methods depending on the type of water way. Please refer to Table 3- 3. The minimum recommended Time of Concentration is 10 minutes.

**Table 3- 3: Time of Concentration**

Type of Water Way	Time of Concentration Method
Shallow Concentrated Flow: Arroyos (USGS Blue Steam)	Kirpich Formula
Unconcentrated Flow (Commonly areas upstream [approximately 500 feet] of USGS Blue Stream and sheet flow)	Upland Method utilizing Velocity Charts
Concentrated flows (Commonly channels and streets)	Upland Method utilizing Mannings Equation for Velocity Computation

##### 3.2.1.1 Kirpich Formula

The Kirpich Formula is used generally for waterways defined in USGS topographic maps as perennial, intermittent, and disappearing streams. USGS topographic maps show these streams as blue or light blue continuous lines. The formula is shown below:

**Equation 3- 3: Time of Concentration – Kirpich Formula**

$$T_c = 0.0078 \left[ \frac{L^{0.77}}{S^{0.385}} \right]$$

T<sub>c</sub>= Time for drainage to arrive at the concentration point from the uppermost reach of the basin, in minutes.

L = The longest length for drainage to arrive at the concentration point from the uppermost reach of the basin, in feet.

S = Average slope of the waterway gradient, in foot per foot.

For overland flow on concrete or asphalt surfaces, the Time of Concentration developed using the Kirpich Formula can be used if it is multiplied by a factor of 0.4. For concrete channels, multiply by a factor of 0.2. No adjustment is needed for flows over bare soil or in roadside ditches.

### **3.2.1.2 Upland Method**

The Upland Method is used for waterways of unconcentrated flows, commonly known as sheet flow. These flows are generally considered a mode of drainage prior to becoming concentrated in waterways such as an arroyo or stream. The maximum flow length is 500 feet. Common land covers for Upland Method are meadows, fallow cultivation, short grass pasture, bare ground, and paved areas. Figure 3- 2 relates the gradient slope of the waterway and type of cover to obtain velocity. The general Time of Concentration equation is as follows:

#### ***Equation 3- 4: Time of Concentration – Upland Method***

$$T_c = \frac{L}{V(60)}$$

$T_c$  = Time of drainage to arrive at the concentration point from the uppermost reach of the basin, in minutes.

$L$  = The longest length for drainage to arrive at the concentration point from the uppermost reach of the basin, in feet.

$V$  = Average velocity of the waterway gradient, in feet/second obtained from Figure 3- 2 (based on Figure 15-2, National Engineering Handbook Section 4).

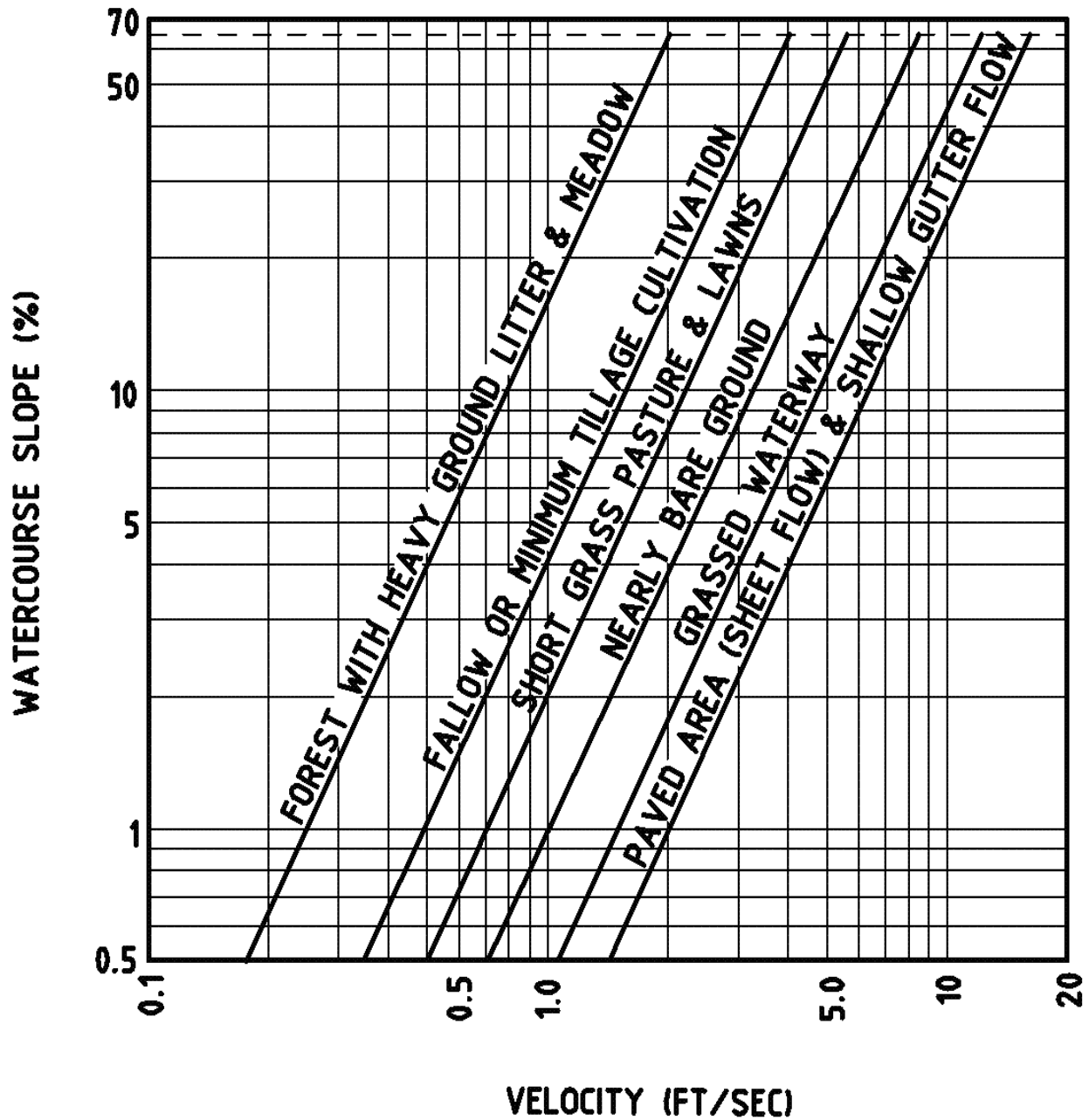

Figure 3- 2: Average Velocity

An alternate way to compute the velocity component of the Upland Method is to apply Mannings formula. This equation relates the longitudinal slope of the section, wetted perimeter, and roughness coefficient for velocity.

**Equation 3- 5: Mannings Equation Average Velocity**

$$V = \frac{1.486}{n} R^{\frac{2}{3}} S^{\frac{1}{2}}$$

V = Average velocity for section for the entire drainage waterway, in feet per second.

R = Hydraulic radius = Flow Area divided by Wetted Perimeter, in square foot per foot.

S = Average slope of the waterway gradient, in foot per foot.

Use the following procedure for estimating Time of Concentration:

1. Divide the flow path into reach lengths along which flow conditions remain reasonably consistent. Characterize the runoff along a travel path as either overland (or sheet) flow, shallow concentrated flow, or concentrated channel.
2. For each identified reach length, estimate the travel time using the method that is appropriate for the flow conditions.
3. Determine the total time by adding the individual travel times together to determine the total time.
4. Select the path that results in the longest time. The recommended minimum Time of Concentration is 10 minutes.

### **3.3 RUNOFF COEFFICIENT**

The El Paso area is unique in its mix of natural, urban, and rural landscapes, creating a vast array of surface roughness that rainfall must saturate before drainage collection begins. Below, in Table 3-4, are tabulated “C” coefficients related to the different surface land uses. The coefficient is a function of both land cover and land use.



**Table 3- 4: Rational Method Coefficient (C)**

LAND USE	Runoff Coefficient
	100-Year
Single Family Residential	0.85
Multi-Family Apartment	0.94
General Commercial	0.95
General Transportation	0.95
Pavement and Rooftops	0.95
Gravel Vehicular Travel Lanes & Shoulders	0.88
Golf Courses & Cemeteries	0.31
General Open Space (Includes mountain preserves, washes, mountain terrain, and high topographic relief)	0.50
Parks	0.50
Desert and Agriculture Flat	0.33
Landscaping with or without Impervious Under Treatment	0.95

**Note: The engineer may submit a “weighted” average coefficient on a case-by-case basis subject to the approval of the City Engineer.**

For a watershed comprising more than one characteristic, the composite C value is a weighted average dependent upon individual area segments. The composite C value is calculated by the following equation:

**Equation 3- 6: Weighted Runoff Coefficient**

$$C = \frac{\sum C_n A_n}{\sum A_n}$$

C= Weighted runoff coefficient

n= nth sub-area

Cn= Runoff coefficient for nth sub-area

An= nth sub-area size, in acres

Example: Determine the weighted C coefficient for unimproved area

Existing conditions (unimproved):

Land Use:	Area, ha (Ac):	Runoff coefficient, C:
Unimproved Grass	8.95 (22.1)	0.25
Grass	8.6 (21.2)	0.22
<hr/>		
Total	17.55 (43.3)	

Solution:

Determine Weighted C for existing (unimproved) conditions:

$$\text{Weighted C} = \frac{\sum C_n A_n}{\sum A_n} = \frac{[(22.1 \times 0.25) + (21.2 \times 0.22)]}{43.3} = 0.235$$

The precise input format for each of these elements varies with each computer program used. Guidelines for the use of a particular computer model are beyond the scope of this manual. Drainage designers wishing to use computer models for hydrologic analysis are encouraged to obtain licensed copies of the software they will be using.

### **3.4 UNIT HYDROGRAPH**

HEC-HMS shall be used for Unit Hydrograph based watershed modeling for areas greater than 200 acres. The following sections discuss critical input parameters required for modeling. A detailed tutorial for HMS model building is provided in HEC-HMS Project Tutorial, Appendix I.

#### **3.4.1 Runoff Curve Number**

Soil properties influence the relationship between rainfall and runoff by affecting the rate of infiltration. The Runoff Curve Number is a function of the hydrologic soil group and land cover condition. TXDOT general definitions for the four hydrologic soil groups are described in Table 3-5.

**Table 3- 5: Hydrologic Soil Groups**

Soil Group	Description
Group A	Group A soils have a low runoff potential due to high infiltration rates even when saturated (0.30 in/hr to 0.45 in/hr). These soils primarily consist of deep sands, deep loess, and aggregated silts.
Group B	Group B soils have a moderately low runoff potential due to moderate infiltration rates when saturated (0.15 in/hr to 0.30 in/hr). These soils primarily consist of moderately deep to deep, and moderately well to well drained soils with moderately fine to moderately coarse textures (shallow loess, sandy loam).
Group C	Group C soils have a moderately high runoff potential due to slow infiltration rates (0.05 in/hr to 0.5 in/hr). These soils primarily consist of soils in which a layer near the surface impedes the downward movement of water or, soils with moderately fine to fine texture such as clay loams, shallow sandy loams, soils low in organic content, and soils usually high in clay.
Group D	Group D soils have a high runoff potential due to very slow infiltration rates (less than 0.05 in./hr if saturated). These soils primarily consist of clays with high swelling potential, soils with permanently high water tables, soils with a clay pan or clay layer at or near the surface, and shallow soils over nearly impervious parent material such as soils that swell significantly when wet or heavy plastic clays or certain saline soils.

### 3.4.1.1 Effects of Urbanization

Consider the effects of urbanization on the natural hydrologic soil group. If heavy equipment can be expected to compact the soil during construction or, if grading will mix the surface and subsurface soils, appropriate changes should be made in the selected soil group.

The hydrologic soil group is available online for the entire El Paso area on the Natural Resources Conservation Service (NRCS) Web Soil Survey. Once the hydrologic soil group and cover type is determined, the Runoff Curve Number (CN) can be estimated using the following Table 3-6, Table 3-7, Table 3-8 and Table 3-9.

**Table 3- 6: Runoff Curve Numbers for Arid and Semi-Arid Rangelands<sup>1</sup>**

Cover Description		Curve Number for Hydrologic Soil Group			
Cover Type	Hydrologic Condition <sup>2</sup>	A <sup>3</sup>	B	C	D
Herbaceous--mixture of grass, weeds, and low-growing brush, with brush being the minor element	Poor		80	87	93
	Fair		71	81	89
	Good		62	74	85
Oak-Aspen--mountain brush mixture of oak brush, aspen, mountain mahogany, bitter brush, maple, and other brush	Poor		66	74	71
	Fair		48	57	63
	Good		30	41	48
Piñon, juniper, or both; grass understory	Poor		75	85	89
	Fair		58	73	80
	Good		41	61	71
Sagebrush with grass understory	Poor		67	80	85
	Fair		51	63	70
	Good		35	47	55
Desert shrub – major plants include salt brush, greasewood, creosote-bush, black brush, bursage, palo verde mesquite, and cactus	Poor	63	77	85	88
	Fair	55	72	81	86
	Good	49	68	79	84
Notes: <sup>1</sup> Average runoff condition, $I_a = 0.2S$ . <sup>2</sup> Poor is < 30% ground cover (litter, grass, and brush overstory) Fair is 30% to 70% ground cover Good is >70% ground cover <sup>3</sup> Curve numbers for Group A have been developed only for desert shrub.					

**Table 3- 7: Runoff Curve Numbers for Urban Areas<sup>1</sup>**

Cover Type and Hydrologic Conditions	Percent Developed	Curve Number for Hydrologic Soil Group			
		A	B	C	D
<b>Fully developed urban areas (vegetation established)</b>					
<b>Open Space: (lawns, parks, golf courses, cemeteries, etc.)<sup>3</sup></b>					
Poor condition (grass cover < 50%)		68	79	86	89
Fair condition (grass cover 50% to 75%)		49	69	79	84
Good condition (grass cover > 75%)		39	61	74	80
<b>Impervious Areas:</b>					
Paved parking lots, roofs, driveways, etc. (excluding right-of-way)		98	98	98	98
<b>Streets and Roads:</b>					
Paved: curbs and storm drains (excluding right-of-way)		98	98	98	98
Paved; open ditches (including right-of-way)		83	89	92	93
Gravel (including right-of-way)		76	85	89	91
Dirt (including right-of-way)		72	82	87	89
<b>Western Desert and Urban Areas:</b>					
Natural desert landscaping (pervious areas only) <sup>4</sup>		63	77	85	88
Artificial desert landscaping (impervious weed barrier, desert shrub with 1- to 2-inch sand or gravel mulch and basin borders)		96	96	96	96
<b>Urban Districts:</b>					
Commercial and business	85	89	92	94	95
Industrial	72	81	88	91	93
<b>Residential Districts by average lot size:</b>					
1/8 acre or less (town houses)	65	77	85	90	92
1/4 acre	38	61	75	83	87
1/3 acre	30	57	72	81	86
1/2 acre	25	54	70	80	85
1 acre	20	51	68	79	84
2 acres	12	46	65	77	82
<b>Developing urban areas:</b>					
Newly graded areas (pervious areas only, no vegetation) <sup>5</sup>		77	86	91	94

Notes:

<sup>1</sup> Average runoff condition, Ia = 0.2S.

<sup>2</sup> The average percent impervious area shown was used to develop the composite CNs. Other assumptions are as follows:

Impervious areas are directly connected to the drainage system

Impervious areas have a CN of 98,

and pervious areas are considered equivalent to open space in good hydrologic condition.

<sup>3</sup> CNs shown are equivalent to those of pasture. Composite CNs may be computed for other combinations of open space cover type.

<sup>4</sup> Composite CNs for natural desert landscaping should be computed based on the impervious area percentage (CN=98) and the pervious area CN. The pervious area CNs assumed equivalent to desert shrub in poor hydrologic condition

**Table 3- 8: Runoff Curve Numbers for Cultivated Agricultural Land<sup>1</sup>**

Cover Type	Treatment <sup>2</sup>	Hydrologic Condition <sup>3</sup>	A	B	C	D
Fallow	Bare soil		77	86	91	94
	Crop residue cover (CR)	Poor	76	85	90	93
		Good	74	83	88	90
Row Crops	Straight row (SR)	Poor	72	81	88	91
		Good	67	68	85	89
	SR+CR	Poor	71	80	87	90
		Good	64	75	82	85
	Contoured (C )	Poor	70	79	84	88
		Good	65	75	82	86
	C+CR	Poor	69	78	83	87
		Good	64	74	81	85
	Contoured & terraced (C&T)	Poor	66	74	80	82
		Good	62	71	78	81
	C&T+CR	Poor	65	73	79	81
		Good	61	70	77	80
Small grain	SR	Poor	65	76	84	88
		Good	63	75	83	87
	SR+CR	Poor	64	75	83	86
		Good	60	72	80	84
	C	Poor	63	74	82	85
		Good	61	73	81	84
	C+CR	Poor	62	73	81	84
		Good	60	72	80	93
	C&T	Poor	61	72	79	82
		Good	58	70	78	81
	C&T+CR	Poor	60	71	78	81
		Good	58	69	77	80
Close-seeded or broadcast Legumes or Rotation Meadow	SR	Poor	66	77	85	89
		Good	58	72	81	85
	C	Poor	64	75	83	85
		Good	55	69	78	83
	C&T	Poor	63	73	80	83
		Good	51	67	76	80

**Notes:**

<sup>1</sup>Average runoff condition, and Ia=0.2S.

<sup>2</sup>Crop residue cover applies only if residue is on at least 5 percent of the surface throughout the year.

<sup>3</sup>Hydrologic condition is based on a combination of factors affecting infiltration and runoff: including, (a) density and canopy of vegetative areas, (b) amount of year-round cover, (c) amount of grass or closed-seeded legume in rotations, (d) percent of residue cover on land surface (good > 20 percent), and (e) degree of roughness.

Poor: Factors impair infiltration and tend to increase runoff.

Good: Factors encourage average and better infiltration and tend to decrease runoff.

**Table 3- 9: Runoff Curve Numbers for Other Agriculture Land**

Cover Type	Hydrologic Condition	A	B	C	D
Pasture, grassland, or range-continuous forage for grazing <sup>2</sup>	Poor	68	79	86	89
	Fair	49	69	79	84
	Good	39	61	74	80
Meadow - continuous grass, protected from grazing and generally mowed for hay		30	58	71	78
Brush - brush-weeds-grass mixture, with brush the major element <sup>3</sup>	Poor	48	67	77	83
	Fair	35	56	70	77
	Good	30 <sup>4</sup>	48	65	73
Woods - grass combination (orchard or tree farm) <sup>5</sup>	Poor	57	73	82	86
	Fair	43	65	76	82
	Good	32	58	72	79
Woods <sup>6</sup>	Poor	45	66	77	83
	Fair	36	60	73	79
	Good	30 <sup>4</sup>	55	70	77
Farmsteads - Buildings, lanes, driveways and surrounding lots		59	74	82	86

<sup>1</sup>Average runoff condition

<sup>2</sup>Poor: <50% ground cover or heavily grazed with no mulch.  
 Fair: 50 to 75% ground cover and not heavily grazed.  
 Good: >75% ground cover and lightly or only occasionally grazed.

<sup>3</sup>Poor: <50% ground cover.  
 Fair: 50 to 75% ground cover.  
 Good: >75% ground cover.

<sup>4</sup>Actual curve number is less than 30; use CN = 30 for runoff computations.

<sup>5</sup>CN's shown were computed for areas with 50% woods and 50% grass (pasture) cover. Other combinations of conditions may be computed from the CN's for woods and pasture.

<sup>6</sup>Poor: Forest litter, small trees, and brush are destroyed by heavy grazing or regular burning.  
 Fair: Woods are grazed but not burned, and some forest litter covers the soil.  
 Good: Woods are protected from grazing, and litter and brush adequately cover the soil.



Table 3-6, Table 3-7, Table 3-8 and Table 3-9 include CN values for numerous urban land uses. For urban land use the CN is based on a specific percentage of imperviousness. For example, the CN values for commercial land use are based on an imperviousness of 85 percent. The NRCS web soil survey data is representative of in situ conditions and often does not account for development, grading, and compaction activities. As such, any subbasins that are in residential and commercial areas, shall be assigned CN representative of hydrologic soil group C.

**3.4.1.2 Curve Number Weighting**

Subbasins shall be delineated to be as homogenous as possible to prevent lumping of vastly different land uses. For example: The aerial image shows undeveloped upstream tributary watersheds with downstream development. The example basin outlined is incorrect due to the lumping of distinct development and watershed conditions. Lumping a subbasin in the manner shown below will cause under prediction of peak discharges.



*Figure 3- 3: Example subbasin land cover*

Note: If curve numbers in a subbasin differ by 7 or more, the subbasin shall be divided further in a more homogenous fashion to prevent lumping of curve numbers.

An appropriately delineated subbasin that has mixed land uses may use areal weighting to compute a composite curve number as shown in the example below.

*Table 3- 10: Example Curve Number Chart*

	Area (acres)	HSG	Curve Number
Sample Subbasin Total Area	200		
Area of Subbasin that’s Commercial	50	C	94
Area of Subbasin that’s 1/8 <sup>th</sup> acre residential	100	C	90
Area of Subbasin that’s 1/2 Acre residential	50	C	80



Example:

$$\begin{aligned} \text{Composite Curve Number} &= (\text{Area 1 X CN 1} + \text{Area 2 X CN 2} + \text{Area 3 X CN 3}) / \text{Total Area} \\ &= (50*94) + (100*90) + (50*80) / 200 = 89 \end{aligned}$$

### **3.4.1.3 Antecedent Moisture Condition**

Rainfall infiltration losses depend primarily on soil characteristics and land use (surface cover). The NRCS method uses a combination of soil conditions and land use to assign runoff factors known as runoff Curve Numbers (CN). These represent the runoff potential of an area when the soil is not frozen. The higher the CN, the higher the runoff potential. The following tables provide an extensive list of suggested runoff curve numbers. The CN values assume medium antecedent moisture conditions (CN II). If necessary, adjust the Runoff CN for wet or dry antecedent moisture conditions. Use a five-day period as the minimum for estimating antecedent moisture conditions. Antecedent soil moisture conditions also vary during a storm; heavy rain falling on a dry soil can change the soil moisture condition from dry to average to wet during the storm period. Equation 3- 7 adjusts values for expected dry soil conditions (CN I). Use Equation 3- 8 accommodate wet soils (CN III). For help determining which moisture condition applies, see the table titled Rainfall Groups for Antecedent Soil Moisture Conditions during Growing and Dormant Seasons.

#### ***Equation 3- 7: Runoff Curve Numbers for Dry Soils***

$$\text{CN(I)} = \frac{4.2 \text{ CN (II)}}{10 - 0.058 \text{ CN(II)}}$$

#### ***Equation 3- 8: Runoff Curve Numbers for Wet Soils***

$$\text{CN(III)} = \frac{23 \text{ CN (II)}}{10 - 0.13 \text{ CN(II)}}$$

The curve numbers presented in Tables 3-6 to 3-9 are all based on AMC II conditions which shall be the default curve numbers. AMC III curve numbers shall be used when designing a dam that falls under the TCEQ jurisdiction as defined in Chapter 1, Section 1.6 in the Design and Construction Guidelines for Dams in Texas. A brief description of the criteria is presented in Figure 3- 4.

### 1.6 Definitions

Many of the words and terms used throughout these guidelines are defined in the glossary, “Dam Safety Terms.” According to 30 TAC 299.1(a), dams fall under the jurisdiction of the TCEQ Dam Safety Program if they meet one or more of the following four criteria:

- (1) [they] have a height greater than or equal to 25 feet and a maximum storage capacity greater than or equal to 15 acre-feet;
- (2) [they] have a height greater than 6 feet and a maximum storage capacity greater than or equal to 50 acre-feet;
- (3) [they] are a high- or significant-hazard dam as defined in §299.14 (relating to Hazard Classification Criteria), regardless of height or maximum storage capacity; or
- (4) [they] are used as a pumped storage or terminal storage facility.

### 1.7 Acknowledgements

These guidelines are based substantially on the work of many agencies and individuals that have contributed greatly to the design and construction of dams in the United States. These agencies and individuals are credited in the Bibliography, at the end of these guidelines.

Figure 1.1. Definition of a Jurisdictional Dam

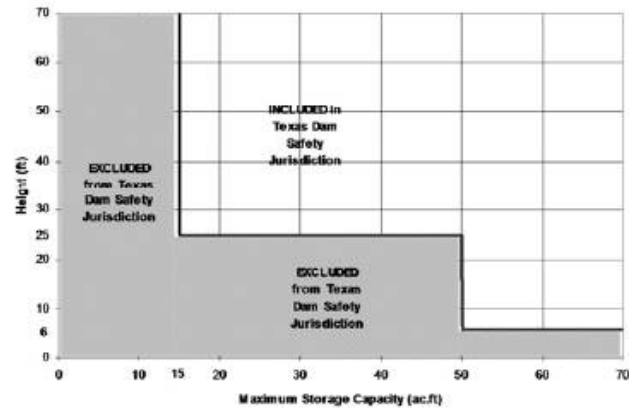

Figure 3- 4: Jurisdictional Dam Requirements from TCEQ

### 3.4.2 Travel Time

Travel time (Tt) is the time it takes water to travel from one location to another in a watershed. Tt is a component of time of concentration (Tc), which is the time for runoff to travel from the hydraulically most distant point of the watershed to a point of interest within the watershed. Tc is computed by summing all the travel times for consecutive components of the drainage conveyance system. Figure 3-5 shows an example watershed split to 3 flow types, sheet (section AB), shallow (section BC), and open channel (section CD).

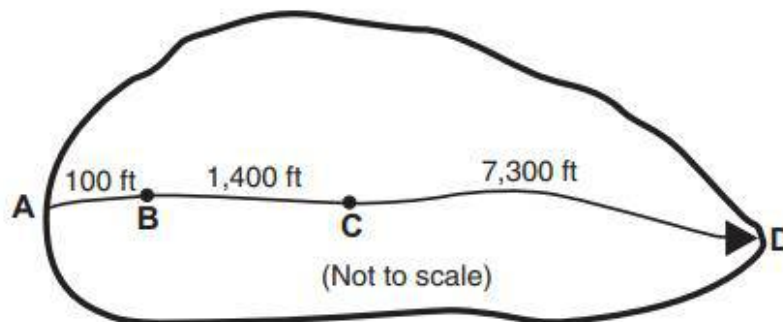

Figure 3- 5: Example Subbasin with Tc flow path designations

The Velocity Method shall be used as specified in TR 55 for analyses requiring unit hydrograph method where:

**Equation 3- 9: Time of Concentration – Velocity Method**

$$T_c = t_{\text{sheet}} + t_{\text{shallow}} + t_{\text{channel}}$$

Where sheet flow of less than 300 feet, uses Mannings kinematic solution to compute  $T_t$ :

**Equation 3- 10: Travel Time for sheet flow**

$$T_t = \frac{0.007(nL)^{0.8}}{(P_2)^{0.5}S^{0.4}}$$

$T_t$  = travel time (hr)

$n$  = Mannings roughness coefficient (utilizing Mannings N roughness coefficients for sheet flow, Table 3- 10)

$L$  = flow length (ft)

$P_2$  = 2-year, 24-hour rainfall (in)

$S$  = slope of hydraulic grade line (land slope, ft/ft)

**Table 3- 11: Roughness coefficients for sheet flow from TR-55**

Surface Description	$n^1$
Smooth Surfaces (concrete, asphalt, gravel or bare soil)	0.013
Fallow (no residue)	0.05
Cultivated Soils	
Residue Cover $\leq 20\%$	0.06
Residue Cover $> 20\%$	0.17
Grass	
Short grass prairie	0.15
Dense Grasses <sup>2</sup>	0.24
Bermudagrass	0.41
Range (natural)	0.13
Woods <sup>3</sup>	
Light Underbrush	0.40
Dense Underbrush	0.80

1. The  $n$  values are a composite of information compiled by Engman (1986)
2. Includes species such as weeping lovegrass, bluegrass, buffalo grass, blue grama grass, and native grass mixtures.
3. When selecting  $n$ , consider cover to a height of about 0.1 ft. This is the only part of the plant cover that will obstruct sheet flow.

For shallow and open channel flow (for anything over 300 feet use the travel time of the ratio of flow length to flow velocity), travel time is calculated by Equation 3-11.

**Equation 3- 11: Travel Time for Shallow and Open Channel Flow**

$$T_t = \frac{L}{3600V}$$

Tt = travel time (hr)

L = flow length (ft)

V = average velocity (ft/s)

3600 = conversion factor from seconds to hours

Where a velocity can be found utilizing the same equation as Equation 3-5 or:

**Equation 3- 12: Mannings Equation Average Velocity**

$$V = \frac{1.486}{n} R^{\frac{2}{3}} S^{\frac{1}{2}}$$

V = Average velocity for section for the entire drainage waterway, in feet per second.

R = Hydraulic radius (Flow Area divided by Wetted Perimeter, in square foot per foot.)

S = Average slope of the waterway gradient, in foot per foot.

### 3.4.3 Lag Time

For SCS Unit Hydrograph transformation, a required input is the basin lag time which is computed to be 60% of the basins Time of Concentration:

**Equation 3- 13: Lag Time**

$$T_L = 0.6T_c.$$

T<sub>L</sub> = Lag time

T<sub>c</sub> = Time of Concentration determined from Equation 3- 9

### 3.4.4 Rainfall Distribution

The Frequency Distribution Storm at 25% Intensity Position shall be used as the default rainfall distribution method. Precipitation depths for the appropriate watershed shall be acquired at the centroid of the watershed from NOAA Atlas 14.

## **SECTION 4. PAVEMENT DRAINAGE**

---

1. The longitude street slopes shall not be less than 0.5 percent.
2. Cross slope shall not exceed 2.0 percent slope.
3. For streets with an inverted crown, a traffic rated concrete valley gutter is required. For rehabilitation of a street with an inverted crown, a concrete valley gutter shall be placed if not already part of an existing street. The concrete valley gutter shall be placed centered on the invert with a minimum of 2-feet on each side of the invert (minimum 4-foot width).
4. All runoff water within curb and gutter shall be captured in an inlet prior to crossing any intersection.

## **SECTION 5. STORM SEWER PIPE**

---

1. Asbestos concrete, non-reinforced concrete, or galvanized metal pipe cannot be used for storm drainage applications.
2. For use of junction boxes and drop inlets, refer to the Drainage Details.
3. The last two segments of pipe, when entering retention/detention pond and drainage channel, must be reinforced concrete pipe.

### **5.1 VELOCITIES**

#### **5.1.1 Minimum**

The minimum permissible velocity is three (3) feet per second. Very low velocities encourage sedimentation.

#### **5.1.2 Maximum**

The maximum allowable velocity is fifteen (15) feet per second within the pipe.

## SECTION 6. OPEN CHANNEL

---

### 6.1 VELOCITIES

#### 6.1.1 Minimum Velocity

The minimum permissible velocity is three (3) feet per second.

#### 6.1.2 Maximum Velocity

The maximum permissible velocity is as shown below:

1. Concrete – twenty (20) feet per second.
2. Earthen (including sand, loams, clays, etc.) – three (3) feet per second
3. Gravel or rip rap lined – five (5) feet per second and must include geotextile fabric
4. Gabion lined (mattress or basket) – twelve (12) feet per second.

Any other materials used to line the channel must be approved by the El Paso City Engineer prior to use. For public safety, open channels shall be protected with fencing and with proper hazard signage.

### 6.2 CHANNEL ACCESS FOR MAINTENANCE

- At a minimum, a 12-foot maintenance access lane with an access ramp is recommended to be provided on at least one side of a channel for maintenance of channels. Turnouts and access ramps will be provided as necessary for complete access to the channel throughout its entire length with a maximum of ½ mile intervals. Turnarounds must be provided at all access road dead ends. Ingress and egress from public right-of-way and/or easements to the channel maintenance and access road must be provided.
- For concrete lined channels, ramps shall be constructed of 8-inch-thick reinforced concrete, will not have slopes greater than 12 percent, and shall not enter the channel at angles greater than 15 degrees from a line parallel to the channel centerline.
- For unlined channels, maintenance and access roads shall be surfaced with 6 inches of base course material.
- Ramps will be constructed on the same side of the channel as the maintenance and access road. The maintenance and access road shall be offset around the ramp to provide for continuity of the road the full length of the channel. The downhill direction of the ramp should be oriented downstream.
- To minimize maintenance, paths, walkways, play areas, and irrigation systems should be in a less frequently inundated portion of the channel. Bottom widths of channels should be designed in consideration of maintenance requirements for the channel lining and will be no narrower than 8 feet, unless otherwise approved by the jurisdictional entity.

- The selection of a channel treatment type should include analyses of both short- and long-term maintenance. While maintenance efforts will vary between treatment types, all facilities should be able to function through one runoff event with no maintenance, through one flood season with very little maintenance, and from season to season with regular, but minimal maintenance requirements.

## **SECTION 7. CULVERTS**

---

Culverts design shall be provided at time of plan submittal. Accepted software programs for culvert design include:

- Culvert Master
- HY-8
- HEC-RAS
- Civil 3D
- Hydroflow

Minimum velocity allowed is three (3) feet per second. Maximum velocity allowed is twenty (20) feet per second. Outlet velocity shall be six (6) feet per second. When discharging into a pond, velocities above three (3) feet per second require energy dissipation and erosion control at outfall. All culverts shall be simulated with a 20% clogging factor to account for sediment and debris accumulation.

## **SECTION 8. BRIDGES**

---

### **8.1 SCOUR**

Developer and/or contractor shall provide scour calculations for the following:

- Open Channels
- Pond Inlets
- Culvert inlets and outlets
- Arroyos
- Waterways
- Floodplains

Calculations shall be submitted with improvement plans. Energy dissipation for channels and culverts shall follow guidelines in HEC-14. Bridge scour, horizontal, and vertical channel stability shall follow guidelines in HEC-18, 22 and 23.

### **8.2 FREEBOARD**

Freeboard at a bridge is the vertical distance between the design water surface elevation and the low chord of the bridge. The bridge low-chord is the lowest portion of the bridge deck superstructure. The purpose of the freeboard is to provide room for the passage of floating debris, extra area for conveyance if debris build up on the piers reduces hydraulic capacity of the bridge, and a factor of safety against the occurrence of waves or floods larger than the design flood. A minimum freeboard of two (2) feet for the 100-year event is required. The structural design of the bridge should consider the possibility of debris and/or flows impacting the bridge. In certain cases, site condition or other circumstances may limit the amount of freeboard at a particular bridge crossing. An example would be the replacement of a “perched” bridge across a natural watercourse where major flows overtop the roadway approaches. In general, the Storm Water Utility or Floodplain Administrator will evaluate variances to the minimum freeboard requirement on a case-by-case basis.

All bridge design and analysis will require a HEC-RAS 1D hydraulic model. Long term channel degradation, local, abutment, and pier scour must be evaluated as part of the design analysis report per TXDOT or HEC-18-23 procedures.

### **8.3 SUPERCritical FLOW**

For the special condition of supercritical flow within a lined channel, the bridge structure should not affect the flow at all. That is, there should be no projections, piers, etc. in the channel area. The bridge opening should be clear and permit the flow to pass unimpeded and unchanged in the cross-section.



## **8.4 ADDITIONAL DESIGN CONSIDERATIONS**

Drainage structures over the concrete-lined channel should be of all-weather type e.g., bridges, culvert pipe, or concrete box culverts. Crossing structures should conform to the channel shape so they disturb the flow as little as possible.

It is preferred that the channel section be continuous through crossing structures. However, when this is not practicable, hydraulic disturbance shall be minimized and crossing structures should be suitably isolated from the channel lining with appropriate joints.

## **8.5 MINIMUM CLEAR HEIGHT**

Channel lining transitions at bridges and box culverts should conform to the provisions for transitions hereinafter provided. Drainage structures having a minimum clear height of 8 feet and being of sufficient width to pass maintenance vehicles may result in minimizing the number of required channel access ramps. Maximum spacing between ramps shall be 2,500 feet. A minimum of one ingress and one egress between intersections is required.

# **SECTION 9. STORMWATER BASIN**

---

## **9.1 GENERAL**

In developing areas where runoff increases due to the creation of more impervious land area than historic conditions, storm water storage is necessary to flood hazard mitigation. The purpose of this section is to provide uniform minimum criteria for the design of safe, effective, and easily maintained public and private basins. Basins are required if there is any increase of runoff due to development of the area. In areas where a negative outfall occurs (flat areas where slope is less than 2%, unsafe conveyance, sediment obstruction), ponding shall be designed to retain historic and developed volume.

## **9.2 DEFINITIONS**

The terms detention and retention basins are often used interchangeably. However, each represents a very different type of storm water ponding. For each type of facility, the following definitions from the American Society of Civil Engineers (ASCE, 1992) will be used in this manual.

1. Detention – The temporary storage of flood water that is usually released by a measured controlled outlet. Detention facilities typically flatten and spread the inflow hydrograph, lowering the peak.
2. Retention – Storage provided in a facility without a positive outlet, where all or a portion of the inflow is stored for a prolonged period. Infiltration basins are a common type of retention facility.

### **9.3 OBJECTIVES**

The objective for managing storm water quantity by storage facilities are typically based on complying with one or more of the following values:

1. Historic rates for a specific design condition.
2. Non-hazardous discharge capacity for the downstream drainage system.
3. A specified value for allowable discharge set by the local drainage authority.

For a watershed with no positive outfall, the existing and developed runoff volume shall be retained on site.

### **9.4 GUIDELINES FOR STORM WATER PONDING**

The following general guidelines apply to the design of storm water ponding facilities.

#### **9.4.1 Pond Geotechnical Engineering Evaluation**

Geotechnical soil evaluation shall be performed for proposed new ponds for commercial and residential developments. Geotechnical report shall include subsurface exploration boring plan, boring logs, laboratory engineering soil classification test results for collected samples during drilling operations, ground water depth or water seepage depth information, groundwater depth fluctuation data, soil percolation and/or infiltration test data, pond slope design considerations, pond slope stability considerations, excavation safety considerations and recommendations for controlling pond slope erosion based on collected geotechnical information. Geotechnical report shall be prepared by an active licensed engineer in the State of Texas.

##### **9.4.1.1 Subsurface Exploration Vertical Boring Data:**

1. Perform a minimum of three (3) soil borings to a minimum depth of ten (10) feet beyond the projected pond invert unless otherwise directed by the project engineer. Soils borings should be performed for delineation of the subsurface stratigraphy within the pond footprint and for soil classification purposes per industry standard ASTM methods.
2. Perform soil borings to the depth of encountered relatively free-draining and permeable soils layers.

##### **9.4.1.2 Soil Classification:**

Collected samples from exploration vertical borings shall be classified in accordance with ASTM D 2487 for each encountered material type. A minimum of two (2) material classification tests shall be performed per boring. Classification tests shall include soil particle size analysis tests, Atterberg limit tests, moisture contents, soil-moisture density relationship tests and engineering soil classifications in accordance with ASTM D 2487. Test results shall be reported on boring logs.

#### **9.4.1.3 Groundwater:**

1. Groundwater table depth shall be reported; including current data of seasonal changes and shall be monitored within the on-site pond. Development sites where the pond depth is expected to be five (5) feet or less from the highest anticipated groundwater depth shall require the installation of a monitoring well to collect groundwater depth fluctuations for at least a period of twelve (12) months.
2. Monitoring wells or piezometers shall be installed to a minimum depth of five (5) feet below the encountered water table depth.

#### **9.4.1.4 Subsurface Soil Percolation Test:**

Refer to ASTM D5093.

### **9.4.2 Storage Capacity**

#### **9.4.2.1 Retention Facilities**

A retention basin shall be designed to have storage capacity to retain the following components:

1. 100-year 24-hour design storm plus a 30 percent safety factor added to the total inflow volume to account for back-to-back storm events. For example, if the computed retention volume is 10-acre feet, then an additional 3 acre- feet of storage volume must be included as part of the retention ponds design volume.

#### **9.4.2.2 Detention Facilities**

A detention pond shall be designed to have storage capacity to detain the following components:

1. Basins to be designed utilizing good engineering practices and accepted methods (such as HEC-HMS) whereby 100% of the runoff volume is to be properly managed using channels, outfalls and conduits.

Reservoir routing results shall be submitted for pond analysis to ensure that pond design meets design criteria and non-jurisdictional status.

## **9.5 BASIN GEOMETRIC CONTROLS**

### **9.5.1 Shape**

As a general rule, curvilinear, irregularly shaped facilities will have the most natural character. A wide range of shapes can be considered and utilized to integrate the storm water ponding facility with the surrounding site development. Smooth curves should be used in the plan layout of the grading for the facility.

### **9.5.2 Side Slopes**

Basin side slopes shall not exceed 3 horizontal to 1 vertical (3H:1V). All basin plans require a soil investigation report performed by a licensed geotechnical engineer. The soils investigation report shall contain the following minimum requirements:

1. Soils analysis describing engineering properties and suitability of the existing soils to support the proposed slope.
2. Erosion control measures.
3. Slope stability analysis showing the failure plane and a minimum factor of safety of 1.25 for non-supporting structural slope and 1.5 for slope supporting structure.

Ponds with high water greater than 2 1/2ft and with side slopes greater than 12 percent shall be enclosed with a minimum 6-foot-high screening wall. The height of the wall shall be measured from the ground inside or outside the wall, whichever is higher. The screening wall may consist of rock-wall, Concrete Masonry Unit (CMU) wall, combination of rock-wall and wrought iron, wrought iron, or other materials as approved by the County Administrator.

If a screening wall is required, an 18-foot-wide minimum wrought iron double gate accessible from public right-of-way is required. The gate location is to be approved by the El Paso Water Utilities. Gates shall be set back a minimum of 50 feet from Arterial and Collector streets, so equipment does not have to park in the street. The gate shall swing inward and not obstruct the maintenance road or other materials or opening.

#### **9.5.2.1 Stabilization of Pond Slopes**

Earthen slopes shall be protected against wave action and surface water flows with appropriate armor. Armor shall consist of rock riprap, cast-in-place concrete lining, or other stabilization measures approved by the City of El Paso. The following items shall be considered in design to mitigate localized slope erosion and improve the overall stability of the pond slopes.

Earthen pond slopes that meet the specified soil material physical composition shall not exceed three (3) horizontal to one (1) vertical. The depth of suitable soils above the cut pond slopes shall be a minimum of eighteen (18) inches. Earthen pond slopes that shall be steeper than 3:1 (Horizontal : Vertical) and including geotechnical data indicating that the native soils are susceptible to erosion and sloughing, shall require armoring and/or stabilization of earthen pond slopes. The submitted development plans shall include details and specifications for the specified stabilization and/or protection of earthen pond slopes. The following is a Table of earthen slope protection guideline methods.

**Table 9- 1: Pond Slope Armor Protection / Stabilization Guidelines**

Side Slope Ratio (H:V)	Protection / Stabilization Method
3:1 or flatter	<ul style="list-style-type: none"> <li>➤ Compacted Suitable Soils above Cut Slopes, soils conforming to Section 9.5, compact soils per Section 9.5.2</li> </ul>
No steeper than 2:1	<ul style="list-style-type: none"> <li>➤ Rock Rip Rap</li> <li>➤ Approved Rock material 4 to 12 inches with geofabric [1]</li> <li>➤ Gabions [1]</li> <li>➤ Concrete Rip Rap</li> </ul>
No steeper than 1:1	<ul style="list-style-type: none"> <li>➤ Concrete Rip Rap Lined Slopes</li> </ul>
Steeper than 1:1	<ul style="list-style-type: none"> <li>➤ Concrete Retaining Wall Structure</li> <li>➤ Natural Rock Formations with minimum compressive strength of 4,700 psi</li> </ul>

**Note [1]:** Submittal of manufacturer specifications, installation procedures, list of completed projects with material maintenance requirements and warranty exclusions are required.

1. Vegetation may be planted on a basin floor or on a basin side slope that is 3:1 or flatter except in areas within a 20-foot radius of the basin inlet, outlet or maintenance access ramp. Plants on the perimeter of a basin shall not obstruct drainage entering or exiting the on-site pond.
2. All pond earthen slopes shall be compacted as per Section 9.5.2.5 prior to placement of protection armor or stabilization materials.
3. A general slope stability analysis shall be submitted with development plans.

**9.5.2.2 Pond Slope Stabilization**

1. Concrete rip rap lining along pond slopes may be considered to mitigate erosion of the pond slopes. Concrete lining shall be designed by an active licensed professional engineer in the State of Texas. The concrete liner shall have a minimum thickness of 5 inches. The final thickness of the liner shall be determined by a professional engineer. The concrete liner shall specify grade beams and counterforts to maintain the liner stable. The concrete liner shall be reinforced with steel rebar and meet the requirements of ASTM A615, Grade 60. Concrete strength shall be a minimum of 3,600 psi at 28-days. Pond design plans with concrete rip-rap lining shall include complete plan and profile details, reinforcement details, jointing pattern details, placement sequence plan, applicable formwork information and construction inspection requirements and documentation. Inspections

shall be performed by an independent party. Inspection and construction reports shall be submitted to the City of El Paso during construction of the specific project.

2. The specification of a geo-fabric or erosion control blanket along the face of the slopes shall be submitted for review. Pond design drawings shall include installation orientation and overlapping details, jointing and anchoring details, placement sequence plan, applicable site preparation information, construction inspection requirements, quality assurance documentation, geo-fabric or carpet product manufacturer information, maintenance requirements and warranties. A letter shall also be provided by the manufacturer that the specified product shall perform well for the specific development project and any required special conditions.
3. Slope Rock Rip-Rap Material- Loose rock riprap specified on slopes to reduce erosion shall be chemically resistant, angular stone, durable (exhibit an LA Abrasion not greater than 40), non-weathered, and uniform in size ( $d_{50}$ ). The slope angle should also be considered in the final design to ensure that the loose rock riprap shall be stable. A geo-textile filter fabric should be specified between the finished slope surface and placed rock material. A sample of the rock material shall be submitted to the City of El Paso for review and approval prior to placement on slopes.
4. Geotextile Filtration Material – Geotextile filter material shall be a nonwoven pervious sheet of polymeric material. Geotextiles chemically resistant to the conditions it will be exposed to. Material submittals shall include complete design data, product data sheets, staple pattern guides, installation guidelines, manufacturing material specifications, manufacturing certifications, cad details, and manufacturing quality control program. The manufacturer shall also provide a test report providing data showing the performance capabilities of the geotextile along with reference installations similar in size and scope as specified for the project.

### **9.5.2.3 On-site pond access ramps**

This section provides the minimum requirements for reasonable access for maintenance and inspection activities within the pond.

1. Pond ramps shall be constructed with approved non-permeable or Structural Fill soil material to maintain the access ramp stable and suitable for use after being in a submerged condition. The driving surface of the ramp shall contain a minimum of 8 inches of compacted Structural Fill. Structural Fill shall also be specified along perimeter access roads and intermediate benches along the slope.
2. Pond ramp design shall specify a minimum horizontal width of twelve (12) feet, a minimum vertical clearance of fourteen (14) feet from existing and above grade specified objects or utility lines, an inside turning radius of no less than thirty-six (36) feet, a maximum longitudinal slope of fifteen (15) percent, a maximum transverse slope of five (5) percent, a maximum vertical grade break of twelve (12) percent, and a maximum vertical curve grade change of one (1) percent per horizontal foot.

**9.5.2.4 Requirements for fill materials**

Structural fill and/or engineered fill shall consist of a crushed stone base (CSB) coarse material conforming to requirements of a TXDOT Item 247 – Flexible Base, Type A, Grade 3 soil material. The flexible base material shall meet the gradation requirements below and exhibit a plasticity index of 12 or less. The flexible base material shall also exhibit a maximum dry density of at least 140 pcf determined in accordance with ASTM methods.

**Table 9- 2: Structural Fill - Base Coarse Material Gradation Requirements**

Sieve Size (Square opening)	% Passing by Weight
2½ -inch	100
1¾ -inch	90 – 100
No. 4	25 – 55
No. 40	15 – 50

Alternative engineered fill soils shall consist of granular sandy soils or gravel mixtures, free of clay lumps, deleterious materials, organic material, cobbles or boulders over 3 inches in nominal size. The alternative engineered fill shall have a liquid limit less than 35 and a plasticity index from 3 to 12. The alternative engineered fill shall also exhibit an optimum dry density of at least 130 pcf determined in accordance with ASTM methods. Alternative engineered fill soils shall also meet the gradation requirements below.

**Table 9- 3: Alternative Engineered Fill Gradation Requirements**

Sieve Size (Square opening)	% Passing by Weight
3-inch	100
¾-inch	85 – 100
No. 4	45 – 85
No. 200	13 – 45

Alternative structural fill soils shall classify as SC, SC-SM, GC, and GC-GM in accordance with the Unified Soil Classification System (USCS).

**9.5.2.5 Requirements for compaction**

Compact with approved tamping rollers, vibrator compactors, or other approved equipment (hand or mechanized) well suited to slope soil being compacted.

1. All embankments, fills, slopes shall be compacted to 95% of maximum density as per ASTM D1557. The in-place field density shall be determined in accordance with ASTM standard methods. Stones or rock fragments larger than 4 inches in their greatest dimension will not be permitted in the top 6 inches of the subgrade.
2. Do not operate mechanized vibratory compaction equipment within the City of El Paso without prior approval of project engineer. Moisten or aerate material as necessary to provide moisture

content that will readily facilitate obtaining specified compaction with equipment used. Compact soil to not less than the following percentages of maximum dry density, according to ASTM D1557 as specified.

#### **9.5.2.6 Dewatering**

1. If dewatering is required to construct ponds in order to remove low permeability soils below the groundwater depth, the dewatering system should be designed by a licensed professional engineer familiarized with the hydro-geologic conditions of the area.
2. Groundwater or perched water draw down rates and reestablishment rates should be carefully considered by the dewatering system designer and dewatering contractor and potential impact to surrounding structures. The designer should also consider if there is a need to re-inject removed subsurface water during dewatering operations.
3. The following are general minimum requirements that should be considered in the preparation of a dewatering plan, but not limited to these sole requirements if necessary.
  - a. The general contractor shall design, provide, and operate dewatering system to include sufficient trenches, sumps, pumps, hose, piping, well points and similar facilities, necessary to depress and maintain groundwater level twenty-four (24) inches below the base of each excavation during all stages of construction operations.
  - b. Design and operate dewatering system to avoid settlement and damage to existing structures and underground facilities.
  - c. Groundwater table shall be lowered in advance of excavation for a sufficient period of time to allow dewatering of fine grain soils.
  - d. Operate dewatering system, continuously, twenty (24) hours per day, seven days per week. Provide standby pumping facilities and personnel to main the continued effectiveness of the system. Do not discontinue dewatering operations without first obtaining the contractor engineer's acceptance for such discontinuation.
  - e. If, in the engineer's opinion, the water levels are not being lowered or maintained as required, provide additional or alternate temporary dewatering devices as necessary.
  - f. Where portions of dewatering system are located in the area of permanent construction, submit to and obtain, general contractors design engineer's acceptance of details of proposed methods of constructing the work at such location.
  - g. Perform pumping of water from excavations in a manner that prevents carrying away of unconsolidated concrete materials, and that avoids damaging the subgrade.
  - h. Before discontinuing dewatering operations or permanently allowing the gradual rise of groundwater levels, prepare computations to demonstrate that structures affected by the water level rise are protected by fill or other means to sustain uplift.



- i. The general contractor’s dewatering system shall discharge to suitable locations acceptable to owner including owners adjacent to and downstream of dewatering system discharge. Operation of the dewatering system and disposal of water shall be in accordance with Laws and Regulations. The need for reinjection of water shall also be consider in the design of the dewatering plan.
- j. Convey water from excavations in pond in closed conduits. Do not use trench excavations as temporary drainage ditches.
- k. Dispose of water removed from excavations in a manner that does not endanger health and safety, property, the work, and other portions of the project at all times.

### **9.5.3 Depth and Bottom Configuration**

Maximum depth of basins shall be limited to 20 feet. The horizontal clearance at the bottom of the pond shall be a minimum of 25 feet diameter. For a detention basin, the bottom shall be designed to drain though low flow channel. Basins with tiered invert and soil erosion protection shall be designed to minimize erosion between tiers.

A dam will become jurisdictional if it meets one or more of the following four criteria:

1. Have a height greater than or equal to 25 feet and a maximum storage capacity greater than or equal to 15 acre-feet
2. Have a height greater than 6 feet and a maximum storage capacity greater than or equal to 50 acre-feet.
3. Are a high- or significant-hazard dam as defined in §299.14 (relating to Hazard Classification Criteria), regardless of height or maximum storage capacity; or
4. Are used as a pumped storage or terminal storage facility.

Low flow is required in the bottom of a detention basin to provide positive routing of drainage to the primary outlet structure. Low flow shall have a 0.5% maximum longitudinal slope.

### **9.6 DRAIN TIME**

The pond must drain down within 72 hours, either by infiltration or by means of an outlet. If the entire 24-hour storm volume cannot be infiltrated in 72 hours, the design storm shall be increased to exceed the duration of the total infiltration of the design volume.

### **9.7 LINING/SURFACE TREATMENT**

Basins must be designed to prevent concentrated run-off to flow onto unstable side slopes of the basin. The basin shall be designed to allow concentrated run-off from perimeter maintenance road to flow into basin only though a stabilized section of the basin side slopes. The use of inert materials are required for stabilization and erosion control where at inflow points, at the outlet control structure, and any other location where flowing water may threaten stability. Use of these materials should be properly engineered and should respond to aesthetic considerations. Inert materials for erosion control include:

1. Loose rock riprap with a specific, engineered gradation.
2. Loose or grouted boulders (minimum dimension 18 inches or larger).
3. River stone.
4. Gabions.
5. Soil cement and concrete.

Stormwater facilities may be used as amenities that incorporate multiple use concepts where possible and permissible by maintaining entity, grass and/or landscape plantings are preferred surface treatments. Grass and plant species used for landscaping should be native to the region. If landscaping is utilized, permanent irrigation systems may be required for grass areas and most landscaping. A registered landscape architect should prepare the landscape design with consideration toward use of plant species appropriate for the level and frequency of inundation of the ponding facility. Designs that combine both landscape planting with the use of inert materials is recommended.

## **9.8 SUBSURFACE DISPOSAL**

The primary method for underground disposal of storm water runoff at retention ponds are basin volume capacity. Infiltration rates of basins shall not be used in determining basin stormwater capacity.

## **9.9 DRYWELL**

Drywells shall not be used for subsurface disposal of storm water.

## **9.10 SPILLWAYS**

A typical detention basin facility has two spillways: principal and emergency. A typical detention basin facility must have an emergency spillway to help direct flood events in a planned manner.

## **9.11 PRIMARY**

The principal spillway structure allows flows to discharge from the detention pond at a controlled rate. The principal outflow from detention basin shall be an overflow tower with an outflow pipe. The principal outlet structure, called the primary spillway, is intended to convey the design storm without requiring flow to enter an emergency spillway. Outlets can be designed in a wide variety of configurations depending on the desired release rates. This may be accomplished using multi-stage control structures. If a multi-stage control structure satisfies the upper and lower discharge requirements, discharges from intermediate storm return periods can usually be assumed to be adequately controlled. Minimum pipe diameter for a principal outlet pipe shall be 24- inch RCP.

## **9.12 EMERGENCY**

For the 100-year 24-hour storm, the dam shall have 1 foot of freeboard to the invert of the emergency spillway.

The emergency spillway shall be designed pass flows up to 100% of the 500-year storm and/or meet TCEQ requirements if the dam falls under jurisdictional criteria without overtopping the top of dam. The emergency spillway shall pass the 500-year flows while maintaining a minimum freeboard of 12 inches.

### **9.13 MAINTENANCE CONSIDERATIONS**

Proper design should focus on the reduction of maintenance requirements by addressing the potential for problems to develop.

1. Both weed growth and grass maintenance may be addressed by constructing side slopes that can be maintained using available power-driven equipment, such as tractor mowers.
2. Sedimentation may be controlled by constructing traps to contain sediment for easy removal, by low-flow channels to reduce erosion and sediment transport by frequent or continuous flows.
3. Outlet structures should be selected to minimize the possibility of blockage.

An access ramp meeting the following criteria will be provided for all storm water pond facilities:

1. Maximum slope of 12%.
2. Minimum width of 15 feet.
3. Ramp material will consist of a maximum P.I. of 8 with no loose material and a compacted drivable surface. (6" Base Material)
4. Compaction will be at a minimum 95% per ASTM D-1557.
5. A depth gauge shall be required for ponds deeper than 2 feet.

For on-site ponding, elevation marker is required for ponds up to 1ft deep or properties larger than 1 acre

## **SECTION 10. OTHER HYDRAULIC ELEMENTS**

---

### **10.1 CHANNEL DROP STRUCTURE**

Drop structures are commonly used for flow control and energy dissipation. Drop structures may be used to reduce the effective slope of a natural or artificial channel. Changing the channel slope from steep to mild, by placing drop structures at intervals along the channel reach, changes a continuous steep slope into a series of gentle slopes and vertical drops. The kinetic energy or velocity gained by the water as it drops over the crest of each structure is dissipated by a specially designed apron or stilling basin.

A drop structure typically extends across the entire width of the channel and provides grade control for a full range of flows. Check structures are similar in concept, but their objective is to stabilize and control the channel bed or low flow zone. During a major flood, portions of the flow circumvent the structure, but erosion is maintained at an acceptable level. Overall stability is maintained by control of the low flow area, which would otherwise degrade downward. A series of check structures can be an economical interim grade control measure for natural channels in urbanizing areas or for artificial channels where funding is inadequate for construction of drop structures. Channel drop structures shall follow guidelines from HEC-14.

## **10.2 APPLICATION OF DROP STRUCTURES**

Drop structures or check dams may be constructed of rock, gabions, concrete, timber, sacked concrete, filled fences, sheet piling, or combinations of any of the above. Drop Structures are most suited to locations where bed materials are relatively impervious; otherwise, underflow must be prevented by cutoffs. The designer is referred to HDS-6 for further discussion on the use of drop structures. Channel drop structures shall follow guidelines from HEC-14.

## **10.3 ENERGY DISSIPATION STRUCTURES**

Concrete energy dissipation or stilling basin structures are required to prevent scour damages caused by high exit velocities and flow expansion turbulence at conduit outlets. Outlet structures can provide a high degree of energy dissipation and are generally effective even with relatively low tailwater control. Rock protection at conduit outlets is appropriate where moderate outlet conditions exist; however, there are many situations where rock basins are impractical even at low to moderate flow conditions. Concrete outlet structures can be designed easily and are suitable for a wide variety of site conditions. In some cases, they are more economical than large rock basins, particularly where long term costs are considered.

It is recommended that designers refer to HEC-14 and HDS-4 for further discussion of energy dissipation structures. Energy dissipation calculations shall be provided with improvement plans. Gabions or large loose rock shall be placed at outlet structures.

## **10.4 DEBRIS BARRIERS**

A debris barrier or deflector is a means of preventing large debris or trash, such as tree limbs, logs, boulders, weeds, and refuse, from entering a storm drain and possibly plugging the conduit. The debris barrier should have openings wide enough to allow as much small debris as possible to pass through yet narrow enough to protect the smallest conduit in the system downstream of the barrier. One type that has been used effectively in the past is the debris rack. This type of debris barrier is usually formed by a line of posts, such as steel pipe filled with concrete or steel rails, across the line of flow to the inlet. Other examples of barriers are presented in Hydraulic Engineering Circular No. 9, "Debris-Control Structures," published by the FHWA, which is available at the FHWA website ([www.fhwa.dot.gov](http://www.fhwa.dot.gov)). It will be the designer's responsibility to provide a debris barrier or deflector appropriate to the situation.

## **10.5 SEDIMENT BASINS**

Sediment basins, check dams, and similar structures are a means of dropping out sediment held in suspension. Sediment basins constructed upstream of storm drain conduits help trap such material before it reaches the conduit. Sediment basins must be cleaned out on a regular basis in order to function effectively.

## **SECTION 11. SEDIMENT TRANSPORT**

---

### **11.1 PURPOSE AND NEED**

#### **11.1.1 Sediment and Debris Mechanisms**

##### **11.1.1.1 Routine Sediment Deposition**

Routine sediment deposition is a common problem in the El Paso area due to the high intensity precipitation that the area receives, the numerous topographic transitions from steep to flatslopes, and the sandy soils that are present. The precipitation and the resulting runoff dislodge particles from the sandy soils and transport them to downstream arroyos. The arroyos transport the sediment to downstream portions of the watershed, while contributing additional sediment eroded from arroyo bed and banks. The combined sediment load is ultimately deposited at locations of decreased velocity (i.e., stormwater infrastructure locations, breaks in slope, etc.).

##### **11.1.1.2 Debris Flow Events**

Although not as common as routine sedimentation, debris flow events are a problem in the El Paso Area, as demonstrated in the August 2006 floods. Debris flow events generally result from prolonged intense precipitation and initiate on the steep slopes in the upper portion of the watershed. Prolonged rainfall results in saturation of sediment and debris historically accumulated within arroyo beds. Saturation can ultimately lead to liquefaction of these sediment/debris, with sudden release of the full sediment/debris load downstream. As the sediment/debris flow moves down through the watershed additional sediment and debris is incorporated in the load. The combined sediment load is ultimately deposited at locations of decreased velocity (i.e., stormwater infrastructure locations, breaks in slope, etc.). This rare event results in much larger volumes of transported sediment/debris than routine erosion-based sediment deposition.

#### **11.1.2 Sediment and Debris Hazards**

There are several hazards associated with routine sediment deposition and debris flow events. The results of these hazards can generally be classified as indirect damage or direct damage.

##### **11.1.2.1 Indirect Damage Resulting from Sediment and Debris Hazards**

Indirect damage to property occurs when sediment or debris causes downstream infrastructure to function improperly and causes flooding that impacts property. Indirect damage generally occurs at areas of reduced velocity where deposition occurs. The deposited sediment reduces the capacity of the drainage structure, resulting in flooding of adjacent and downstream structures.

##### **11.1.2.2 Direct Damage Resulting from Sediment and Debris Hazards**

Direct damage to property occurs when sediment or debris comes into direct contact with property. Direct damage generally affects drainage structures located in channels or arroyos, structures located at or near the mouth of an arroyo or the outfall of a channel, or structures located adjacent to arroyos or channels.

### **11.1.3 Purpose**

The purpose of this section of the SWDM is to:

1. Identify design criteria to reduce negative impacts from sediment deposition and debris flows; and
2. Develop and specify design criteria to control routine sedimentation and debris flows.

### **11.2 DESIGN CRITERIA SOURCES AND TYPES:**

A number of sources were consulted as background for this section. These sources consisted primarily of design manuals for arid counties with soil types and topography similar to El Paso. The most useful sources are listed below:

- Clark County Regional Flood Control District (CCRFCD) Hydrologic Criteria and DDM (CCRFCD, 1999);
- Maricopa County Hydraulics DDM (Maricopa County, 2010);
- Mohave County DDM (Mohave County, 2009);
- Pinal County DDM (Pinal County, 2004);
- Pima County Department of Transportation & Flood District (PCDOT & Flood Control District [FCD]), Stormwater Detention and Retention Manual (PCDOT & FCD, 1987);
- Southern Sandoval County Arroyo Flood Control Authority (SSCAFCA) Sediment and Erosion Design Guide (Mussetter Engineering Inc. [MEI], 2008);
- Sparks Arroyo Flood Control Project Draft Sediment Appendix (USACE, 2004- 2007);
- International Boundary and Water Commission (IBWC) Rio Grande Canalization Improvement Project, Sedimentation Analysis from the Rio Grande Tributary Basins (USACE and Resource Technology Inc. [RTI], 1996); and

From the sources listed above the following types of sediment design criteria were identified:

- Sediment basin design criteria;
- Channel design criteria;
- Culvert design criteria; and
- Storm drain system design criteria.

### **11.3 SEDIMENT BASIN DESIGN CRITERIA**

All sediment basins shall be designed to contain a minimum of ten years of average annual sediment yield volume from the contributing watershed and with a layout similar to Figure 11-1. There are three different levels of analysis that can be utilized to estimate the average annual sediment yield. Each level of analysis provides the user of the manual an approved method for estimating the sediment yield, with a varying degree of required effort and site-specific

consideration associated with each level. General descriptions of each of the three levels of analysis are provided below.

- Level I: Default method incorporating minimal site-specific considerations.
- Level II: More detailed method incorporating site specific considerations but requiring more detailed analysis.
- Level III: Mechanism to allow other methods, approved by the CoEP, to be utilized.

Sediment basin locations at risk from debris/sediment flows require additional design consideration. All sediment basin locations within proximal or medial alluvial fan zones and immediately downstream of areas identified as known or potential debris/sediment flow sources must be designed to accommodate the additional volume associated with the potential debris/sediment flow. There are two different levels of analysis that can be utilized to estimate the debris/sediment flow volume required.

Sediment basins constructed along arroyos in El Paso may require additional environmental considerations. Section 12 provides information on permitting for this topic.

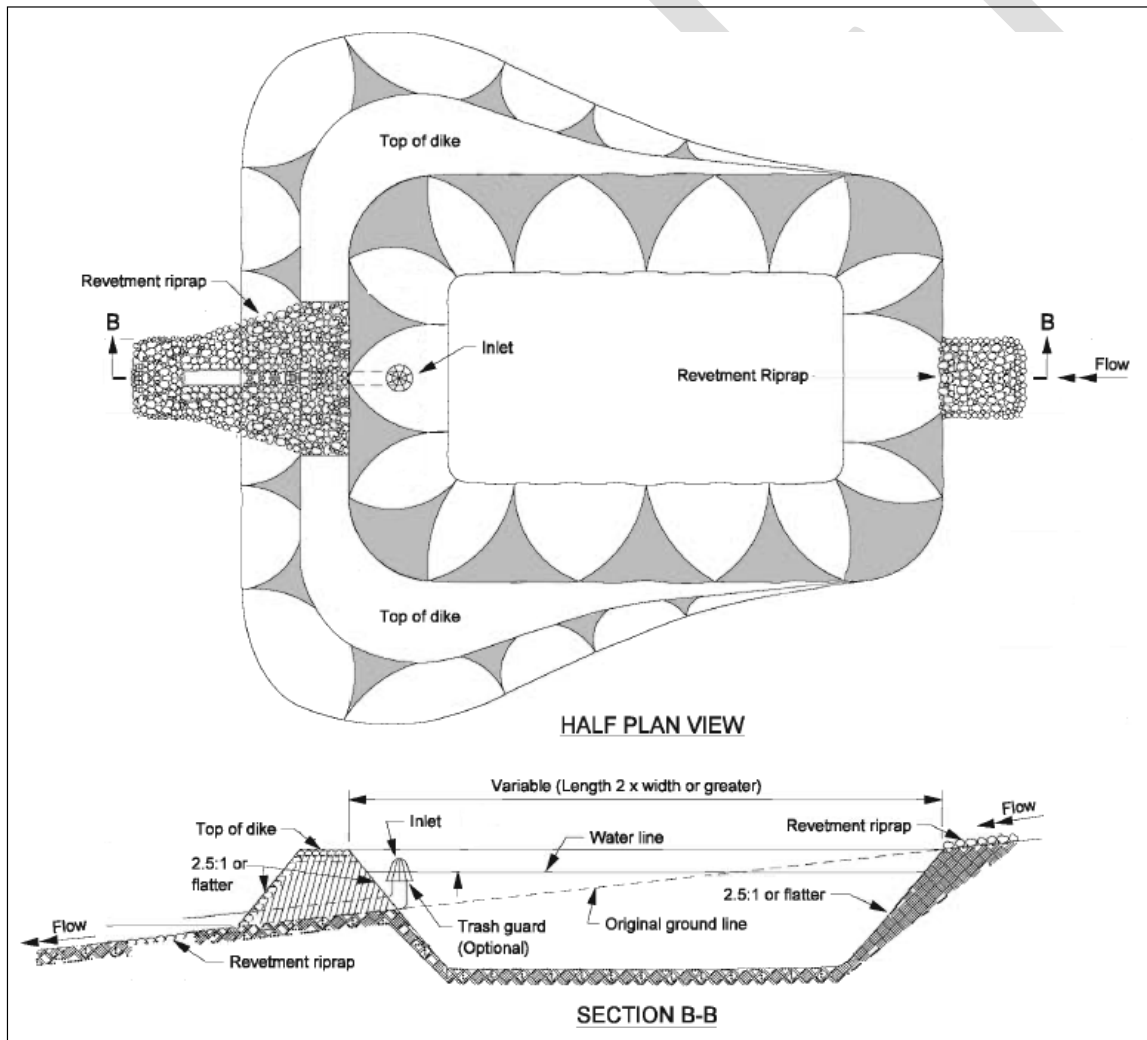

*Figure 11- 1: Example Sediment Basin Layout*

## 11.4 CHANNEL DESIGN CRITERIA

### Minimum Velocity Requirement

All constructed channels shall be designed to facilitate a minimum velocity of 2 ft/sec at design flow to minimize sedimentation and vegetative growth in the channel. Maximum permissible velocities for channel lining must be considered when adhering to this requirement (See Section 11.5).

## 11.5 CULVERT DESIGN CRITERIA

### Minimum Velocity Requirement

All culverts shall be designed to facilitate a minimum velocity of 2.5 ft/sec for partial flow depths. This velocity is specified to minimize sedimentation in the culvert. Maximum permissible outlet velocities and maximum permissible velocities for channel lining must be considered when adhering to this requirement.

The CoEP may require the clogging factors shown in Table 11-1 to be applied to the design crosssection area of culvert openings in high debris/sediment areas where there are no or undersized (per these guidelines) upstream sediment controls.

**Table 11- 1: Clogging Factors**

Culvert Area (ft <sup>2</sup> )	Clogging Factor (%)
0 < x ≤ 4	50
4 < x ≤ 9	40
9 < x ≤ 16	30
6 > x	20

ft<sup>2</sup> = Square feet.

## 11.6 STORM DRAIN SYSTEM DESIGN CRITERIA

### Minimum Velocity Requirement

All storm drain systems shall be designed to facilitate a minimum velocity of 3 ft/sec for the 10-year storm flow. This velocity is specified to minimize sedimentation in the storm drain system. Maximum permissible outlet velocities for channel lining must be considered when adhering to this requirement.

## SECTION 12. FLOODPLAIN MANAGEMENT

---

The purpose of proper floodplain management is to provide measures to protect lives and property. The City of El Paso participates in the National Flood Insurance Program (NFIP) and has adopted a Flood Damage Prevention (FDP) to ensure proper floodplain management development occurs within the identified Special Flood Hazard Areas (SFHA).

The City has taken steps with FEMA to update the current effective FIRMs into digital FIRMs (DFIRMS) with revised floodplains. The City of El Paso has detailed floodplains with base flood elevations (BFEs)



and floodways identified and unnumbered A-zones where no BFEs have been determined. The City has also established a permitting process for any floodplain development that must be adhered to.

## **12.1 FEMA DEFINED FLOODPLAINS AND FLOODWAYS**

FEMA has identified SFHAs and established floodways that are shown on the effective FIRMs. The policies related to implementation of the NFIP Rules and Regulations (Section 60.3) along with those of the City ordinance 18.60 are as follows:

## **12.2 BEST AVAILABLE DATA**

New or updated data for SFHA's are constantly being developed by the city. It is the City's policy, in conformance with the NFIP Rules and Regulations, to use this information for regulatory purposes when there are no identified SFHA's but has the potential to flood, is more restrictive than what is published on the effective FIRMs or is identified as an unnumbered A zone of the effective FIRMS. It will be considered as "Best Available Data" for floodplain management purposes and will be used for all new development. The data should identify floodplain information such as BFEs and floodway delineations for any proposed structure or development. For proposed subdivisions that impact the SFHA's 5 acres or 50 lots in size, whichever is less, the developer is required to submit a Conditional Letter of Map Revision (CLOMR) for the area of concern. This includes providing technical data developed by a Texas registered professional engineer that has established BFEs and floodway delineations prior to issuance of any permits.

## **12.3 CLOMR REQUIREMENT PRIOR TO ISSUANCE OF A GRADING PERMIT**

Any revisions to a floodplain with detailed data and/or encroachments into the designated floodway or flow path (arroyo) must receive approval from the City of El Paso and FEMA by submitting for a CLOMR. The approved CLOMR request must be received before a grading and drainage permit will be issued by City of El Paso. A Letter of Map Revision (LOMR) will then be required once the proposed development has been completed. After grading and improvements are complete LOMR documents must be submitted to FEMA within **45 days**. Approval from FEMA must be obtained prior to occupancy of facilities.

## **12.4 LOMR REQUIREMENT PRIOR TO FINAL DEVELOPMENT APPROVAL**

Any proposed development that has submitted a CLOMR to FEMA for revisions of the FEMA-designated SFHA's and/or floodway must receive a FEMA-approved LOMR before final approval by City of El Paso or municipalities is granted for building permits.

## **12.5 LOCATION OF STRUCTURES**

The developer should locate proposed structures outside of SFHA's when possible. The floodplain administrator shall work with the developer to determine the building placement prior to issuance of any building or grading permits. Relevant factors that will be considered in the development of adequate structure placement are:

1. The danger to life and property due to flooding or erosion damage.

2. The susceptibility of the proposed facility and its contents to flood damage and the effect of such damage on the individual owner.
3. The danger that materials may be swept onto other lands to the injury of others.
4. The compatibility of the proposed use with existing and anticipated development as determined by the director of planning, research, and development.
5. The safety of access to all buildings in the time of flood.
6. The expected heights, velocity, duration, rate of rise, and sediment transport of the floodwaters at the site.
7. The justification of the proximity of the facility to the abutting floodway, where applicable.
8. The availability of alternate locations, not subject to flooding or erosion damage, for the proposed use.
9. The relationship of the proposed use to the comprehensive plan for that area.

## **12.6 PUBLIC AND PRIVATE ROADS AFFECTING EFFECTIVE SFHA'S**

A CLOMR and LOMR must be submitted to the City of El Paso and FEMA for approval for any proposed roadways that affect a designated SFHAs and/or floodway. In the event that a proposed project is located within a SFHA with BFEs established, a Texas licensed professional engineer shall submit, at a minimum, a grading plan, drainage control plan, and temporary and permanent erosion control plans to the City of El Paso.

The grading plan shall include existing contours, proposed contours, finished grade elevations, and finished floor elevations. Detailed information of the grading is presented in the current Grading Regulations. It is unacceptable that the proposed grading scheme adversely impact adjoining properties or existing structures. The drainage control plan shall depict flow patterns and high and low points, and locations of existing and proposed drainage systems. The temporary and permanent erosion control plan shall show location and installation of erosion control elements and will be in accordance with 18.44 of the city ordinance.

## **12.7 FLOODPLAIN MANAGEMENT STANDARDS FOR SFHA'S WITHOUT BFE'S**

For development in areas of the SFHA's without BFE's established, the development must comply with the following:

## **12.8 ANCHORING**

All new construction or substantial improvements shall be designed or modified and adequately anchored to prevent flotation, collapse, or lateral movement of the structure resulting from hydrodynamic and hydrostatic loads, including the effects of buoyancy. As defined in the FDP regulation, new construction is defined as structures for which the start of construction commenced on or after the effective date of the floodplain management regulation adoption by the City of El Paso and includes any subsequent

improvements to such structures. Substantial improvement is defined as any reconstruction, rehabilitation, addition, or other improvement of a structure, the cost of which equals or exceeds fifty percent of the market value of the structure before start of construction of the improvement. *Please refer to the FDP regulation for a complete listing of relevant definitions.*

## **12.9 CONSTRUCTION MATERIALS AND METHODS**

All new construction and substantial improvements shall be constructed:

1. With materials and utility equipment resistant to flood damage.
2. Using methods and practices that minimize flood damage.

## **12.10 UTILITIES**

All new and replacement water supply systems shall be designed to minimize or eliminate infiltration of floodwaters into the system.

1. New and replacement sanitary sewerage systems shall be designed to minimize or eliminate infiltration of floodwaters into the systems and discharge from the systems into floodwaters.
2. On-site waste disposal systems shall be located to avoid impairment to them or contamination from them during flooding.

All new construction or substantial improvements shall be constructed with electrical, heating, plumbing, ventilation and air conditioning equipment, and other service facilities that are designed and/or located to prevent water from entering or accumulating within the components during conditions of flooding.

## **12.11 SUBDIVISION PROPOSALS IN SFHA'S**

Subdivision proposals in SFHA's shall conform to the following:

1. All subdivision proposals shall be consistent with the need to minimize flood damage.
2. All subdivision proposals shall have public or private utilities and facilities such as sewer, gas, electrical, and water systems located and constructed to minimize flood damage.
3. All subdivision proposals shall have adequate drainage provided to reduce exposure to flood damage.
4. Base flood elevation data shall be provided for subdivision proposals and other proposed developments within the SFHA and submitted to FEMA for approval.

## **12.12 STANDARDS OF AREAS OF SHALLOW FLOODING (AO AND AH ZONES)**

These SFHA's have associated base flood depths of one to three feet where a clearly defined channel does not exist and where the path of flooding is unpredictable and indeterminate. Therefore, the following provisions apply: All new construction and substantial improvements of residential structures must have the lowest floor, including the basement, elevated above the highest adjacent grade at least as high as the

depth number specified in feet on the FIRM (at least two feet if no depth number is specified). All new construction and substantial improvements of nonresidential structures must:

1. Have the lowest floor, including the basement, elevated above the highest adjacent grade at least as high as the depth number specified in feet on the County FIRM (at least two feet if no depth is specified); or
2. Be designed together with attendant utilities and sanitary facilities so that the structure is watertight below the base flood level with walls substantially impermeable to the passage of water and with structure components having the capability of resisting hydrostatic and hydrodynamic loads of effects of buoyancy.
3. A Texas licensed professional engineer shall submit a waterproof certification and elevation certificate to the City floodplain administrator that the standards of this section are satisfied.
4. Require adequate drainage paths around structures on slopes within zones AH and AO to guide floodwaters around and away from proposed structures.

### **12.13 FLOODPLAIN MANAGEMENT STANDARDS FOR SFHA’S W/ ESTABLISHED BFE’S**

For development in SFHA’s where BFE’s have been established, the following specifics apply:

#### **12.14 RESIDENTIAL CONSTRUCTION**

New construction and substantial improvements of any residential structure shall have the lowest floor, including the basement, elevated one foot above the BFE. An elevation certificate will be required to document this.

#### **12.15 NONRESIDENTIAL CONSTRUCTION**

New construction and substantial improvement of any commercial, industrial, or other nonresidential structure shall either have the lowest floor, including the basement, elevated one foot above the BFE, or it, together with attendant utility and sanitary facilities shall:

1. Be flood proofed so that the structure is watertight below the base flood level with walls substantially impermeable to the passage of water.
2. Have structural components capable of resisting hydrostatic and hydrodynamic loads and effects of buoyancy.
3. Be certified by a Texas licensed professional engineer that the standards of this subsection are satisfied. In addition, elevation certificate is required for this section.

#### **12.16 MANUFACTURED HOMES**

1. All manufactured homes to be placed within zone A shall be installed using methods and practices which minimize flood damage. For the purpose of this subsection, manufactured homes must be elevated and anchored to resist flotation, collapse, or lateral movement. Methods of anchoring may include, but are not limited to, use of over-the-top or frame ties to ground anchors. This

requirement is in addition to applicable state and local anchoring requirements for resisting wind forces.

2. All manufactured homes are to be placed or substantially improved within zones A1-30 and AH on the community's FIRM. They must be elevated on a permanent foundation such that the lowest floor of the manufactured home is 1-foot above the base flood elevation and must be securely anchored to an adequately anchored foundation system in accordance with the provision of section 12.12.

### **12.17 FLOODWAYS OR ARROYO**

Floodways are an extremely hazardous area due to the velocity of the floodwaters, which carry debris and potential projectiles, along with a significant erosion potential. It must be kept clear of all obstructions to allow the flow of the 100-year storm event; therefore, the following provisions shall apply:

1. Encroachments are prohibited, including fill, new construction, substantial improvements, and other developments, unless a CLOMR has been submitted
2. All new construction and substantial improvements shall comply with all applicable flood hazard reduction provisions of this section.
3. Prohibit placement of any mobile homes

### **12.18 AREAS OUTSIDE THE SFHAS**

There are many flood prone areas in the County of El Paso that do not have identified SFHAs. The city's mission is clear: to provide regional flood hazard identification, regulation, remediation, and education for residents so that they can reduce their risks of injury, death, and property damage from flooding, while still enjoying the natural and beneficial values served by SFHA's.

The city pertaining to areas outside of SFHA's or erosion prone areas are provided in the following:

### **12.19 REQUIREMENT TO DELINEATE 100-YEAR SPECIAL FLOOD HAZARD AREA OR ESTABLISH MINIMUM FINISHED FLOOR ELEVATION**

In locations where development is proposed and a SFHA designation does not exist but has the potential to be a flood prone area, the delineation of the 100-year special flood hazard area may be required. Elevations determined, by a professional engineer, and must comply with FDP ordinance, or they must establish the minimum finished floor elevation to be at 3 feet about the highest adjacent grade to the proposed structure.

### **12.20 EROSION PROTECTION**

Building pads and foundations may be required to have an additional setback or be protected from erosion and scour.

## **12.21 LOT GRADING**

Lots are to be graded to drain so as not to adversely affect adjacent property owners. Runoff redirected from its natural flow location may drain onto or through an adjacent property if a written agreement is in place with the affected property owner or a drainage easement or tract is provided or obtained. Such agreements, easements, or tract must be recorded against the deed of the affected properties. A legal description and exhibit drawing of every easement and/or agreement must be included as a part of the recorded documents.

## **SECTION 13. RIGHTS-OF-WAY AND EASEMENTS**

---

When a subdivision is traversed by a watercourse, drainage way, channel, and underground facilities, there shall be provided either a (public or private) storm water easement or drainage right-of-way conforming substantially to the lines of such a watercourse, and of such width and construction as outlined in this section. When a proposed drainage system routes storm water across private land outside the subdivision, appropriate drainage rights shall be secured by the sub-divider and indicated on the plat. All existing and proposed drainage easements and rights-of-way shall be shown on the plat.

Rights-of-way and permanent easements required for drainage, flood control, and erosion control facilities will conform to the following criteria:

### **13.1 STORM WATER DESIGN**

#### **13.1.1 General Requirements**

The subdivider shall provide for the design of the storm water management in the subdivision and shall design and install all required storm water management facilities. The storm water management of the subdivision shall conform to an existing approved stormwater master drainage plan and drainage facilities shall conform to the stormwater construction details. Required computations shall be prepared by an engineer and submitted with the drainage plans.

#### **13.1.2 Accessibility to public storm sewers**

Public storm sewer systems shall be accessible for inspection and maintenance by the municipality from a public ROW.

#### **13.1.3 Accommodation of downstream drainage areas**

Methods to mitigate adverse downstream drainage conditions created by the development of the subdivision shall be included in the subdivision plans. No adverse downstream drainage impacts will be allowed.

#### **13.1.4 Accommodation of Runoff**

Drainage facilities shall have enough capacity for potential runoff from upstream watershed drainage areas, whether inside or outside the subdivision. The size of the facility shall be based on the provisions of the stormwater construction details, using conditions of maximum potential watershed development, and such calculations shall be subject to the approval of the flood plain administrator.

## **SECTION 14. GREEN INFRASTRUCTURE**

---

### **14.1 BACKGROUND AND PURPOSE**

Development and urbanization alter and inhibit the natural hydrologic processes of surface water infiltration, percolation to groundwater, and evapotranspiration. Prior to development, known as predevelopment conditions, up to half of the annual rainfall infiltrates into the native soils. In contrast, after development known as post-development conditions, developed areas can generate up to four times the amount of annual runoff and one-third the infiltration rate of natural areas. This change in conditions leads to increased erosion, reduced groundwater recharge, degraded water quality, and diminished stream flow.

Traditional engineering approaches to stormwater management typically use concrete detention ponds and channels to rapidly convey runoff from developed surfaces into drainage systems, discharging large volumes of stormwater and pollutants to downstream surface waters. As a result, stormwater runoff from developed land is a significant source of many water quality, stream morphology, and ecological impairments. Sustainable Stormwater Management (SSWM) has emerged as an alternative stormwater management approach that is complementary to conventional stormwater management measures. It is based on many of the natural processes found in the environment to treat stormwater runoff, balancing the need for engineered systems in urban development with natural features and treatment processes. Reducing the overall imperviousness and using the natural drainage features of a site are important design strategies to maintain or enhance the baseline hydrologic functions of a site after development. This can be achieved by applying SSWM practices, which replicate natural hydrologic processes and reduce the disruptive effects of urban development and runoff.

SSWM strategies focus on mimicking predevelopment conditions using native or improved soils, vegetation, and bioengineering applications to reduce and treat the increased flow that development creates. Unlike the conventional method of quickly discharging stormwater offsite and conveying it to a downstream watershed, SSWM treats stormwater as a resource onsite. Site assessment, site planning, and onsite stormwater management guide the initial design phases of a project to maintain a more hydrologically functional landscape even in denser urban settings.

Green Infrastructure (GI) refers to constructed features used in SSWM strategies. GI uses constructed, natural systems to manage stormwater in a manner that promotes capturing, cleaning, and filtering stormwater. Unlike single-purpose gray stormwater infrastructure, which uses pipes and concrete lined channels to convey stormwater, GI uses vegetation and soil to manage rainwater where it falls. Weaving natural processes into the built environment will slow down runoff velocities, reduce erosion, increase infiltration, and reduce pollutants. GI often results in wildlife habitat and generally promotes the overall health of the watershed. This chapter is designed to inform designers, developers, policymakers, citizens, and others in the City of El Paso (CoEP) about the benefits and design criteria for the implementation of SSWM through the use of GI.

### **14.1.1 Philosophy and Definitions**

Stormwater runoff is often viewed as a nuisance in urban developments, a waste product, something to be “gotten rid of.” However, in an arid location, like El Paso, it is actually a valuable resource. When managed thoughtfully and creatively, stormwater runoff can contribute to more attractive, healthy, and sustainable neighborhoods.

The concept of GI is emerging as a highly effective and attractive approach to controlling stormwater pollution and protecting developing watersheds of urbanized communities throughout the country (Natural Resource Defense Council [NRDC], January 2009). GI integrates stormwater management controls into landscaped green spaces. In doing so, it provides many benefits. It slows and reduces runoff down streets, recharges groundwater, irrigates vegetation, removes pollutants from runoff, and reduces localized flooding during storm events. The benefits continue as it helps to create appealing streetscapes, restores natural habitat, buffers urban noise, filters air pollutants, and helps connect neighborhoods, schools, parks, and business districts.

The terms GI and Low Impact Development (LID) are often used interchangeably to define structural and non-structural SSWM techniques. For the purposes of this chapter, GI and LID are analogous, and will most frequently employ the term GI. GI refers to an adaptable term used to describe an array of materials, technologies and practices that use natural systems, or engineered systems that mimic natural processes, to enhance overall environmental quality and provide utility service. GI has been used to refer to anything from trees in an urban setting to planned, engineered infrastructure in a community.

GI techniques tend to generally use soils and vegetation to slow, infiltrate, evapotranspire and/or reduce stormwater runoff. The Environmental Protection Agency (EPA) defines GI similarly and recognizes GI to manage stormwater runoff. Examples of GI include biofiltration basins (i.e., rain gardens), porous pavement, and median swales. These systems are planned, designed, and managed to mimic natural systems.



### **14.1.2 Green Infrastructure Practices Recommended for El Paso**

Since the goal of GI design is sustainability then SSWM design should bring harmony with the natural landscape preserving and restoring vital ecological services that benefit both our communities and nature. With this in mind it is important to consider the ecological services provided by arroyos in the El Paso landscape. They convey stormwater runoff, recharge groundwater, support unique plant communities, create wildlife habitat, and migration corridors. All are vital functions worth trying to mimic in sustainable design approaches.

The design guide, *Green Infrastructure for Southwestern Neighborhoods*, noted the following about arroyos: “As development occurs, washes have often been... relegated to backyards and blocked from view by large walls, where they are used as sites of criminal activity, used as dumping grounds, invaded with weedy/non-native plants.” By intentionally utilizing GI to create attractive, landscaped spaces in public right-of-way (ROW), CoEP has an opportunity to create added community benefits by bringing drainage features into plain site where they can be appreciated as an asset, landscaped for beauty, and not hidden and abused.

The GI concepts presented herein, can mimic some of the native landscape ecological functions on a small (neighborhood) scale focusing on biofiltration basins and park ponds because water and sediment is managed at the surface where it is visible and easy to maintain. Using GI design native vegetation builds soil structure promoting long term infiltration; they mimic natural ecological functions; and they provide supplemental benefits such as wildlife habitat, landscape aesthetics, recreation opportunities, shade, noise and air pollution reduction.

## **14.2 GREEN INFRASTRUCTURE WITHIN THE PUBLIC RIGHT OF WAY**

### **14.2.1 Bioretention Basins**

Bioretention basins are one of the GI techniques most suitable for El Paso streets. They are small scale, distributed retention basins, planted with native vegetation. Hence, the name, “bio- retention.” Conventional retention basins historically used in El Paso consist of large basins located at the downhill end of a development (“end of pipe”). They are typically eyesores, pose safety concerns, and create maintenance headaches. Conversely, bioretention basins are used to distribute stormwater controls uniformly throughout a development, control stormwater runoff near the point of generation rather than at the “end of pipe,” keep individual basins small, manageable, and safe, and use stormwater to help create attractive neighborhood amenities.

Bioretention basins can take several shapes and forms, but they have common elements:

- Shallow basins, typically ranging from 3 to 18 inches deep
- Inlets or some method to deliberately convey water into the basin
- Sediment traps at inlets to catch sediment, leaf litter, or trash

- Loose, friable soils in the basin bottom to promote infiltration
- Deep rooted vegetation to further promote infiltration and provide attractive landscaping

Four bioretention basin variations are included in this section:

- Basins placed in street medians with curb cuts to accept drainage from streets
- Basins placed along street edges with curb cuts to accept drainage from streets
- Shallow bioretention basins located between sidewalks and street curbs, but without curb cuts so they collect runoff from sidewalks but not streets
- Bioretention with below-grade storage chambers to provide additional stormwater storage and infiltration space hidden beneath the basin

#### **14.2.2 Locating Bioretention Basins within Street Right of Ways**

Bioretention basins, and other GI techniques, work best when they are located immediately adjacent to the impervious surfaces that generate the most stormwater runoff – streets, driveways, parking lots, building downspouts, and sidewalks. When used in public street ROW, the typical goal is to distribute GI stormwater controls uniformly along every street, in medians and street edges. Potential locations for bioretention basins along streets are shown in Figures 3-1 through 3-4 in Appendix 3. The figures show a range of options for locating bioretention basins within existing ROW widths and expanded ROWs for residential streets, minor arterial streets, and major arterial streets. Space for bioretention basins must be created within medians and parkways. To do so, designers must consider a range of alternative and expanded ROWs to create the needed greenspace.

Figure 3-1 in Appendix 3 presents a standard 54-foot local residential ROW without GI and an alternative cross section incorporating GI and one-way streets. Figure 3-2 in Appendix 3 presents options for GI within expanded residential ROW widths. Figure 3-3 in Appendix 3 presents options for GI within major and minor arterials. Figure 3-4 in Appendix 3 presents a conceptual layout called Street Edge Alternative (SEA), incorporating one-way residential streets to create space for expanded parkways containing bioretention basins. In the SEA alternative, on-street parking is replaced with narrow temporary parking lanes for delivery vehicles plus off-street parking.

#### **14.2.3 Distribution and Sizing of Bioretention Basins**

Bioretention basins, and GI, work best when basins are uniformly distributed along streets. They also tend to work best when the drainage areas leading to individual basins are small, generally one-half to one-acre drainages. The goal is to catch runoff close to the point of generation before runoff volumes and velocities become large. A typical goal for sizing an individual bioretention basin is to size it to hold the runoff volume from a ½ inch to 1 inch (or greater) rainstorm from the contributing impervious drainage area. This is not an exact requirement, but if the basins are much smaller, they can become overwhelmed in larger storms.

Selecting the location, number, and size of bioretention basins must be done in conjunction with the sizing of park ponds to achieve the needed retention volume for the entire development. Estimated storage volumes for bioretention basins can be calculated from the basic geometry of each basin using the top width, bottom width, basin length, basin depth, and side slope geometries. Basin pool depths are established by the curb cut elevation and the basin bed elevation, as shown in Figure 3-7 in Appendix 3. Storage volumes in basins can decrease significantly if the bed of the basin is not flat, as shown in Figure 3-7 in Appendix 3, and instead is located on an inclined slope. Also note that storage volumes decrease as profile slopes increase due to lengthening side slopes. Estimated storage volumes used in example calculations presented in this chapter were based on flat slopes and should not be considered representative of project-specific conditions. Storage volumes for below-grade storage chambers/infiltration systems will be a function of the specific products used and the configuration in which they are installed. Designers must calculate retention volumes for individual basins and the total retention volume for all GI incorporated into a development based on the geometries and designs selected.

## **14.2.4 Bioretention Basin Design**

### **14.2.4.1.1 Site Inspection and Soil Testing**

The goal of bioretention is to catch stormwater runoff, filter the runoff through mulch, soil, and vegetation, and promote infiltration of water into the underlying soils. Bioretention basins are designed to infiltrate collected water within 24 hours. Thus, soil types and characteristics are important factors to basin performance and a soils investigation should be conducted to document representative conditions throughout the project area. Soil studies can be coordinated with geotechnical investigations that may be conducted for other project needs but must collect added information to support decisions related to stormwater infiltration capacities and horticultural needs.

Soils investigations should document the following in representative locations where GI will be located:

- Soil type and compaction
- Presence of impermeable layers such as caliche or clay layers
- Presence of topsoil and soil organic matter
- Presence of fill or waste materials
- Depth to bedrock and groundwater
- Infiltration/percolation rates

The primary goals of the investigation are to assess the ability of the soils to support stormwater infiltration and support healthy plant growth. Inspections can be conducted via drill rig, test pits, or hand augers, as may be appropriate for the scale of the project. Infiltration/percolation tests should be conducted at representative locations to evaluate potential stormwater infiltration rates. Such tests should be performed at a depth that will represent the bottom elevation of the future bioretention basins, typically 1 to 2 feet below ground surface. Impermeable layers such as caliche or rock should be noted. If they are shallow, it may be possible to rip or remove them to promote deeper stormwater infiltration from bioretention basins.

Soils should be inspected for the presence of topsoil and organic matter (A Horizon Soils) that will help support healthy plant growth vs. the presence of waste, fill material, or rock that may inhibit plant growth.

Professional judgment is required in the interpretation of all soils reports and in the subsequent preparation of bioretention basin designs, as initial soil investigations will likely represent native or undisturbed conditions prior to construction. Native soils are often highly disturbed by construction activities so undisturbed conditions may not represent post-construction conditions. Topsoil is typically removed and remaining subsoil highly compacted by conventional construction methods. Both actions will impact the performance of bioretention basins to promote infiltration and support plant growth. Where native soils can be protected during construction, they should be. Where they cannot be protected, steps will need to be taken during basin construction to restore disturbed soils. Utility conflicts can present challenges for incorporating GI. Existing or planned utility locations should be documented during the planning stage to minimize utility conflicts with bioretention basins. Overall site slopes and geology should also be considered when locating GI features and consideration given to whether infiltrated stormwater may intercept shallow bedrock shelves or confining layers and create potential seeps in unwanted downslope locations.

#### **14.2.4.2 Basin Locations, Shapes, Sections, and Profiles**

##### **“Off-Line” Design**

In the layouts presented in this section, the bioretention basins are constructed in an “off-line” design. That means that basins are located off to the side of the stormwater flow path (the curb and gutter). Water enters the basins through a curb cut. When the basins are full, no more water will enter them until water infiltrates and the water surface drops below the elevation of the curb cut. In this configuration, water does not flow through and out of the basin, so flow velocities through the basin are limited, which helps prevent erosion and mulch wash-out.

##### **Locations and Shapes**

In street ROW, bioretention basins can be in medians or along street edges between curbs and sidewalks. Figure 3-5 in Appendix 3 presents an example plan view and cross sections for a basin located in a street median with curb cuts to accept runoff from the streets. Figure 3-6 in Appendix 3 presents an example plan view and cross section for a basin located on a street edge with a curb cut to accept runoff from the street. The layouts are similar except for the inlet placements and edge dimensions. In street medians, inlets are needed from both sides of the street. On street edges, a single inlet is needed for each basin.

On street edges, if parking is expected next to the basin, a “step out” bench should be incorporated on the street side if it is anticipated that people may step out of a car onto the edge of the basin. Similarly, it is helpful to include a buffer strip along sidewalk edges so that pedestrians do not step off the edge of the sidewalk directly onto a steep side slope. Along street edges, it is helpful to include steppingstones across a basin. If individual basins are long, there is limited room to walk around them, and it is anticipated that

people may walk across the basins to and from cars. Basin shapes can vary to suit the aesthetic design of the landscape plan.

### **Basin Sections and Profiles**

Two approaches are typically used for basin side slopes; see the examples in Figures 2-5 and 2-6. One approach is to maintain vertical or near vertical sidewalls using landscape rocks. This can help maximize storage volumes and create the appearance of a rocky creek bed. The second approach is to use gently sloped, vegetated soil side slopes, at 3H:1V maximum slope. Plants can be incorporated into the basin bottom, side slopes, or elevated planting benches.

A conceptual basin profile is shown in Figure 3-7 in Appendix 3. Key points include the following:

- The elevation of the curb cut sets the water surface elevation in the basin. The distance between the curb cut and the bed of the basin sets the pool depth.
- On sloped streets, it is important to make sure the ground surface, curb, and sidewalk elevations on the downhill side of the basin are above the curb cut elevation so that water does not spill out of the basin over sidewalks or curbs.
- Locating the curb cut on the downhill end of the basin will result in a shallower inlet channel. Locating it on the uphill end of the basin will require a longer inlet channel from the curb cut to the bottom of the basin.

#### **14.2.4.3 Basin Depths**

The depth of the basin is primarily a function of the soil infiltration rate, plus aesthetic and safety considerations. Bioretention basins should be designed so that all water infiltrates or evapotranspiration occurs within 24 hours. This prevents the breeding of mosquitoes and allows the use of a wide range of plants. The basin depth should first be based on the measured soil infiltration/percolation rate. For example, if an infiltration rate of 8 inches per day was calculated from the testing, the maximum pool depth should be limited to 8 inches so that all water will infiltrate in 24 hours. If a higher infiltration rate was measured in sandy soils, greater pool depths can be used. Maximum pool depths are typically limited to about 15 inches for aesthetic and safety concerns. For larger basins located in street medians with limited access, pool depths may be increased up to 18 inches. In a small narrow basin located next to a sidewalk, the basin depth should be limited to 6 to 12 inches.

#### **14.2.4.4 Shallow Bioretention Basins without Curb Cuts**

In narrow spaces between sidewalks and curbs where it is not practical to make the basin large or deep enough to allow curb cuts and collection of water off streets, a shallow basin can be installed without curb cuts. These basins will collect runoff from adjoining sidewalks and water will sheet flow into the garden rather than enter it through a curb cut inlet. An example cross section is shown in Figure 3-7 in Appendix 3. This configuration collects runoff from a limited drainage area but harvests stormwater to irrigate street trees or other landscaping. Both the bed and side slope of the basin should be mulched or covered with decorative river rock as water can cause erosion gullies on the side slopes where it enters the garden.

#### **14.2.4.5 Basin Construction, Erosion and Sediment Control, and Soil Bed Preparation**

Streets, curbs, and sidewalks will typically be constructed prior to bioretention basins and often the area designated for the bioretention features will be disturbed and compacted during construction. To the extent possible, disturbance of bioretention basin locations should be minimized, construction equipment excluded from those areas, and debris, rubble, asphalt, or concrete washout prohibited from those locations. Future bioretention locations can be used for temporary sediment control basins during construction if the locations are subsequently cleaned, soils restored, and basins properly prepared for bioretention. It is best to construct bioretention basins, and all GI features after all adjoining and uphill properties are constructed, site soils stabilized, and erosion and sediment migration eliminated. Eroded soils from un-stabilized properties can quickly destroy a completed bioretention basin by plugging soils and smothering plants and mulch. Stringent erosion and sediment control provisions must be included in GI construction documents.

Bioretention basins should be excavated with a backhoe or excavator operating from outside the footprint of the basin. Equipment such as skid loaders or frontend loaders should be prohibited in areas where basins will be constructed to avoid soil compaction. Soils in the bed of the basin must be kept loose and friable. Any compacted soils should be restored by ripping and tilling soils to a depth of 12 inches or greater, as necessary, to restore compacted soils. Soils compacted during construction of curbs, sidewalks, or inlets must be restored in the same manner. Identify all utility locations before doing so.

Most native plants adapted to the arid El Paso environment may not need a large amount of soil organic matter. However, if the topsoil has been stripped from the site or soils compacted during construction it may be beneficial to till 2 to 3 inches of mature, stable, well-aged compost or similar organic matter into the soil prior to fine grading to restore organic matter and texture to the soil. Consult with a horticulturalist or landscape architect on the soil organic matter and nutrient needs for the plants selected for the basins.

#### **14.2.5 Curb Cuts, Inlets, and Sediment Traps**

Stormwater should be directed to bioretention basins in a controlled manner since flowing water will create erosion gullies on unprotected slopes, even on shallow, gentle slopes. In shallow bioretention basins without curb cuts, water will enter basins from adjoining sidewalks by flowing down side slopes, so all slopes should be mulched with wood or river rock. Curb cuts and inlets are used to convey water into bioretention basins designed to collect water from streets. Inlets to basins should convey water into the basin while preventing erosion at the let-down point. Common approaches are rock chutes, concrete flumes, or stone steps, as shown in Figure 3-8 in Appendix 3. Rock chutes are easiest to install but fill up with sediment over time so require periodic removal, cleaning, and replacement for maintenance. A sediment trap is intended to provide a location for the deposition and easy clean-out of accumulated sediment, trash, or debris preventing materials from plugging garden soils overtime. It also prevents erosion and scour where water enters the basin and helps spread water across the garden bed.

### **14.2.6 Below Grade Storage Systems**

Additional stormwater retention volume can be incorporated beneath bioretention basins using below grade storage and infiltration chambers placed beneath the beds. See Figure 3-9 in Appendix 3 for conceptual plan and profile illustrations of this configuration. Numerous products are available in the marketplace for this purpose including modular block systems, perforated pipes, arch systems, and various chamber systems. Materials range from plastic to galvanized steel to concrete. Given the range of products available, no single design detail is appropriate. The following are general considerations for this type of system.

Designers should work with manufacturers to customize designs for specific project applications. Thought must be given to how water will be directed into the below grade storage chamber. Approaches include infiltration into the chamber through permeable soils, overflow into the chamber through a drop inlet structure, or a combination of both. Approaches will depend on the type of product used. Where inlets are used, include a trash filter to prevent mulch, trash, and large sediment from entering the chamber. The advantage of inlets is that they can rapidly convey water from sudden large storm events. The disadvantage is they may also convey suspended sediment into the chamber, which can lead to plugging. Cleanout risers should be installed in all below grade storage systems at ends or corners of systems to ensure all reaches of the system are accessible.

Permeable, open wall chamber systems require a filter layer to prevent soils from migrating into the chamber, while also allowing water to soak into it. Some design guides specify that such chambers be wrapped with filter fabric for this purpose. Bioretention experience in other parts of the country has found that filter fabric tends to clog with fine sediments. Due to the heavy sedimentation El Paso experiences, filter fabrics should not be used for this purpose. Other systems have been developed using graded gravel layers in lieu of fabric and can be considered. Below grade storage systems have the potential to collect and infiltrate much larger volumes of water in the same area than can be managed in a bioretention basin alone. As a result, consideration must be given to how well and how deep the water will infiltrate based on localized soil types and geology and whether infiltration of large volumes of water in a concentrated location may cause seepage issues nearby. Soil types, confining layers that can cause the lateral migration of infiltrated water, topography, the location of structures, retaining walls, unstable soils, and locations of below grade utility lines that can potentially create water flow conduits should be considered when locating below grade storage and infiltration systems. Landscape plans must consider the location of the below grade storage systems. Planting zones should be created outside the footprint of the storage chamber as the chambers will inhibit deep penetration of plant roots. Deep root penetration is important for plant survival in El Paso's arid climate. If drop inlets are used to convey water from bioretention basins into below grade storage systems, water will flow through the bioretention basin from the curb cut to the drop inlet. High flow velocities can displace wood mulch. In such situations, decorative river rock mulch may be more appropriate in the center of the basin.

### **14.2.7 Design Considerations for Steep Streets**

Curb cuts and inlets are used to convey water into bioretention basins that collect storm water from streets. On steep streets with longitudinal slopes greater than cross slopes, consideration must be given to directing water to curb cuts so that runoff does not bypass the inlets. It is important to assure that stormwater is readily able to enter the basins along the length of the street so that significant runoff does not accumulate at low spots, produce street ponding, or overwhelm downstream intersections and basins. As shown in Figure 3-10 in Appendix 3, options to direct stormwater to inlets on steep streets include depressed inlets with vanes, depressions (valley gutters) across the street, shallow speed bumps across the street and/or trench drains across the street. It is important to remember that streets should be crowned to direct stormwater to the outer edges of the roadway and that curb cuts should be placed every 40 – 50 feet along the curb. As streets get progressively steeper more aggressive approaches must be used to direct stormwater into the bioretention areas. For slopes greater than seven percent (7%), speed bumps and/or trench drains are recommended to ensure stormwater is directed to the bioretention areas and does not bypass the curb cuts/inlets.

Each option presented above has advantages and disadvantages. Depressed inlets are effective on shallower slopes but may be insufficient on steep slopes. Depressions, speed bumps and trench drains may create sediment deposition points, which will need to be cleaned and maintained periodically, but also provide traffic calming effects. In particular, trench drains may be prone to sediment deposition and require frequent maintenance. Care should be given to the type of grate selected to cover trench drains to ensure the safety of bicyclists and pedestrians. Other design considerations for individual bioretention basins on steep streets include the following:

- It is important to make sure the ground surface, curb, and sidewalk elevations on the downhill side of the basin are above the curb cut elevation so that water does not spill out of the basin over sidewalks or curbs (See Figure 3-7 in Appendix 3).
- Locating the curb cut on the downhill end of the basin will result in a shallower inlet channel; locating it on the uphill end of the basin will result in a significantly longer inlet channel from the curb cut to the bottom of the basin since the uphill street elevation will be much higher than the downhill end.
- The basin bottom must be graded flat to maximize the basin bottom footprint and consequently the storage volume in the basin.

The distribution of bioretention basins uniformly along the length of a street upstream of intersections can significantly reduce the amount of stormwater ponding that occurs at intersections and other low-lying areas. By integrating SSWM features into streetscapes, rather than conveying all runoff to the bottom of a hill, flows at important locations, such as intersections, are reduced.



## **14.2.8 Landscaping**

### **14.2.8.1 Mulch**

Two types of mulch are commonly used in bioretention basins, shredded wood mulch and rock mulch. Wood mulch keeps soil cooler, retains moisture, absorbs pollutants, and degrades over time to add organic matter to soil and encourage the growth of beneficial soil microorganisms. It is also less costly than rock mulch. However, it is lightweight and can move around when water fills the basin or be washed away in locations that have high flow velocities. Coarse, shredded hardwood mulch works best where available. Small chips and nuggets float and should be avoided. Rock mulch stays in place better than wood and can withstand higher flow velocities. It is best used for locations that need erosion protection from water flows. It can be used to create decorative creek beds. Conversely, it heats up more than wood mulch, does not retain moisture as well, does not absorb pollutants or contribute organic matter to soil, and is more costly. Both types of mulch need periodic maintenance. Wood mulch is generally touched up on an annual basis and raked out and replaced every few years. Rock mulch can plug with sediment and must be removed, cleaned, and replaced every few years.

### **14.2.8.2 Plants**

Vegetation provides many benefits in stormwater treatment systems. Plant roots improve soil permeability and infiltration rates as roots grow deeper each year. They add organic matter to soil increasing water and nutrient holding capacity, stabilize erodible soils, and encourage the growth of beneficial microorganisms that help break down pollutants in stormwater. Plants also provide shade, reduce urban heat island effects, filter air pollutants, reduce noise, help restore habitat, and provide neighborhood beautification. Native plants are recommended for use in bioretention basins because they are adapted to El Paso's soils and climate, and they provide wildlife habitat in addition to landscape beauty. Many have deep root systems that help survive drought periods without irrigation.

Even though bioretention basins are designed to collect stormwater, they are well drained planting environments that will be dry for most of the year. The water is designed to infiltrate in 24 hours and many locations will have permeable soils that will not hold water for long periods of time. Consequently, plants selected for bioretention basins should be drought tolerant species that can withstand occasional inundation when it rains, rather than wetland or water loving species. Bioretention basins tend to have three different planting zones: the bottom of the basins, side slopes, and top edges or planting benches. When it rains, deepest water levels will be found in the bottom of the basins, while side slopes and edges will dry out quickly. Taller plants that can tolerate occasional inundation are planted on basin bottoms. They can include trees, shrubs, bunch grasses, and some wildflowers. Cacti and desert succulents such as agave and yuccas are typically planted on dry outside edges or planting benches, as can any drought tolerant grass, flower, shrub, or tree. Bunch grasses, wildflowers, and shrubs can be planted on side slopes. Short plants and groundcovers are typically limited to upper slopes and outside edges of gardens. In general, larger plants often tolerate deeper inundation levels than smaller plants.

#### **14.2.9 Related Design Guides and References**

The following GI design guide for the Southwest U.S. complements this material and may be helpful to designers. It also includes color photos of example bioretention basins.

4. “Green Infrastructure for Southwestern Neighborhoods,” Watershed Management Group, Tucson, Arizona, 2010, <http://www.watershedmg.org/green-streets>.

Native Plant References for the El Paso Region include the following:

5. El Paso Water Utilities – Public Service Board Web Site: Conservation/Desert Plant List  
<http://www.epwu.org/conservation/plants.html>  
El Paso Water Utilities 1154 Hawkins Blvd.  
P.O. Box 511  
El Paso, TX 79961-0511  
915.594.5500
6. “Recommended Southwestern Native Plants for the El Paso/Las Cruces Area of the Chihuahuan Desert Region”  
by Wynn Anderson  
Botanical Curator, Centennial Museum, University of Texas at El Paso  
Number 8, 20 March 2006  
<http://www.utep.edu/leb/pdf/recplant.pdf>
7. Lady Bird Johnson Wildflower Center  
The University of Texas at Austin  
<http://www.wildflower.org/>
8. Recommended Species for West Texas  
[http://www.wildflower.org/collections/collection.php?collection=TX\\_west](http://www.wildflower.org/collections/collection.php?collection=TX_west)
9. Drought Resistant Plants for Texas and Beyond  
[http://www.wildflower.org/collections/collection.php?collection=centex\\_drought](http://www.wildflower.org/collections/collection.php?collection=centex_drought)
10. Native Plant Society of New Mexico, El Paso Chapter  
<http://www.npsnm.org/about/chapters/el-paso-texas/>

#### **14.2.10 Additional Green Infrastructure Approaches**

In addition to biofiltration basins, a number of other GI systems can be utilized to achieve SSWM. In 2012, Crabtree and Associates developed a concept for CoEP for runoff infiltration within public ROW of new developments that led to full infiltration of on-site runoff. This concept, known as a rainwater harvesting street, was applied to the Master Plan for Northwest Hills (Crabtree, 2012). An example cross-section showing location and dimensions of subsurface drains and storage for this concept design can be seen in Figure 3-11 in Appendix 3. Design procedures for this concept for use by local developers have yet to be drafted. With this design, there is no requirement for further surface water retention for on-site

generated drainage. However, systems that rely on infiltration through gravel, engineered soil, and underdrains could be prone to plugging from sediment and dust. It is recommended to limit the use of these techniques at present due to the heavy sedimentation and dust storms experienced in the El Paso area.

## **14.3 PARK PONDS**

### **14.3.1 Background**

The CoEP development design requirements include the following:

- Retain runoff from the 24-hour, 1% annual exceedance probability (AEP), or 100-year return period storm.
- On-site retention of 100% of the runoff from the 24-hour, 100-year return period storm for properties zoned as commercial, industrial, or school/higher education; and
- Provide Park facilities based upon the size of the development.

This section provides concept design guidance for retention facilities that can also be credited for meeting the park facilities requirement.

### **14.3.2 Concept Design Criteria**

The purpose of this section is to provide design criteria guidance to encourage simultaneously addressing the separate requirements for provision of stormwater control and park facilities through design of a “park pond.” The basic design criteria of a park pond are:

- Minimum of two cells, with a total retention volume of the 100-year post-development runoff volume, considering credits for retention in GI design elements upstream and required on-site retention at properties zoned as commercial, industrial, or school/higher education.
- Maximum basin depth of four feet from ground surface or top of berm to surface of park area. This criterion facilitates public access and simplifies maintenance.
- Maximum berm height above existing grade of three feet. Use of berms is discouraged in flat terrain. Berms on three sides of the pond will be needed in sloped terrain. Berms on four sides will not be permitted (berms will not extend above ground surface at the extreme upstream extent), and this criterion prevents the berm from being classified as a regulatory dam.
- Maximum steepness of side slopes for basins and berms of four horizontal to one vertical (4H:1V). This criterion also facilitates public access and simplifies maintenance.
- The upstream cell (“inset pond”) will have a maximum depth of 1 foot. This foot of depth does not count in the maximum four feet of basin depth discussed above. This retention cell will retain approximately 10% of the design volume below the grade of the second cell. This area serves as dead storage for sediment accumulation, and to reduce the frequency of inundation of the second cell used as park space. The maximum side slopes for the interface between the first and second cell is 1V:5H.

- Equipment access ramp per EPWU specification.
- Infiltration from the retention pond into the ground will meet the requirements of SWDM Section 9.4.2.1.
- The entire surface area of the park pond facility (including berms, side slopes) can be credited against the park area requirement associated with residential development.

Designers are encouraged to use a facility shape that conforms to park use, for example:

- Use of an amoeba shape (City of Portland, 2010, Appendix C.3) in areas meant to mimic natural topography
- Use of a rectangle/square, where the park pond has a dual use as a sports field. The rough park pond base area dimension (including area for sediment control) required for use as a soccer field by children under age 11 (U-11) is approximately 1.0 acre, and 1.5 acres for use by children under age 13 (U-13), and 2.1 acres for a full-sized field. The typical crowning of a soccer field has a cross-slope of 1% for fields without subsurface drainage, and 0.5% for fields with subsurface drainage. Only the storage volume above the crest of the sports field will be credited towards retention. The height of crowning will not be counted when comparing to the four feet maximum retention basin storage depth criterion.

## SECTION 15. BIBLIOGRAPHY

---

- Albuquerque Metropolitan Arroyo Flood Control Authority (AMAFCA). *Sediment and Erosion Design Guide*, RCE Ref. No. 90-5560, November 1994.
- AMAFCA. Draft Design guide for Trapezoidal Concrete Flood Control Channels, Revised April 1982.
- American Society of Civil Engineers (ASCE). *Pipeline Design for Water and Wastewater*, 1975.
- Chow, Ven Te. *Open Channel Hydraulics*. McGraw-Hill Book Company, Inc., New York, 1959.
- Chow, Ven Te, Maidment, David R., Mays, and Larry W. *Applied Hydrology*. McGraw-Hill Book Company, Inc., New York, 1988.
- Clark, John W., Viessman, Warren, and Hammer, Mark J. *Water Supply and Pollution Control*, Third Edition, Harper & Row, 1977.
- Code of Federal Regulations, Title 44, Volume 1, Sec. 65.10 – Mapping of Areas Protected By Levee Systems, U.S. Government Printing Office via GPO Access, Revised October 2002.
- City of El Paso. City of El Paso, Texas - Title 19: Subdivision Regulations, Draft April 2007.
- Flood Control District of Maricopa County. *Hydraulics Drainage Design Manual for Maricopa County, Arizona*, Phoenix, Arizona, January 2004.
- King, Horace W. and Brater, Ernest F. *Handbook of Hydraulics for the Solution of Hydrostatic and Fluid-Flow Problems*, Fifth Edition, McGraw-Hill Book Company, Inc., New York, 1963.
- Los Angeles County Flood Control District. *Design Manual – Hydraulics*, Los Angeles, California, Revised 1973.
- Merritt, Frederick S. *Standard Handbook for Civil Engineers*, McGraw-Hill Book Company, Inc., New York, 1968.
- Morris, H.M. and Wiggert, James M. *Applied Hydraulics in Engineering*, Second Edition, The Ronald Press Company, 1972.
- Natural Resources Conservation Service Web Soil Survey <<http://websoilsurvey.nrcs.usda.gov/app/>>, Accessed June 1, 2007.
- Petersen, M. *River Engineering*, Prentice Hall, New York, 1986.
- Rouse, H., (ed). *Engineering Hydraulics*, John Wiley and Sons, Inc., New York, 1950.
- Simons, Li and Associates. *Design Guidelines and Criteria for Channels and Hydraulic Structures on Sandy Soil*, prepare for Urban Drainage and Flood Control District and City of Aurora, Colorado, June 1981.
- Simons, Daryl B. and Senturk, Fuat. *Sediment Transport Technology*, Revised edition, Water Resources Publications, Littleton, Colorado, 1992.

- Streeter, Victor L. *Fluid Mechanics*, Fifth Edition, McGraw-Hill Book Company, Inc., New York, 1971.
- Texas Department of Transportation (TXDOT). *Hydraulic Design Manual*, March 2004.
- US Army Corps of Engineers (USACE). *Engineering and Design – Structural Design of Closure Structures for Local Flood Protection Projects*, EM 1110-2-2705, Office of the Chief of Engineers, Washington, D.C., 1994.
- USACE, *Hydraulic Design of Flood Control Channels*, EM 1110-2-1601, Office of the Chief of Engineers, Washington, D.C. 1970.
- US Department of Homeland Security, Federal Emergency Management Agency (FEMA) Region VI, *Flood Frequency Determination – El Paso County and Incorporated Communities, Texas, Disaster Response Recovery Data*, FEMA-1658-DR, March 2007.
- US Department of the Interior, Bureau of Reclamation. *Hydraulic Design of Stilling Basins and Energy Dissipaters*, Fourth Printing, Office of Water Data Coordination, Reston, Virginia, Revised September 1981.
- US Geologic Survey (USGS). *Guidelines for Determining Flood Flow Frequency*, U.S. Government Printing Office, Washington, Revised 1973.
- US Department of Transportation Federal Highway Administration (FHWA). *Hydraulic Design of Energy Dissipaters for Culverts and Channels*, Hydraulic Engineering Circular No. 14, FHWA-NHI-06-086, Washington, DC., July 2006.
- FHWA. *Debris Control Structures Evaluation and Countermeasures*, Hydraulic Engineering Circular No. 9, Third Edition, FHWA-IF-04-016, Washington, DC., September 2005.
- FHWA. *Hydraulic Design of Highway Culverts*, Hydraulic Design Series No. 5, FHWA-NHI-01-020, Washington, D.C., Revised May 2005.
- FHWA. *River Engineering for Highway Encroachments*, Hydraulic Design Series No. 6, FHWA-NHI-01-004, Washington, D.C., December 2001.
- FHWA. *Introduction to Highway Hydraulics*, Hydraulic Design Series No. 4, FHWA-NHI-01-019, Washington, D.C., August 2001.
- FHWA. *Urban Drainage Design Manual*, Second Edition, Hydraulic Engineering Circular No. 22, FHWA-NHI-01-021, Washington, D.C., July 2001.
- FHWA. *Evaluating Scour at Bridges*, Fourth Edition, Hydraulic Engineering Circular No. 18, FHWA-NHI-01-001, Washington, DC., May 2001.
- FHWA. *Bridge Scour and Stream Instability Countermeasures – Experience, Selection, and Design Guidance*, Second Edition, Hydraulic Engineering Circular No. 23, FHWA-NHI-01-003, Washington, D.C., March 2001.
- FHWA. *Stream Stability at Highway Structures*, Third Edition, Hydraulic Engineering Circular No. 20, FHWA-NHI-01-002, Washington, DC., March 2001.

- FHWA. *Highway Stormwater Pump Station Design*, Hydraulic Engineering Circular No. 24, FHWA-NHI-01-007, Washington, DC., February 2001.
- FHWA. *Design of Riprap Revetment*, Hydraulic Engineering Circular No. 11, FHWA-IF-04-016, Washington, DC., March 1989.
- US Department of Agriculture (USDA) Soil Conservation Service (SCS, now the National Resource Conservation Service). *National Engineering Handbook, Section 3 – Sedimentation*, Soil Conservation Service, Washington, D.C., 1983.
- USDA SCS. *National Engineering Handbook, Section 4 – Hydrology, Chapter 15 – Travel Time, Time of Concentration, and Lag*, Soil Conservation Service, Washington, D.C., 1972.
- USDA SCS. *Soil Survey El Paso County, Texas*, Soil Conservation Service Cartographic Division, Washington, D.C., November 1971.
- USDA SCS. *Planning and Design of Open Channels*, Technical Release No. 25, Soil Conservation Service, Washington, D.C., October, 1971.
- Viessman Jr., Warren and Lewis, Gary L. *Introduction to Hydrology*, Fourth Edition, HarperCollins College Publishers, New York, 1996.

# APPENDIX 1



TITLE 19 - SUBDIVISION  
ORDINANCE

STORMWATER DESIGN MANUAL

SUBDIVISION  
IMPROVEMENT PLAN  
PREPARATION  
GUIDELINES



**APPENDIX 1  
SUBDIVISION IMPROVEMENT PLAN  
PREPARATION GUIDELINES**

<u>TITLE</u>	<u>PAGE</u>
PLAN STANDARDS.....	1-1
TITLE SHEET.....	1-2
GRADING PLAN.....	1-3A thru 1-3B
DRAINAGE PLAN.....	1-4A thru 1-4C
DRAINAGE COMPUTATION TABLES.....	1-5
STREET PLAN & PROFILE.....	1-6A thru 1-6B
STORM SEWER PLAN & PROFILE.....	1-7A thru 1-7D
DETAIL SHEET.....	1-8
CONSTRUCTION PHASING PLAN.....	1-9



TITLE 19 - SUBDIVISION  
ORDINANCE

STORMWATER DESIGN MANUAL

Appendix 1

TABLE OF CONTENTS

# PLAN STANDARDS

- A. LETTERS AND NUMBERS SHALL BE VERTICAL OR SLANTED CAPITAL.  
THE MINIMUM SIZE SHALL BE 1/16-INCH - GUIDELINES ARE  
REQUIRED FOR FREEHAND.
- B. REFERENCE CROSS-SECTION SYMBOLS SHALL BE AS SHOWN

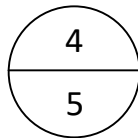

- 1. TOP NUMBER: SECTIONAL DETAIL NUMBER
- 2. BOTTOM NUMBER: SHEET DETAIL NUMBER



TITLE 19 - SUBDIVISION  
ORDINANCE  
STORMWATER DESIGN MANUAL

Appendix 1

PLAN STANDARDS

1-1

## TITLE SHEET

- A. LOCATION PLANS - SCALE ONE (1) INCH = SIX HUNDRED (600) FEET
- B. TITLE SHALL COMPLY WITH THE CITY'S ENGINEERING DEPARTMENT'S STANDARD TITLE SHEET
- C. VICINITY MAP - N. T. S.
- D. INDEX OF DRAWINGS
  - 1. TITLE SHEET
  - 2. FINAL APPROVED PLAT FOR REFERENCE ONLY (IF APPLICABLE)
  - 3. GRADING PLAN
  - 4. DRAINAGE PLAN
  - 5. STREET PLAN & PROFILES
  - 6. CROSS-SECTIONS
  - 7. DETAILS
  - 8. ILLUMINATION PLAN; INCLUDING STREET SIGNAGE & NDCBU LOCATIONS
  - 9. LANDSCAPE & IRRIGATION PLAN
  - 10. STORMWATER POLLUTION PREVENTION PLANS AND ASSOCIATED SPECIFICATIONS
- E. DESIGN FIRM NAME



TITLE 19 - SUBDIVISION  
ORDINANCE

STORMWATER DESIGN MANUAL

Appendix 1

TITLE SHEET

1-2

## GRADING PLAN

- A. NORTH ARROW UP OR LEFT TO RIGHT, A SCALE OF ONE (1) INCH = ONE HUNDRED (100) FEET
- B. GRADING PLAN SHALL BE REFERENCED TO THE PRELIMINARY PLAT VERTICAL CONTROL. VERTICAL CONTROL TO NORTH AMERICAN VERTICAL DATUM (NAVD) 1988.
- C. BOUNDARIES OF SUBDIVISION OR SITE
- D. CONTOUR LINES OF THE PROPOSED SUBDIVISION, AND TWO HUNDRED (200) FEET OUTSIDE AND ABUTTING THE SUBDIVISION UNLESS THE AREA IS MODIFIED BY THE CITY ENGINEER, HAVING THE FOLLOWING INTERVALS:
  - 1. ONE FOOT (1') CONTOUR INTERVALS FOR GROUND SLOPES BETWEEN LEVEL AND THREE (3) PERCENT;
  - 2. TWO FOOT (2') CONTOUR INTERVALS FOR GROUND SLOPES MORE THAN THREE (3) PERCENT AND UP TO AND INCLUSIVE OF ELEVEN (11) PERCENT;
  - 3. FIVE FOOT (5') CONTOUR INTERVALS FOR GROUND SLOPES OVER ELEVEN (11) PERCENT;
  - 4. DASHED LINES FOR EXISTING CONTOUR LINES;
  - 5. SOLID (BOLD) LINES FOR PROPOSED CONTOUR LINES; AND
  - 6. INDEX CONTOURS AT FIVE (5) FEET INTERVALS.
- E. LOCATE ALL EXISTING STRUCTURES WITHIN AND ONE HUNDRED (100) FEET OUTSIDE OF THE SUBDIVISION UNLESS OTHERWISE APPROVED BY THE CITY ENGINEER.
- F. TYPICAL GRADING PLAN FOR LOT SHALL SHOW DIRECTION OF RUNOFF OR ON-SITE PONDING.
- G. FINISHED FLOOR AND FINISHED GROUND ELEVATION FOR ALL LOTS.



TITLE 19 - SUBDIVISION  
ORDINANCE

STORMWATER DESIGN MANUAL

Appendix 1

GRADING PLAN

1-3A

**GRADING PLAN**  
**(continued)**

- H. TOP OF CURB, HEADER CURB AND DRIVEWAY ELEVATIONS.
- I. SLOPE STABILIZATION PLAN, WHERE REQUIRED BY CITY ENGINEER.
- J. EROSION CONTROL PLAN
- K. CONCENTRATED STORM RUNOFF OVER UNPROTECTED AREAS, INCLUDING SLOPES SHALL NOT BE PERMITTED
- L. CROSS SECTIONS AS REQUESTED BY CITY ENGINEER
- M. REQUIRED RETAINING WALLS (LOCATION ONLY, UNLESS TO BE BUILT BY SUBDIVIDER)  
DESIGN OF RETAINING WALLS TWO (2) FEET OR HIGHER SHALL BE SIGNED AND SEALED BY A PROFESSIONAL ENGINEER
- N. PLANS SHALL SHOW FLOOD ZONE AREAS AS PER CURRENT FLOOD INSURANCE RATE MAPS (FIRM) OR LETTER OF MAP REVISION (IF APPLICABLE), REFERENCE PANEL NUMBER AND DATE
- O. FINISHED FLOOR ELEVATIONS SHALL COMPLY WITH DRIVEWAY ORDINANCE AND/OR FEMA REGULATIONS.



TITLE 19 - SUBDIVISION  
ORDINANCE

STORMWATER DESIGN MANUAL

Appendix 1

**GRADING PLAN**

**1-3B**

## **DRAINAGE PLAN**

(REFER TO STORMWATER DESIGN MANUAL FOR DRAINAGE CRITERIA,  
DESIGN METHODS AND METHODOLOGIES)

- A. SCALE ONE (1) INCH = ONE HUNDRED (100) FEET - NORTH ARROW
- B. DRAINAGE PLANS SHALL CONFORM TO THE APPROVED MASTER DRAINAGE PLAN, IF APPLICABLE
- C. SHOW BOUNDARIES OF SUBDIVISION AND CONTRIBUTING DRAINAGE AREAS
- D. IDENTIFY LIMITS OF CONTRIBUTING WATERSHED AREAS WITHIN SUBDIVISION AND OUTSIDE THE SUBDIVISION
- E. CALCULATION TABLE TO INCLUDE TIMES OF CONCENTRATION ( $T_c$ ), INTENSITIES (I), COEFFICIENT VALUES (C) AND EXPECTED RUNOFFS OF ALL WATERSHED AREAS - EXPECTED RUNOFF QUANTITIES, CARRYING CAPACITIES, AND RUNOFF VELOCITIES FOR DRAINAGE STRUCTURES SHALL BE SHOWN ON PLANS FOR 25, 50 AND 100 YEAR EVENTS.
- F. SHOW LOCATION AND SIZES OF ALL PROPOSED AND EXISTING DROP INLETS, PIPES, CULVERTS, CHANNELS, BASINS, AND OTHER DRAINAGE STRUCTURES
- G. SHOW EXISTING AND PROPOSED DRAINAGE FLOW PATTERNS
- H. SHOW HIGH AND LOW POINTS OF STREET WITH FLOW PATTERNS



TITLE 19 - SUBDIVISION  
ORDINANCE

STORMWATER DESIGN MANUAL

Appendix 1

**DRAINAGE PLAN**

**1-4A**

**DRAINAGE PLAN**  
(continued)

I. STORAGE FACILITIES (DAMS, PONDS, ETC.) INDICATING:

1. MAXIMUM CAPACITY
2. EXPECTED RUNOFF
3. BOTTOM ELEVATION
4. HIGH WATER SURFACE
5. FREE BOARD
6. SPILLWAY AND OUTLET STRUCTURE
  - (A) MAXIMUM CAPACITY
  - (B) DESIGN OUTFLOWS
7. SEDIMENT AND EMERGENCY VOLUMES
8. APPROVAL FROM TEXAS WATER BOARD AND U.S. ARMY CORPS OF ENGINEERS FOR DAMS, WHEN APPLICABLE
9. SOIL TESTS TO DETERMINE SPECIAL STABILIZED SLOPES
10. PERCOLATION RATE TESTS TO BE PERFORMED AT PROPOSED POND INVERT (RETENTION BASINS ONLY). TO BE PERFORMED WHEN THE WATER TABLE (ELEVATION) IS AT IT'S HIGHEST.
11. EXISTING WATER TABLE ELEVATION DURING OFF-PEAK PERIOD AND HIGH WATER TABLE ELEVATION, IF APPLICABLE.



TITLE 19 - SUBDIVISION  
ORDINANCE

STORMWATER DESIGN MANUAL

Appendix 1

**DRAINAGE PLAN**

**1-4B**

**DRAINAGE PLAN**  
(continued)

- J. ON LOTS WITH ON-SITE PONDING THE FOLLOWING INFORMATION SHALL BE SUBMITTED
1. PRELIMINARY SOILS TEST. FINAL PERCOLATION RATE TEST, SOILS TESTS, AND WATER TABLE ELEVATION INFORMATION TO BE SUBMITTED PRIOR TO STREET ACCEPTANCE AND/OR BUILDING PERMITS. PERCOLATION TESTS TO BE PERFORMED AT THE INVERT WHERE STORMWATER WILL BE RETAINED AND WHEN THE WATER TABLE IS AT ITS HIGHEST.
  2. TYPICAL LOT CROSS SECTION DETAIL SHOWING ON-SITE PONDING STORAGE CAPACITY
  3. PERMANENT ELEVATION MARKER DETAIL (REFER TO PAGE 2-3)
  4. DRAINAGE COMPUTATIONS BASED ON 100-YEAR STORM
  5. MINIMUM OF 2.0% CROSS SLOPE ON STREET
  6. LOTS AND/OR MEDIANS SHALL ALSO ACCOMMODATE ALL STREET RUNOFF
  7. FIFTY (50) PERCENT OF THE RESIDENTIAL LOT AREA SHALL REMAIN WITHOUT STRUCTURES OR OTHER IMPERMEABLE SURFACES
  8. ADDITIONAL EMERGENCY AND SILT/DEBRIS CAPACITY NOT REQUIRED FOR RESIDENTIAL ON-SITE PONDING LOTS
- K. STREET DESIGN REQUIREMENTS
1. GENERAL STANDARDS
    - (A) MAXIMUM STANDARD CURB HEIGHT - 6 INCHES UNLESS OTHERWISE APPROVED BY THE CITY ENGINEER
    - (B) CROWN ON STREET TO BE FROM ZERO (0) TO THREE (3) PERCENT SLOPE
    - (C) INVERT STREET CROSS SECTION ALLOWED WITH VALLEY GUTTER
    - (D) NO PONDING (UNDRAINED LOW POINTS) TO BE ALLOWED ON STREETS TO PREVENT PAVEMENT DETERIORATION



TITLE 19 - SUBDIVISION  
ORDINANCE  
  
STORMWATER DESIGN MANUAL

Appendix 1

**DRAINAGE PLAN**  
**1-4C**



## DRAINAGE COMPUTATION TABLES

DETENTION OR RETENTION BASINS							
BASIN NO.	REQUIRED CAPACITY (AC.FT)	AVAILABLE CAPACITY (AC.FT)	PEAK INFLOW (CFS)	OUTLET TOWER FLOW (CFS)	HIGH WATER SURFACE ELEVATION (FT)	BOTTOM ELEVATION	FREE BOARD (FT)

WATERSHED AREAS					
DRAINAGE AREA NO.	DRAINAGE AREA (AC)	DESIGN STORM INTENSITY	TIME OF CONCENTRATION	RUNOFF COEFF. (C)	Q (CFS)

DROP INLETS			
DROP INLET NO	REQ. FLOW CAPACITY Q REQ (CFS)	AVAIL. FLOW CAPACITY Q AVAIL.(CFS)	FLOW BYPASS



TITLE 19 - SUBDIVISION  
ORDINANCE

STORMWATER DESIGN MANUAL

Appendix 1

DRAINAGE  
COMPUTATION  
TABLES

1-5

## STREET PLAN AND PROFILE

### A. PLAN

1. STREET NAMES
2. VERTICAL CONTROL TO NORTH AMERICAN VERTICAL DATUM (NAVD) 1988 AND SHOWN ON EVERY SHEET
3. SCALE ONE (1) INCH = THIRTY (30) FEET MAXIMUM HORIZONTAL VERTICAL SCALE OF ONE (1) INCH = FIVE (5) FEET FOR SLOPES OF ZERO (0) PERCENT TO THREE (3) PERCENT AND ONE (1) INCH = TEN (10) FEET FOR SLOPES GREATER THAN THREE (3) PERCENT
4. EXISTING STRUCTURES AND TOPOGRAPHIC FEATURES
5. SURVEY CONTROL LINE
6. RIGHT-OF-WAY LINES, CURB LINES AND CENTERLINES
7. RIGHT-OF-WAY AND ROADWAY WIDTHS
8. CURB RETURN DATA
9. CENTERLINES AND CURB DATA
10. STATIONING ALONG CENTERLINE
11. STATION AT SPECIAL POINTS (PC, PT, PRC, CB, RET, CL INTERSECTIONS, LC, ETC.)
12. TOP OF CURB ELEVATION AT SPECIAL POINTS (PC, PT, PRC, CB, RET)
13. PROPOSED AND EXISTING DRAINAGE STRUCTURES
14. DIRECTION OF FLOW AND HIGH AND LOW POINTS
15. FIFTY (50) FOOT (MINIMUM) TRANSITIONS FROM CROWN - FLAT - INVERT
16. LIMITS OF CONSTRUCTION
17. LOCATION OF GUARDRAIL AND DEAD END SIGNS
18. MATCH STATIONS FOR FOLLOWING PAGE
19. SHOW ALL EXISTING STRUCTURES AND IMPROVEMENTS ONE HUNDRED (100) FEET PAST THE LIMITS OF CONSTRUCTION UNLESS OTHERWISE APPROVED BY THE CITY ENGINEER
20. SIDEWALK LOCATIONS



TITLE 19 - SUBDIVISION  
ORDINANCE  
STORMWATER DESIGN MANUAL

Appendix 1

STREET PLAN  
AND PROFILE

1-6A

**STREET PLAN AND PROFILE**  
(continued)

**B. PROFILE**

1. EXISTING AND PROPOSED PROFILES AT CURB LINES
2. PROPOSED PERCENT GRADE FOR ALL PROFILES
3. MINIMUM OF FIVE TENTHS (0.5) PERCENT GRADE AND A MAXIMUM OF ELEVEN (11) PERCENT GRADE; EXCEPT THAT UP TO FIFTEEN (15) PERCENT GRADE IN THE MOUNTAIN DEVELOPMENT AREA MAY BE PERMITTED WITH APPROVAL OF FIRE DEPARTMENT AND CITY ENGINEER
4. VERTICAL CURVE INFORMATION. THE ENTIRE LENGTH OF VERTICAL CURVE SHALL BE SHOWN ON SAME SHEET
5. EXISTING AND PROPOSED ELEVATIONS AT EVERY FIFTY (50) FEET AND SPECIAL STATIONS
6. STREET PROFILE SHALL EXTEND ONE HUNDRED (100) FEET BEYOND LIMITS OF CONSTRUCTION UNLESS OTHERWISE APPROVED BY THE CITY ENGINEER
7. EXISTING AND PROPOSED DRAINAGE STRUCTURES AS THEY RELATE TO PROFILES
8. PROPOSED STREET PROFILE SHALL MATCH EXISTING STREET PROFILE FOR A SMOOTH TRANSITION
9. OPPOSITE CURB ELEVATIONS SHALL MATCH AT EACH STATION, EXCEPT IN A SUPERELEVATED ROADWAY OR AS APPROVED BY CITY ENGINEER
10. STREET CROWN SHALL NOT EXCEED THREE (3) PERCENT



TITLE 19 - SUBDIVISION  
ORDINANCE

STORMWATER DESIGN MANUAL

Appendix 1

**STREET PLAN  
AND PROFILE**

**1-6B**

## STORM SEWER PLAN AND PROFILE

### A. STORM SEWER PLAN

1. PROPOSED RIGHT-OF-WAY LINE AND WIDTHS
2. LIMITS OF CONSTRUCTION AND MATCH-LINE STATIONING
3. NORTH ARROW AND SCALE
4. NAME OF STREET
5. SURVEY CONTROL LINE
6. STORM SEWER ALIGNMENT TIED TO SURVEY CONTROL LINE
7. BEARINGS (DIRECTION AND HORIZONTAL CURVE DATA)
8. STATIONING
9. SIZE, TYPE, AND CLASSIFICATION OF PIPE
10. MANHOLES - JUNCTION BOXES (CAST-IN-PLACE OR PRE-CAST)
  - (A) STATIONING AND A MAXIMUM OF FIVE HUNDRED (500) FEET ON CENTER - MANHOLE REQUIRED AT CHANGE OF DIRECTION
  - (B) TOP OF COVER ELEVATION
  - (C) INVERT ELEVATION
  - (D) TYPE, SIZE, AND NUMBER OF MANHOLE



TITLE 19 - SUBDIVISION  
ORDINANCE  
STORMWATER DESIGN MANUAL

Appendix 1

STORMSEWER  
PLAN AND  
PROFILE

1-7A

**STORM SEWER PLAN AND PROFILE**  
(continued)

11. DROP INLETS

(A) STATIONING

(B) TOP OF GRATE AND TOP OF CURB/NOSE AT GRATE ELEVATION

(C) INVERT ELEVATION

(D) TYPE, NUMBER OF GRATES, AND DROP INLET NUMBER (TWO (2) GRATE MINIMUM)

(E) STORMWATER DISCHARGE - EXPECTED AND CAPACITY

12. DROP INLET PIPE (LATERALS)

(A) SIZE AND TYPE OF PIPE

(B) TYPE OF CONNECTOR

(C) STORMWATER DISCHARGE - EXPECTED, CAPACITY, AND VELOCITY(IES)

13. SHOW EXISTING DRAINAGE STRUCTURES IN DASHED LINE AND INDICATE SIZE AND TYPE OF STRUCTURE

B. STORM SEWER PROFILE

1. STATIONING ALONG CENTERLINE OF STREET AT EVERY 100 FEET

2. TYPE AND SIZE OF EXISTING DRAINAGE STRUCTURES

3. EXISTING GROUND PROFILE AND PROPOSED TOP OF PAVEMENT

4. PROPOSED STORM SEWER PROFILE WITH PERCENT SLOPE

5. TYPE AND SIZE OF PIPE

6. HYDRAULIC GRADIENT LINE PROFILE WITH ELEVATION SHOWN AT EVERY MANHOLE AND/OR DROP INLETS



TITLE 19 - SUBDIVISION  
ORDINANCE

STORMWATER DESIGN MANUAL

Appendix 1

STORMSEWER  
PLAN AND PROFILE

1-7B

**STORM SEWER PLAN AND PROFILE**  
(continued)

7. MANHOLE
  - (A) SIZE, TYPE, AND MANHOLE NUMBER
  - (B) TOP INVERT ELEVATION
  - (C) CENTERLINE STATIONING
  - (D) INVERT OF CONNECTOR LATERAL - SIZE AND TYPE OF PIPE
  
8. DROP INLETS
  - (A) TYPE, NUMBER OF GRATES AND DROP INLET NUMBER (TWO (2) GRATE MINIMUM)
  - (B) TOP OF GRATE AND INVERT ELEVATIONS
  - (C) CENTERLINE STATIONING
  - (D) STORMWATER DISCHARGE - EXPECTED AND CAPACITY
  
9. CONNECTOR PIPES (INLETS LATERALS)
  - (A) TYPE AND SIZE OF PIPE
  - (B) INVERT AT MAIN STORM SEWER
  - (C) CENTERLINE STATIONING
  - (D) STORMWATER DISCHARGE - EXPECTED, CAPACITY, AND VELOCITY(IES)



TITLE 19 - SUBDIVISION  
ORDINANCE  
  
STORMWATER DESIGN MANUAL

Appendix 1

**STORM SEWER  
PLAN AND  
PROFILE**

**1-7C**

## STORM SEWER PLAN AND PROFILE

(continued)

### 10. EXISTING SANITARY SEWER

#### (A) SANITARY SEWER LINE

- (i.) PROFILE OF SANITARY SEWER
- (ii.) TOP MANHOLE AND INVERT ELEVATIONS
- (iii.) TYPE AND SIZE OF PIPE
- (iv.) PERCENT GRADE
- (v.) DETAIL INFORMATION OF SANITARY SEWER CONFLICTS



TITLE 19 - SUBDIVISION  
ORDINANCE

STORMWATER DESIGN MANUAL

Appendix 1

STORM SEWER  
PLAN AND  
PROFILE  
1-7D

## DETAIL SHEET

WHERE APPLICABLE, THE FOLLOWING SHALL BE PROVIDED:

- A. DROP INLET(S)
- B. MANHOLE(S) AND JUNCTION BOX(ES)
- C. SURVEY MONUMENTS
- D. STORM SEWER TRENCH CROSS-SECTION
- E. PIPE CONCRETE COLLAR(S)
- F. ROCKWALL FENCING
- G. GUARD RAIL(S), BARRICADE(S), AND SIGNAGE
- H. BOX CULVERTS
- I. RETAINING WALL(S) (LOCATION ONLY, UNLESS TO BE BUILT BY SUBDIVIDER)
- J. FOOTING(S)
- K. CHANNEL CONCRETE LINING(S) - CROSS SECTIONS
- L. SPILLWAYS
- M. SEWER PIPE(S) - THRUST BLOCK(S)
- N. SEEPAGE LINE(S) DETAILS
- O. STORM SEWER OUTLET STRUCTURE(S)
- P. BASIN(S) PLAN AND CROSS SECTIONS
- Q. CONFLICTS WITH EXISTING IRRIGATION FACILITIES OR UTILITIES



TITLE 19 - SUBDIVISION  
ORDINANCE

STORMWATER DESIGN MANUAL

Appendix 1

DETAIL SHEET

1-8



## CONSTRUCTION PHASING PLAN

WHERE APPLICABLE:

- A. SHOW ENTIRE LIMITS OF PROJECT
- B. INDICATE LIMITS OF INDIVIDUAL CONSTRUCTION PHASE BY STATIONS
- C. TEMPORARY DRAINAGE PHASING PLAN



TITLE 19 - SUBDIVISION  
ORDINANCE  
STORMWATER DESIGN MANUAL

Appendix 1

CONSTRUCTION  
PHASING PLAN

1-9

# APPENDIX 2



TITLE 19 - SUBDIVISION  
ORDINANCE

STORMWATER DESIGN MANUAL  
CONSTRUCTION DETAILS

**APPENDIX 2  
DRAINAGE AND DRAINAGE STRUCTURES**

<u>TITLE</u>	<u>PAGE</u>
RETENTION BASIN DESIGN (DRAWING) .....	2-1
DETENTION BASIN (DRAWING) .....	2-2
PERMANENT ELEVATION MARKER (FOR ON-SITE PONDING) .....	2-3
POND DEPTH GAUGE .....	2-4
MANHOLE RING .....	2-5
MANHOLE COVER .....	2-6
GRATED MANHOLE COVER .....	2-7
PENETRATION APRON .....	2-8
48" DIAMETER STANDARD CONICAL MANHOLE .....	2-9
48" DIAMETER PRE-CAST MANHOLE .....	2-10
48" DIAMETER CAST-IN-PLACE MANHOLE .....	2-11
72" DIAMETER PRE-CAST MANHOLE .....	2-12
72" JUNCTION BOX .....	2-13
PRECAST CONCRETE MANHOLE COVER FOR 72" MANHOLE .....	2-14
CONCRETE PIPE COLLAR .....	2-15
CONNECTION AT PRE-CAST JUNCTION BOXES .....	2-16
OR EXISTING MANHOLES	
PLASTIC PIPE CONNECTION TO STORMWATER MANHOLE .....	2-17
WATERTIGHT SEAL	
PRE-FABRICATED REINFORCED CONCRETE PIPE WYE .....	2-18
GRATE AND FRAME FOR DROP INLET .....	2-19
DROP INLET TYPE I .....	2-20
DROP INLET TYPE II .....	2-21
DROP INLET TYPE III .....	2-22
OFF-STREET STORM INLET DETAIL .....	2-23



**APPENDIX 2**  
**DRAINAGE AND DRAINAGE STRUCTURES**  
(continued)

<b>TITLE</b>	<b>PAGE</b>
CONCRETE CAP (UNPAVED CONDITION) .....	2-24
CONCRETE CAP (PAVED CONDITION) CONCRETE .....	2-25
CHANNEL TYPE I .....	2-26
CONCRETE CHANNEL TYPE I END WALL DETAIL .....	2-27
CHANNEL LINING AT PIPE DISCHARGE .....	2-28
CONCRETE JOINTS .....	2-29
WATERSTOP DETAIL .....	2-30
DEBRIS TRAP/SAFETY GRATE .....	2-31
NO TRESPASSING WARNING SIGN .....	2-32
CURB OPENING FOR DRAINAGE .....	2-33
ROCKWALL DESIGN .....	2-34
WROUGHT IRON FENCE AND GATE DETAIL .....	2-35
WROUGHT IRON FENCE AND GATE DETAIL .....	2-36
WROUGHT IRON FENCE AND GATE DETAIL .....	2-37
WROUGHT IRON FENCE AND GATE DETAIL .....	2-38
CONCRETE SLOPE PROTECTION MORTAR .....	2-39
FILLED ROCK RIP RAP .....	2-40
GABION MATTRESS RIP RAP .....	2-41



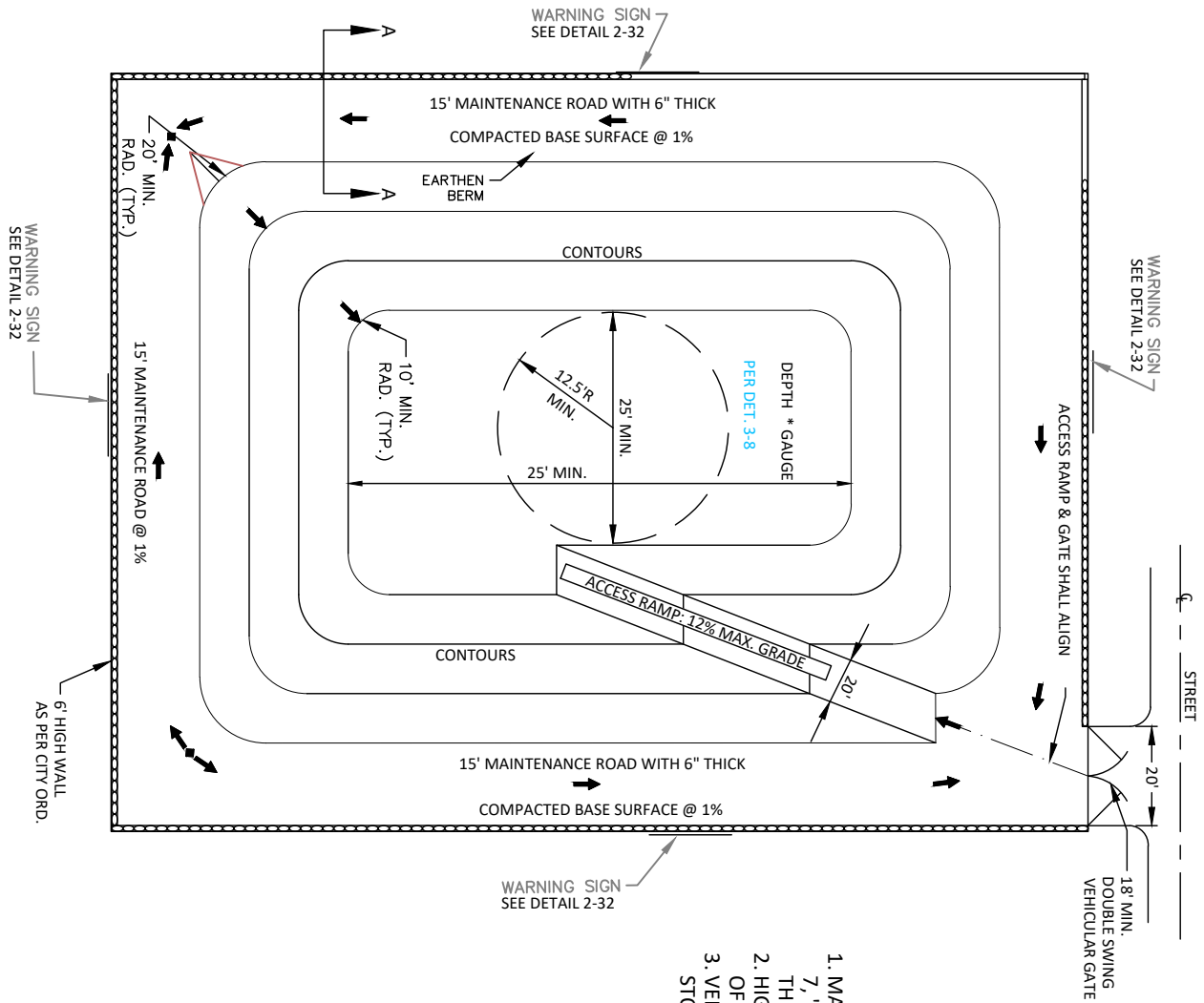

- GENERAL NOTES:**
1. MAXIMUM DESIGN WATER DEPTH IS 20 FEET, REFER TO ITEM 7, "RETENTION BASIN DESIGN REQUIREMENTS" DETAIL X-X OF THE STORMWATER DESIGN MANUAL.
  2. HIGH WALL ADJACENT TO RESIDENTIAL, REFER TO DET. 2-34 OF STORMWATER DESIGN MANUAL.
  3. VEHICULAR GATE REFER TO DET. 2-35 THRU 2-38 STORMWATER DESIGN MANUAL

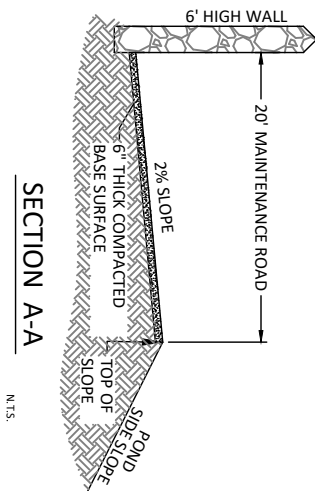

N.T.S.



TITLE 19 - SUBDIVISION  
ORDINANCE  
STORMWATER DESIGN MANUAL  
CONSTRUCTION DETAILS

Appendix 2

RETENTION BASIN  
DESIGN (DRAWING)

2-1

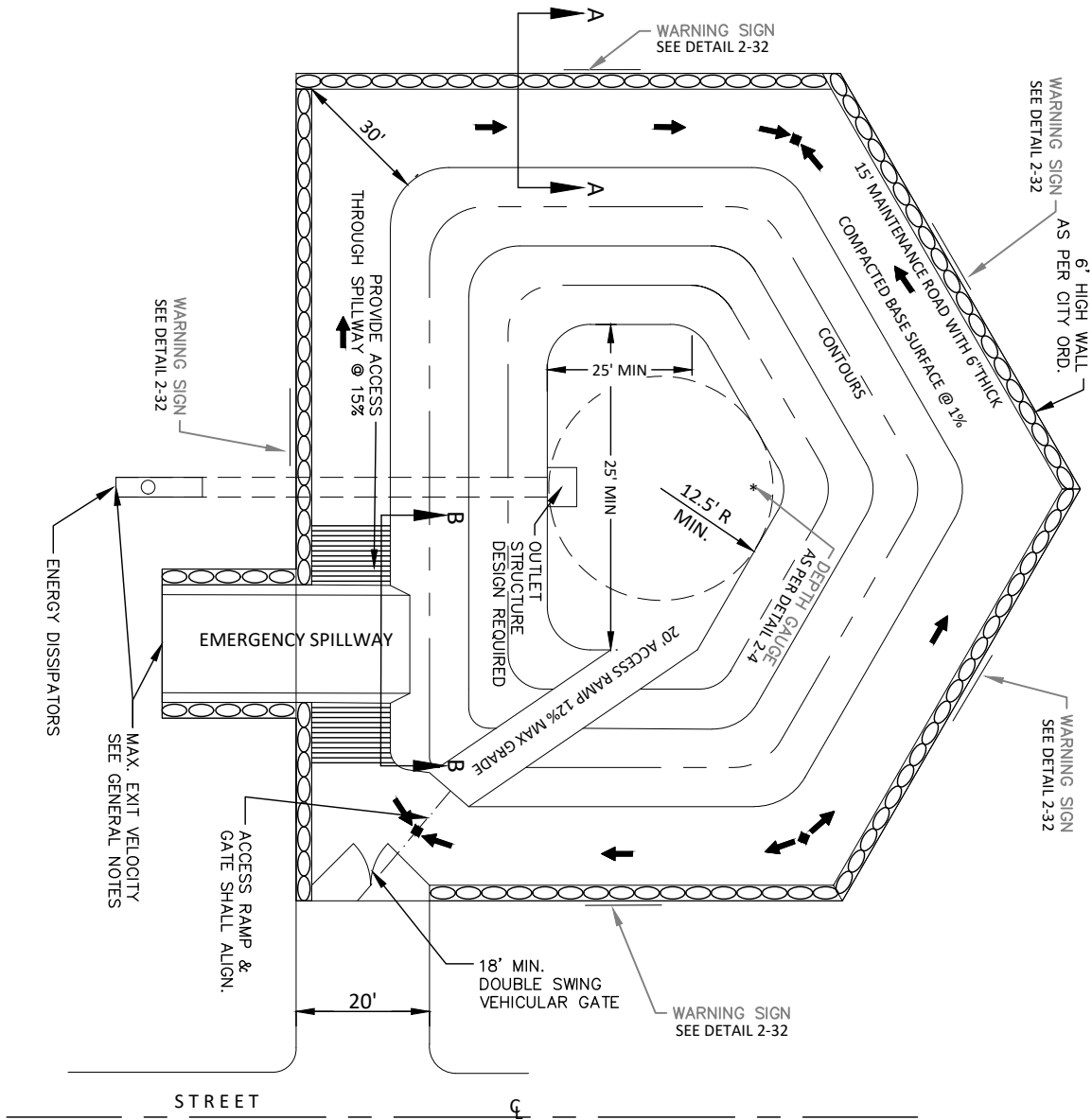

- GENERAL NOTES:**
1. MAXIMUM DESIGN WATER DEPTH IS 20', REFER TO STORMWATER DESIGN MANUAL. MAX. VELOCITY @ DISCHARGE POINTS 6 fps FOR UNPROTECTED GROUND

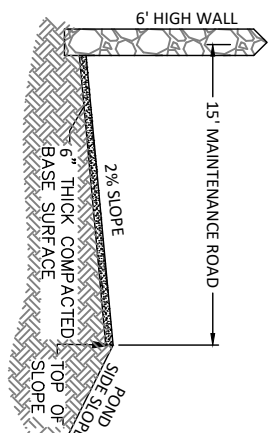
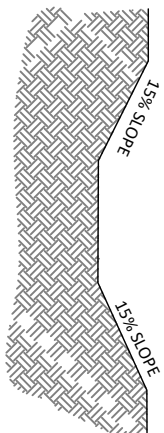

# DETENTION BASIN DESIGN (DRAWING)

TITLE 19 - SUBDIVISION ORDINANCE

STORMWATER DESIGN MANUAL

CONSTRUCTION DETAILS



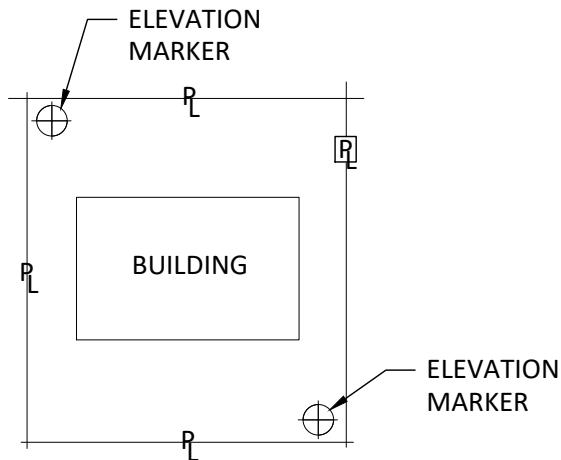
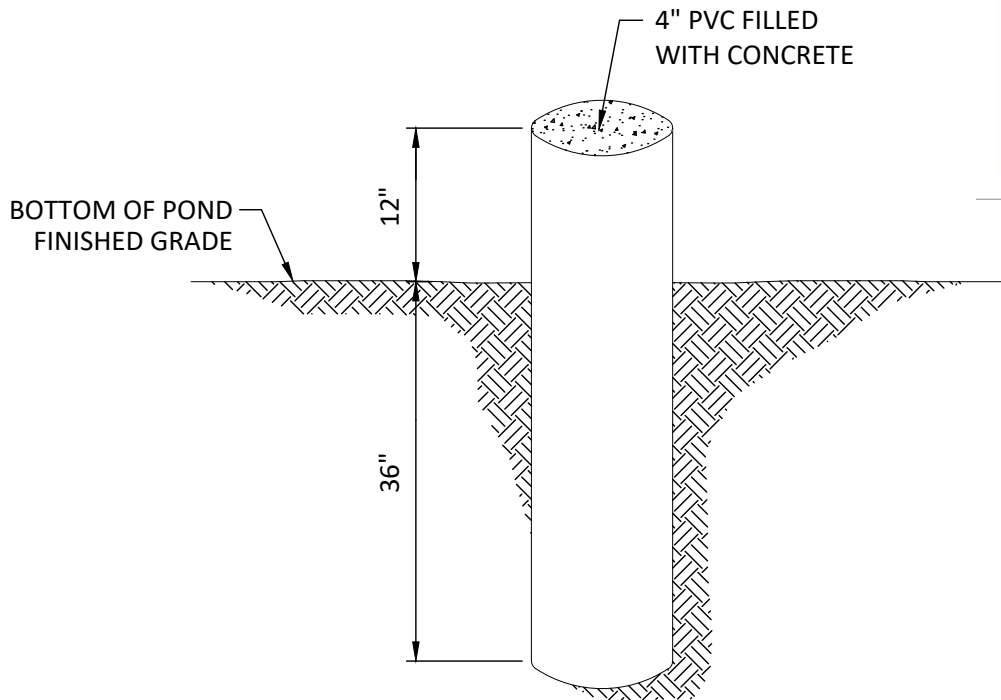

- GENERAL NOTES:**
1. MARKERS TO BE PLACED AT CORNER OF FRONT AND BACK YARDS
  2. SURVEY MARKER TO BE INCLUDED PER EACH ON-SITE PONDING MARKER.



TITLE 19 - SUBDIVISION  
ORDINANCE

STORMWATER DESIGN MANUAL  
CONSTRUCTION DETAILS

PERMANENT  
ELEVATION MARKER  
FOR ON-SITE PONDING

GENERAL NOTES:

1. ALTERNATES WILL BE ALLOWED WITH THE PRIOR REVIEW AND APPROVAL OF THE CITY ENGINEER.

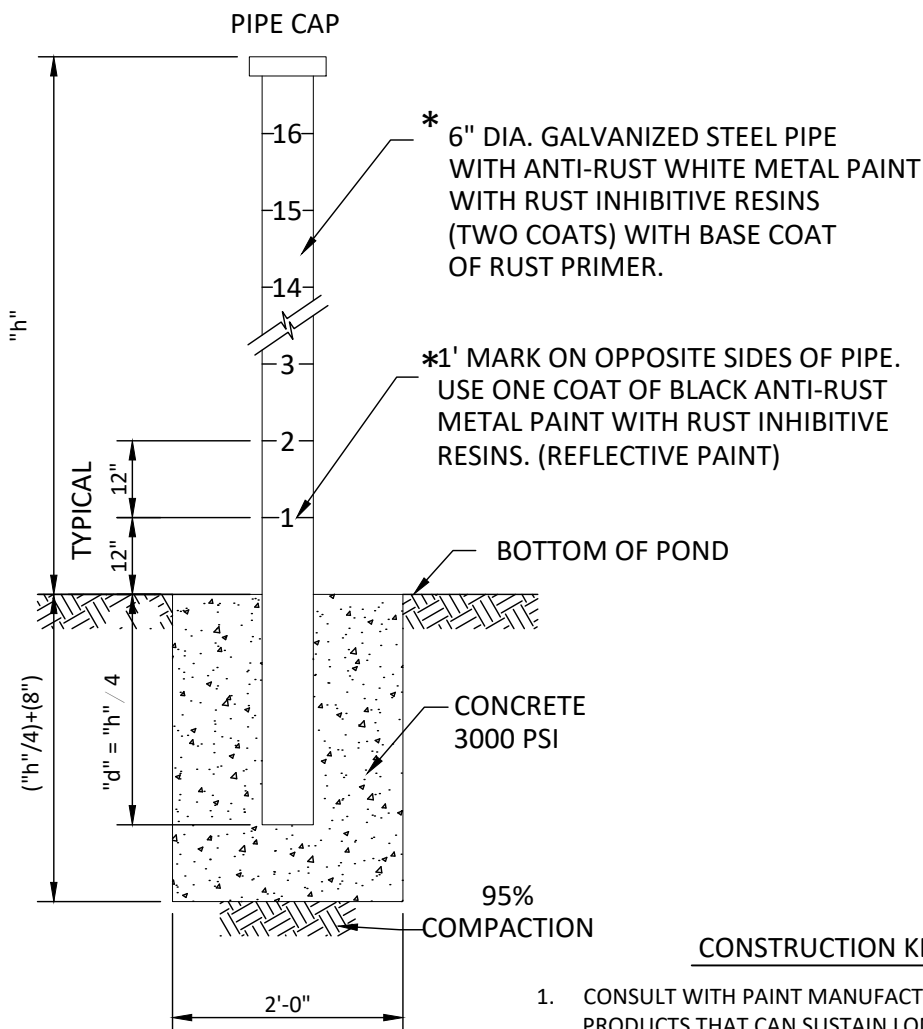

CONSTRUCTION KEY NOTES:

1. CONSULT WITH PAINT MANUFACTURER FOR PRODUCTS THAT CAN SUSTAIN LONG PERIODS OF MOISTURE.
2. "d" = DEPTH
3. "h" = HEIGHT
4. IN NO INSTANCE CAN "d" BE LESS THAN 36"





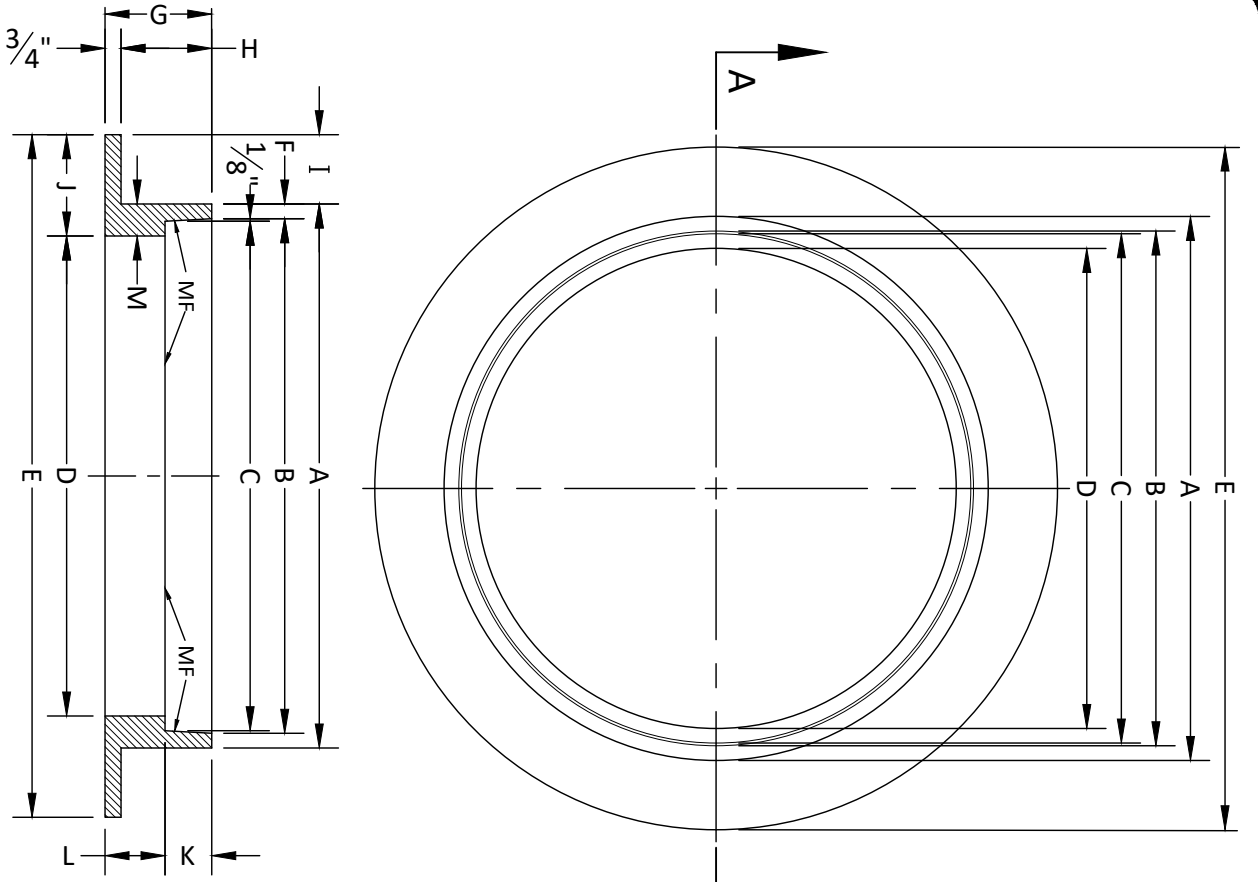

- GENERAL NOTES:**
1. MATCHING SURFACES MARKED "MF" TO BE FINISHED OF ANY IRREGULARITIES THAT WOULD PREVENT A SNUG FIT.
  2. CASTING TO BE SMOOTH & VOID OF AIR HOLES.
  3. CASTING MUST MEET REQUIREMENTS OF AASHTO M306-07.
  4. AS-CAST DIMENSIONS MAY VARY  $\frac{1}{16}$ "  $\pm$ / PER FOOT (AASHTO M306-07).
  5. WEIGHT MAY VARY 5% $\pm$  (AASHTO M306-07).
  6. SHADED DIMENSIONS IN TABLE FOR REFERENCE ONLY.
- SOURCE: CITY OF EL PASO STORMWATER DESIGN MANUAL, DETAILS 2-9 THROUGH 2-12.

MANHOLE RING	MANHOLE - ALL TYPES	MANHOLE TYPE 48"	MANHOLE TYPE 72"
A	33"	25 $\frac{1}{4}$ "	32 $\frac{3}{4}$ "
B	31 $\frac{3}{4}$ "	23 $\frac{7}{8}$ "	31 $\frac{3}{8}$ "
C	31 $\frac{1}{2}$ "	23 $\frac{5}{8}$ "	31 $\frac{1}{8}$ "
D	30"	22 $\frac{1}{2}$ "	30"
E	39 $\frac{1}{2}$ "	34 $\frac{1}{2}$ "	42"
F	5 $\frac{8}$ "	1 $\frac{1}{16}$ "	1 $\frac{1}{16}$ "
G	5"	6"	6"
H	4 $\frac{1}{4}$ "	5 $\frac{1}{4}$ "	5 $\frac{1}{4}$ "
I	3 $\frac{1}{4}$ "	4 $\frac{1}{16}$ "	4 $\frac{1}{16}$ "
J	4 $\frac{3}{4}$ "	6"	6"
K	2 $\frac{3}{16}$ "	3 $\frac{1}{16}$ "	3 $\frac{1}{16}$ "
L	2 $\frac{13}{16}$ "	2 $\frac{15}{16}$ "	2 $\frac{15}{16}$ "
M	1 $\frac{1}{2}$ "	1 $\frac{3}{8}$ "	1 $\frac{3}{8}$ "
WEIGHT	220 lbs.	165 lbs.	225 lbs.

SEE NOTE 6



TITLE 19 - SUBDIVISION ORDINANCE  
 STORMWATER DESIGN MANUAL  
 CONSTRUCTION DETAILS

MANHOLE RING

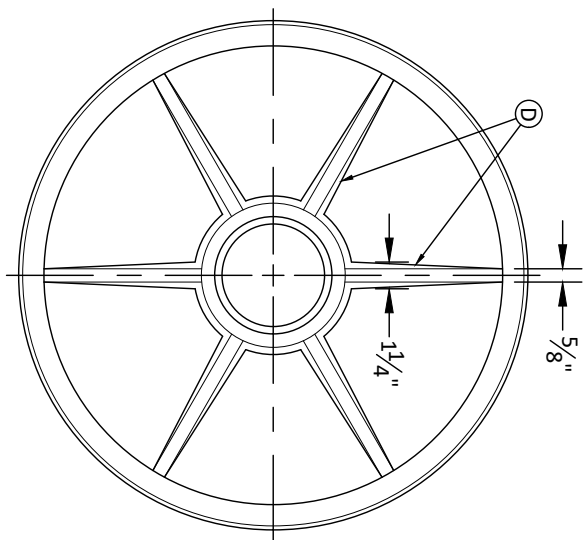
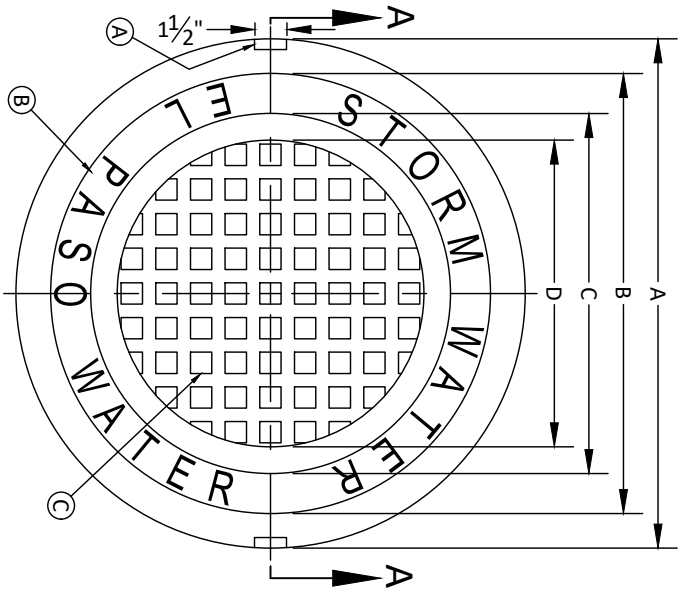

TOP VIEW

BOTTOM VIEW

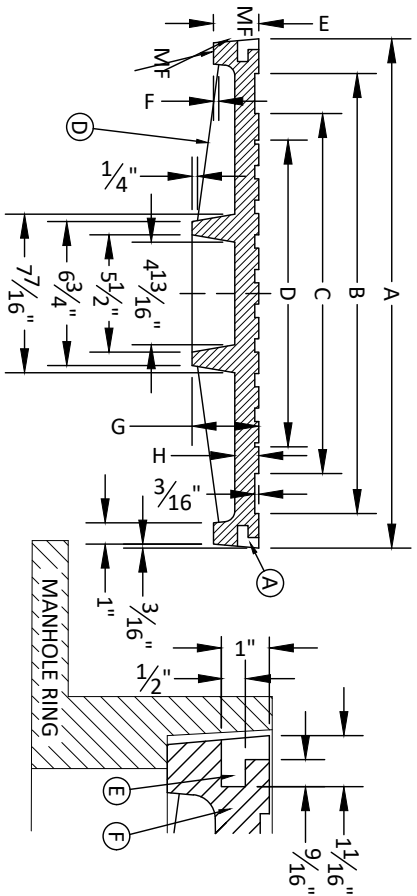

A-A

LIFTING NOTCH

MANHOLE COVER	MANHOLE - ALL TYPES	MANHOLE TYPE 48"	MANHOLE TYPE 72"
A	31 3/8"	23 3/4"	31 1/4"
B	28 1/8"	20 5/8"	28 1/8"
C	24 3/8"	16 7/8"	24 3/8"
D	21 7/8"	14 3/8"	21 7/8"
E	2 1/8"	3"	3"
F	1/4"	1 1/4"	1 1/4"
G	3 1/8"	3"	3"
H	1 1/8"	1"	1"
WEIGHT	265 lbs.	175 lbs.	310 lbs.

SEE NOTE 6

- GENERAL NOTES:**
1. MATCHING SURFACES MARKED "MF" TO BE FINISHED OF ANY IRREGULARITIES THAT WOULD PREVENT A SNUG FIT.
  2. CASTING TO BE SMOOTH & VOID OF AIR HOLES.
  3. CASTING MUST MEET REQUIREMENTS OF AASHTO M306-07.
  4. AS-CAST DIMENSIONS MAY VARY 1/6" ± PER FOOT (AASHTO M306-07).
  5. WEIGHT MAY VARY 5% ± (AASHTO M306-07).
  6. SHADED DIMENSIONS IN TABLE FOR REFERENCE ONLY. SOURCE: CITY OF EL PASO STORMWATER DESIGN MANUAL, DETAILS 2-9 THROUGH 2-12.

**CONSTRUCTION KEY NOTES:**

- A. LIFTING NOTCH:**  
 B. 3/16" RAISED LETTERING.  
 C. 1" SQUARES (3/16" TALL) WITH 5/8" SPACE BETWEEN.  
 D. REINFORCING RIBS.  
 E. SLOT.  
 F. MANHOLE COVER



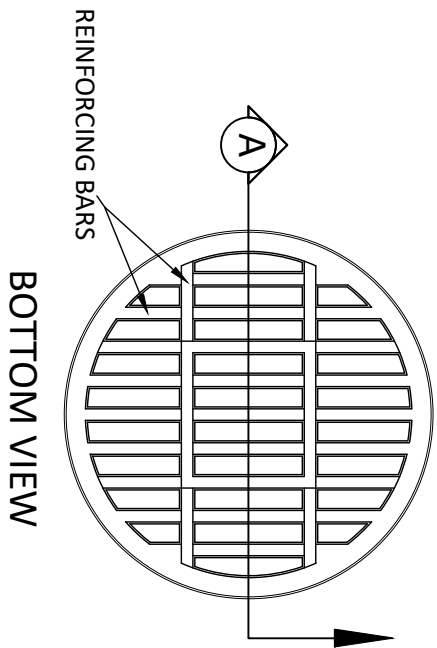
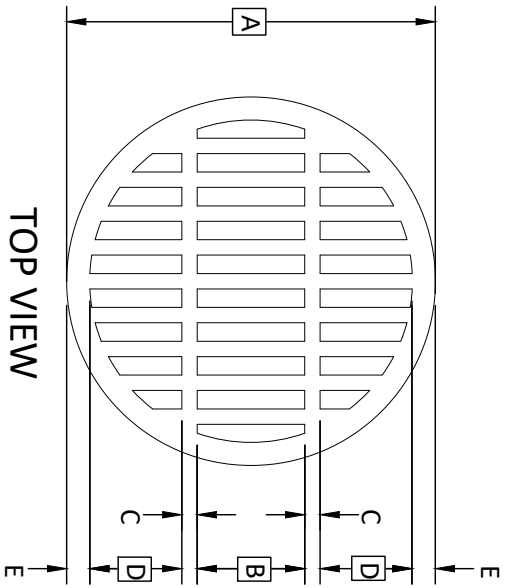

**TOP VIEW**  
NTS

**BOTTOM VIEW**  
NTS

**NOTE:**

THIS MANHOLE COVER FITS IN A STANDARD MANHOLE RING  
(SEE 2-5)

**GENERAL NOTES:**

1. MATCHING SURFACES MARKED "MF" TO BE MACHINE FINISHED OF ANY IRREGULARITIES THAT WOULD PREVENT A SNUG FIT.
2. CASTING TO BE SMOOTH AND VOID OF AIR HOLES.

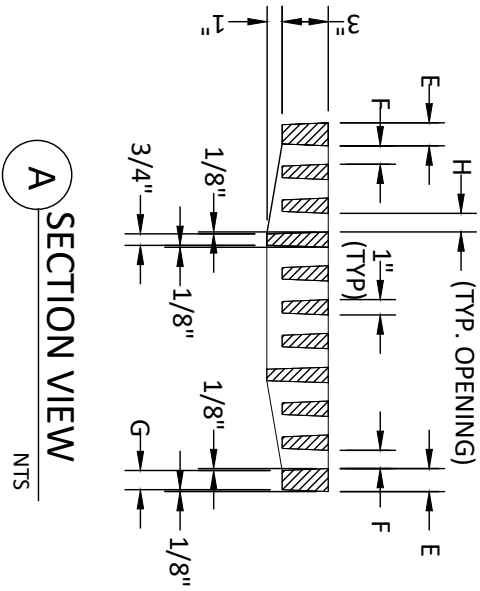

**SECTION VIEW**  
NTS

MANHOLE COVER WEIGHT	48" MANHOLE	72" MANHOLE
A	1'-11 3/4"	2'-7 1/4"
B	6 1/2"	9"
C	1"	1 1/2"
D	6"	8"
E	1 5/8"	1 5/8"
F	1 1/4"	1"
G	1 3/8"	1 3/8"
H	1"	1"



CONCRETE APRON FOR CIRCULAR PENETRATIONS IN ASPHALT PAVEMENTS				
"D" DIAMETER OF PENETRATION (INCHES)	"A" CONCRETE HORIZONTAL DIMENSION FROM PENETRATION (INCHES)	NUMBER OF NO. 3 REINFORCING STEEL BARS	"B" MINIMUM CLEARANCE FROM EDGE OF CONCRETE APRON TO CENTER OF NEAREST REBAR (INCHES)	"C" MINIMUM CLEARANCE FROM PENETRATION EDGE TO CENTER OF NEAREST REBAR (INCHES)
0 TO 6.01	6	1	1½	1½
6.01 TO 18.01	8	2	1½	1½
18.01 AND OVER	12	3	1½	1½

**CONSTRUCTION NOTES:**

1. ANY DISTURBED SUBGRADE UNDER THE CONCRETE APRON SHALL BE COMPACTED TO 95% DENSITY ± 3% OPTIMUM MOISTURE CONTENT IN ACCORDANCE WITH ASTM D-1557.
2. ANY DISTURBED COARSE UNDER THE CONCRETE APRON SHALL BE COMPACTED TO 100% DENSITY ± 2% OPTIMUM MOISTURE CONTENT IN ACCORDANCE WITH ASTM D-1557.
3. PROVIDE A MINIMUM OF 1.1/2" OF CONCRETE COVER FOR ALL REINFORCEMENT STEEL.
4. REINFORCING SHALL MEET ASTM C-478 AND TRAFFIC LOADING (HS-20).
5. NO. 3 REINFORCING STEEL HOOPS SHALL BE SPACED EQUALLY.

**GENERAL NOTES:**

1. THE PENETRATION APRON SHOULD BE CAST IN-PLACE CONCRETE. (MINIMUM 28 DAY COMPRESSIVE STRENGTH 4000 PSI. HIGH EARLY CONCRETE IS REQUIRED)
2. TOPS OF PENETRATION APRON SHALL BE FLUSH WITH ROADWAY SURFACE OR FINISHED GRADE UNLESS OTHERWISE SPECIFIED BY THE CITY ENGINEER.

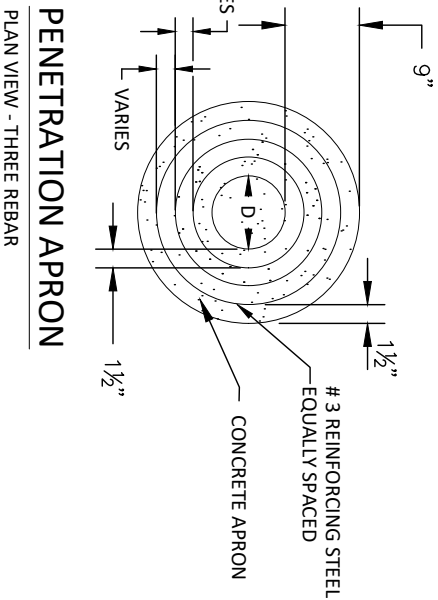
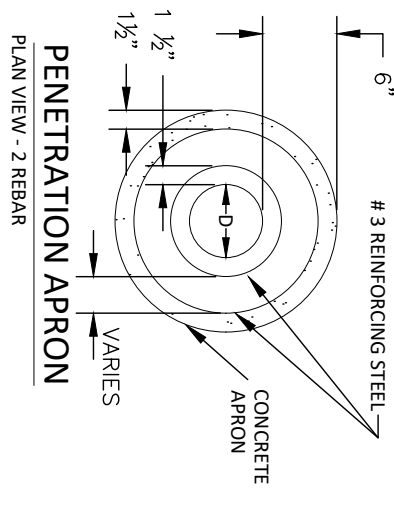
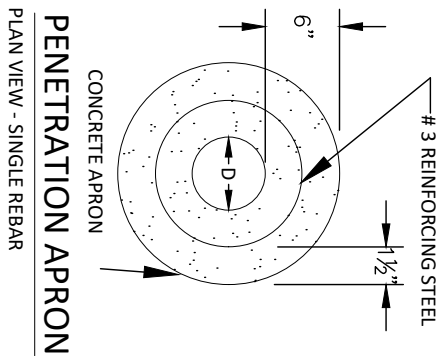
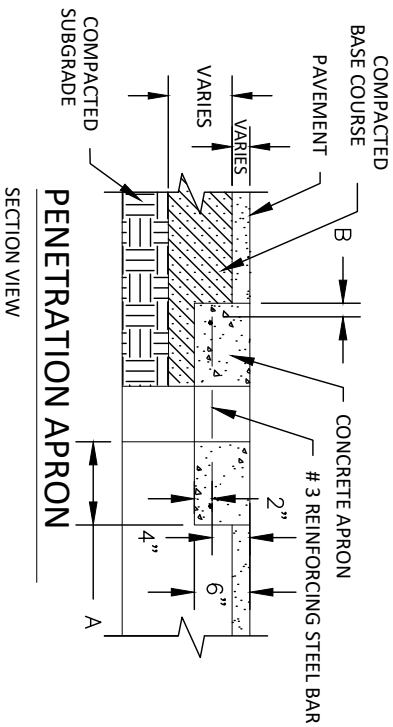

**PENETRATION APRON**



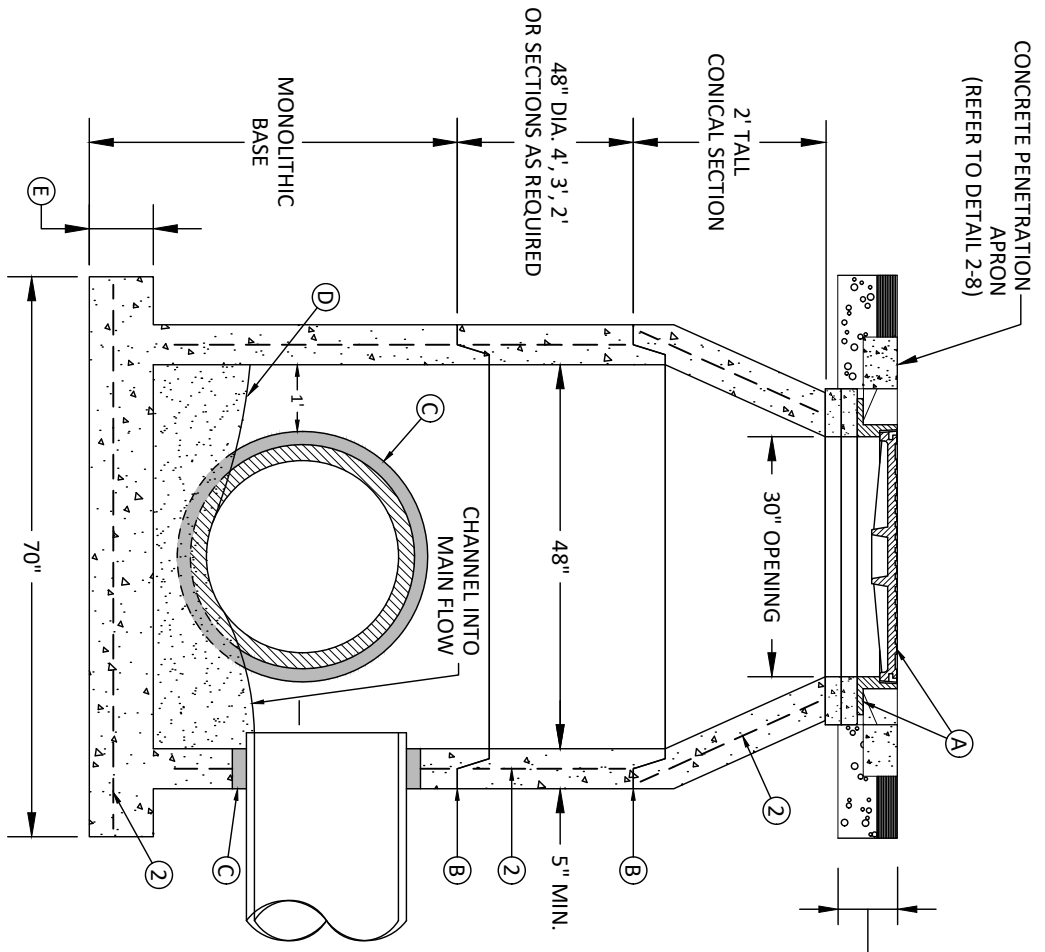

SECTION  
NTS

**GENERAL NOTES:**

1. MANHOLE TYPE "S-A" SHALL BE USED FOR LINES 24" AND SMALLER.
2. PRE-CAST MANHOLE SECTIONS SHALL BE OF REINFORCED CONCRETE CONFORMING TO ASTM C-478 AND SHALL MEET HS-20 LOADING. PROVIDE REINFORCEMENT WITHIN 3" @ OPENINGS OR KNOCKOUTS, OPENINGS (UP TO 8") MADE IN FIELD SHALL BE CORE DRILLED.
3. CEMENT SHALL BE TYPE I-II, PER ASTM C-150, AND MUST CONTAIN A MINIMUM OF 4% FLY ASH OF THE TOTAL MANHOLE WEIGHT.
4. THE BASE & RISER SHALL BE INTEGRALLY CAST. CONCRETE SHALL BE MIN. 28 DAY COMPRESSIVE STRENGTH 4000psi.
5. MANUFACTURER TO PROVIDE LIFTERS OF ADEQUATE SIZE AS NEEDED.
6. THE SUBGRADE UNDER THE BASE SHALL BE COMPACTED TO 95% DENSITY IN ACCORDANCE WITH ASTM D-1557.
7. MANHOLES BELOW GROUNDWATER TO BE EXTERNALLY AND INTERNALLY COATED WITH BITUMINOUS COATING.

**CONSTRUCTION KEY NOTES:**

- A. MANHOLE RING AND COVER (SEE DETAILS 2-4 & 2-5). SET FRAME AND COVER FLUSH WITH ROADWAY SURFACE OR FINISHED GRADE.
- B. ALL JOINTS TO BE TONGUE, GROOVE AND SEALED WITH MORTAR OR RAM-NEK (OR APPROVED EQUAL).
- C. PIPE OPENINGS/KNOCKOUTS AS REQUIRED TO FIT PIPE SIZE AND SHALL HAVE FLEXIBLE PIPE TO MANHOLE CONNECTORS (COMPRESSION TYPE ASTM-923), "KOR-N-SEAL" OR APPROVED EQUAL
- D. GROUT AS REQUIRED.
- E. CONCRETE BASE SHALL BE 8" FOR MH'S UP TO 12' DEEP AND 12" FOR DEPTHS GREATER THAN 12'.



TITLE 19 - SUBDIVISION  
ORDINANCE  
**STORMWATER DESIGN MANUAL**  
CONSTRUCTION DETAILS

**48" DIAMETER  
STANDARD PRE-CAST  
CONICAL MANHOLE**

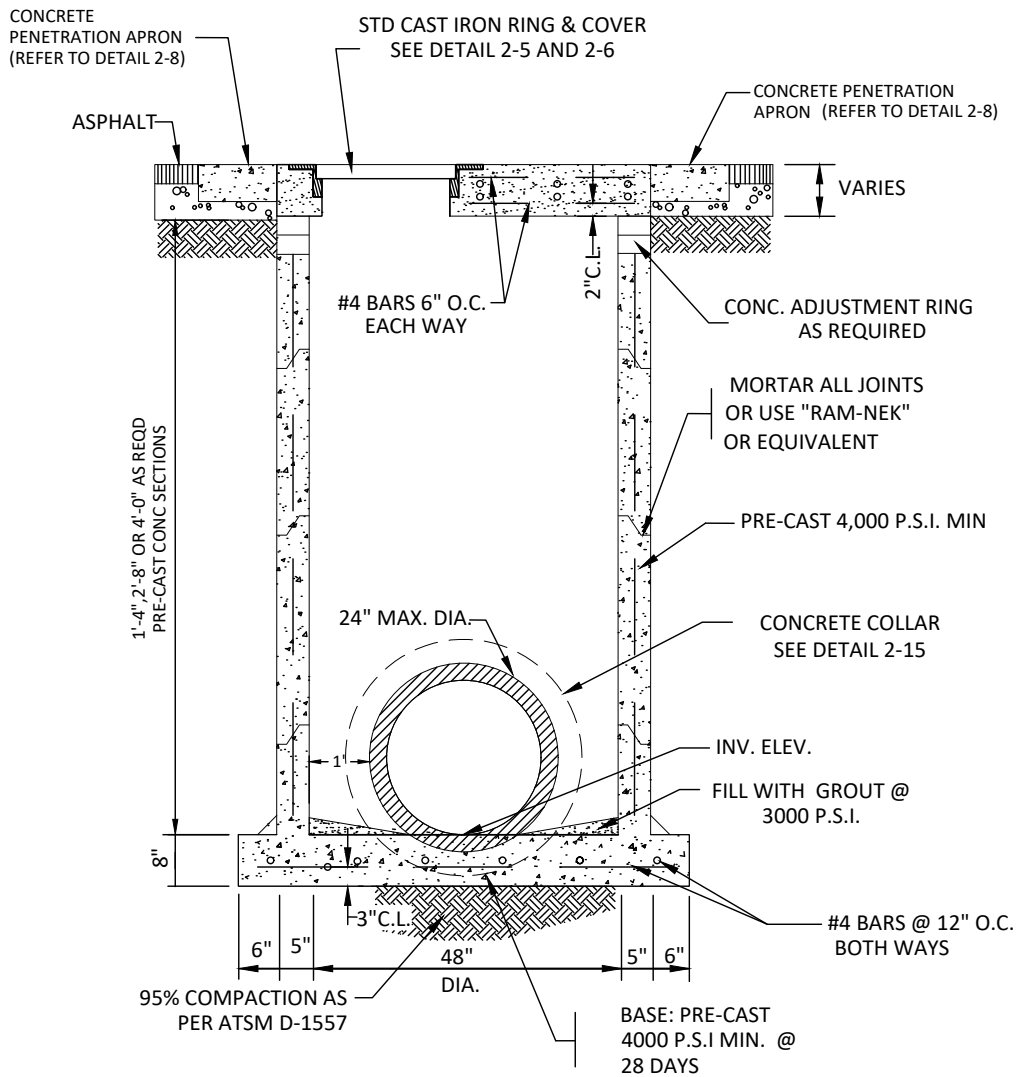

**48" DIAMETER PRE-CAST STRAIGHT MANHOLE SECTIONS**



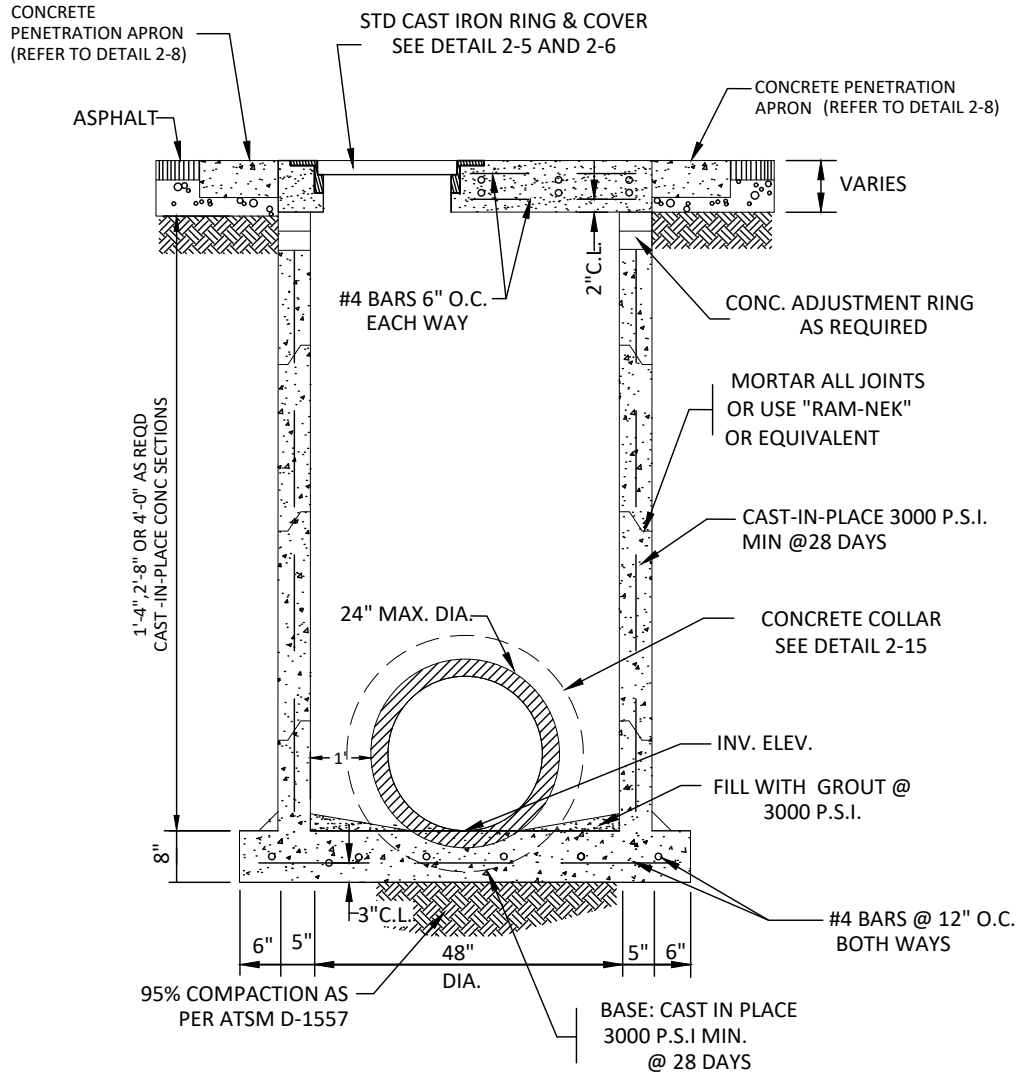

**48" DIAMETER CAST-IN-PLACE STRAIGHT MANHOLE SECTIONS**



TITLE 19 - SUBDIVISION  
ORDINANCE

STORMWATER DESIGN MANUAL  
CONSTRUCTION DETAILS

Appendix 2

48" DIAMETER  
CAST-IN-PLACE  
MANHOLE

2-11

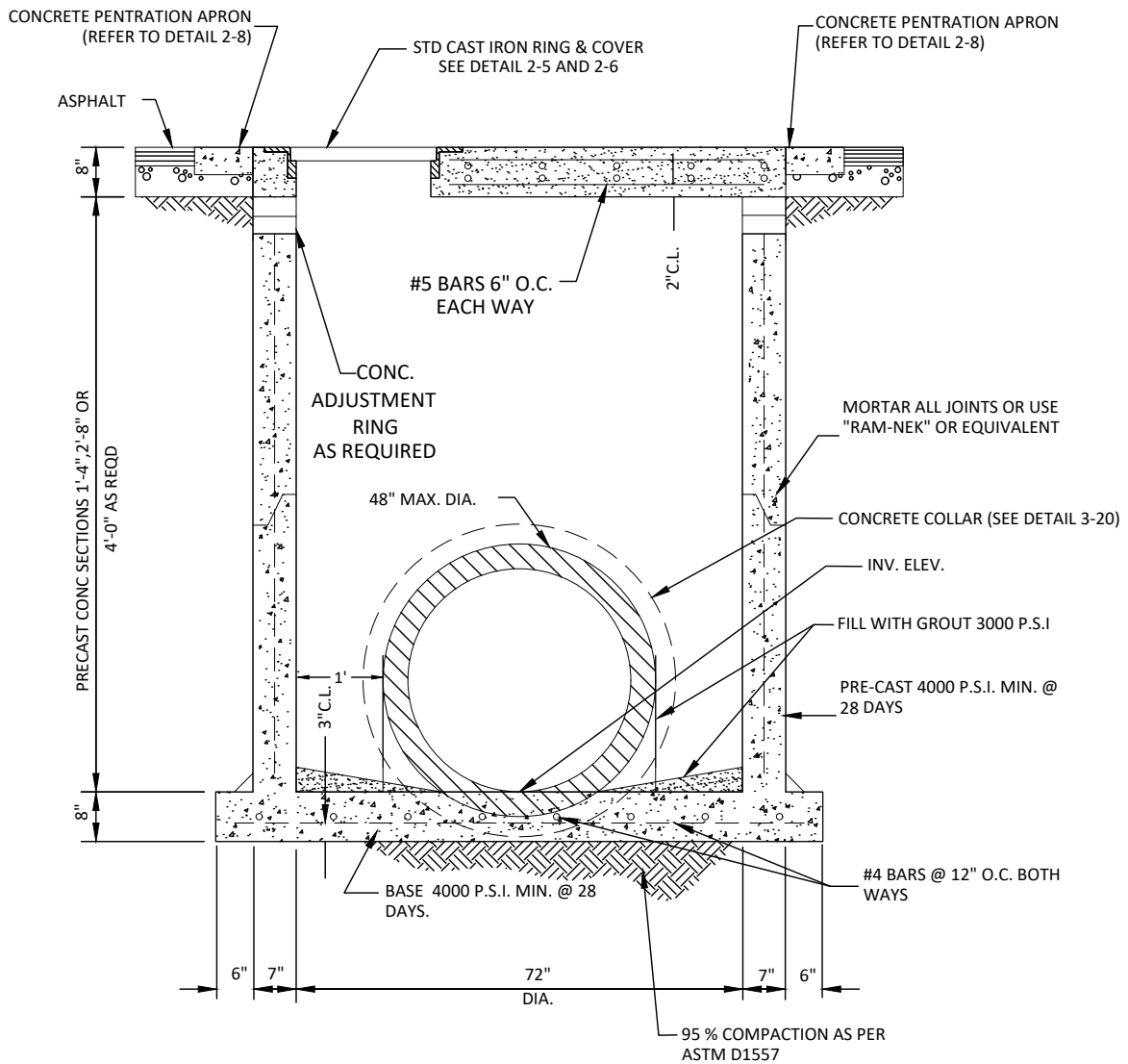

**72" DIAMETER PRECAST STRAIGHT MANHOLE SECTIONS**

NTS



TITLE 19 - SUBDIVISION  
ORDINANCE

STORMWATER DESIGN MANUAL  
CONSTRUCTION DETAILS

Appendix 2

72" DIAMETER  
PRE-CAST MANHOLE

2-12



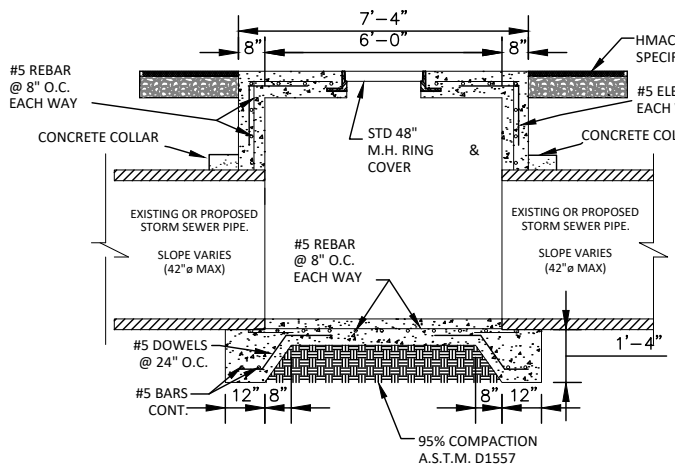

**SECTION A-A**

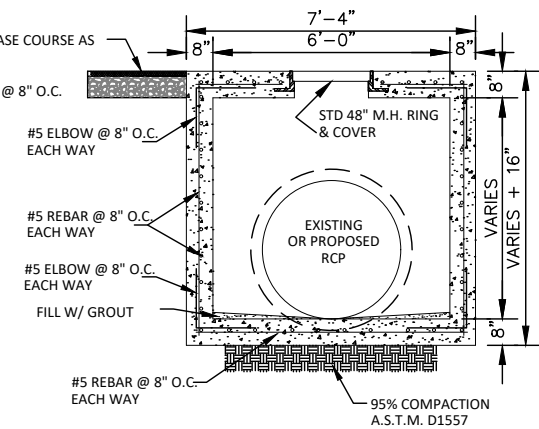

**SECTION B-B**

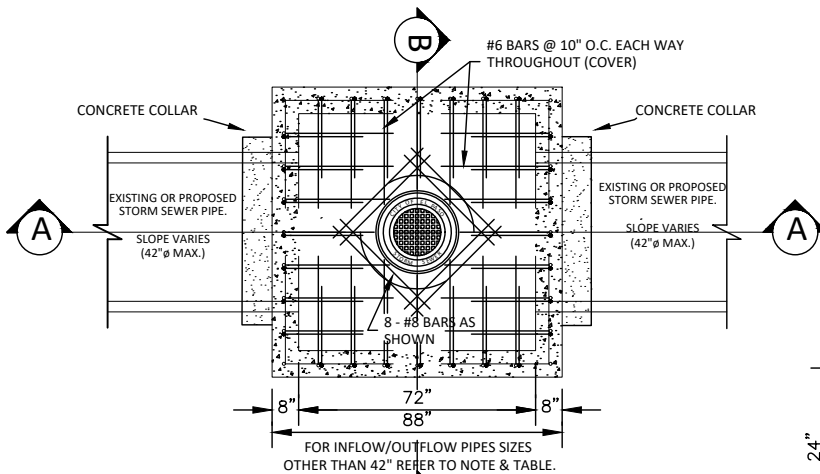

**72" JUNCTION BOX**

\* INCLUDE NOTE FOR COMPACTION AT ALL SIDES OF THE STRUCTURE

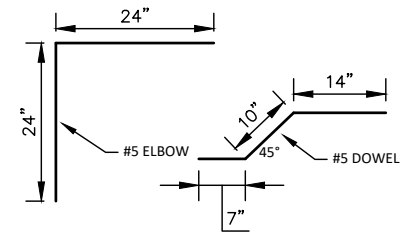

**BENDING DETAIL**



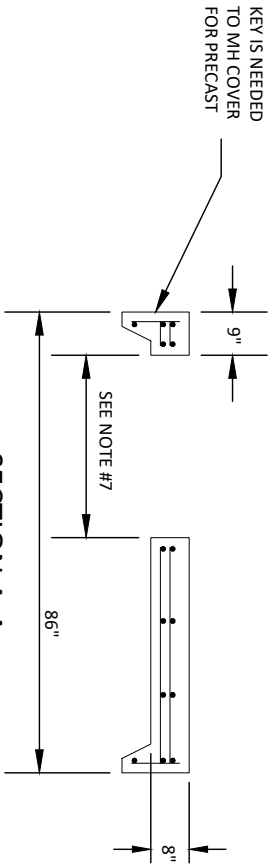

SECTION A-A

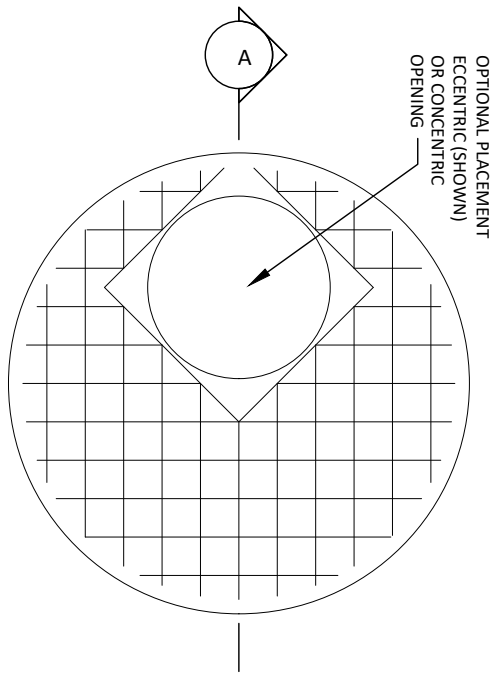

MANHOLE COVER FOR 72" MANHOLE

NTS

**GENERAL NOTES:**

1. ALL JOINTS TO BE TONGUE AND GROOVE AND SEALED WITH RAM-NEK OR EQUAL.
2. MANUFACTURER TO PROVIDE LIFTERS OF ADEQUATE SIZE AS NEEDED.
3. 4000 P.S.I. CONCRETE 28 DAYS.
4. KEYLOCK ADDS 8" TO VERTICAL HEIGHTS.
5. RING & COVER OR SPECIAL LIDS TO MEET REQUIREMENTS. MAY BE CAST IN PLACE.
6. REINFORCING SHALL MEET A.S.T.M. C478-87 AND TRAFFIC LOADING (HS-20).
7. SIZE TO ACCOMMODATE TYPE 72" DIAMETER MANHOLE RING



GENERAL NOTES:

1. A CONCRETE COLLAR IS REQUIRED WHERE PIPES CHANGE IN HORIZONTAL OR VERTICAL ALIGNMENT.
2. FOR PIPES 24" OR LESS IN DIAMETER REINFORCE WITH W.W.M
3. FORMS REQUIRED TO NOT EXCEED DIM.

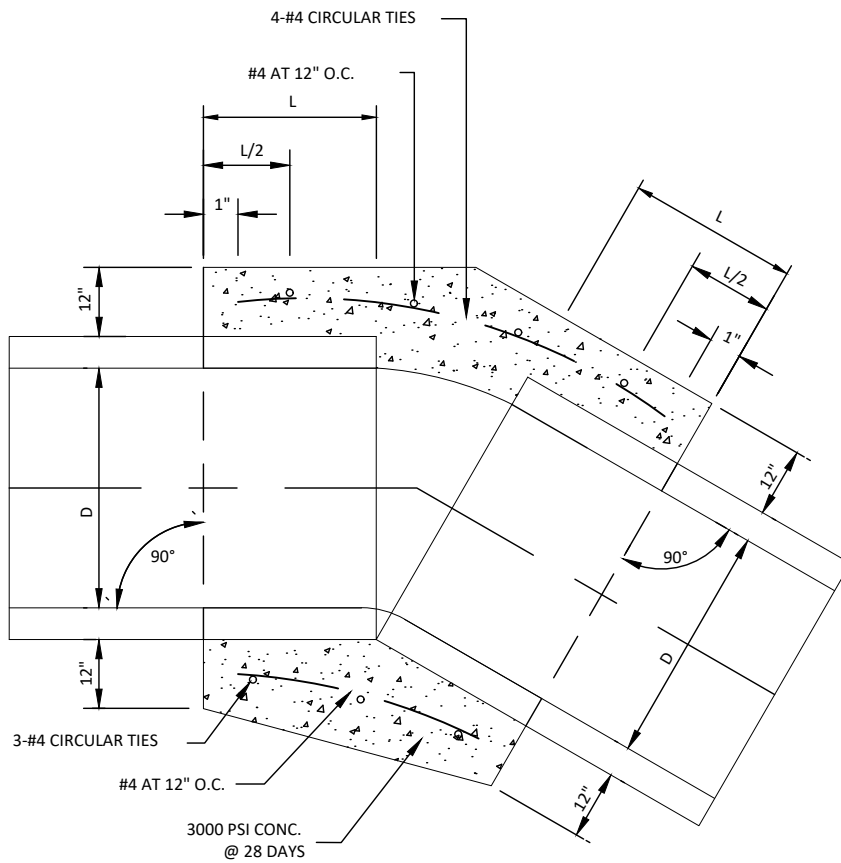

D	L
12"	12"
18"	12"
24"	12"
36"	18"
48"	18"
54"	18"
60"	21"
66"	21"



TITLE 19 - SUBDIVISION  
ORDINANCE

STORMWATER DESIGN MANUAL  
CONSTRUCTION DETAILS

Appendix 2

CONCRETE PIPE  
COLLAR

2-15

**GENERAL NOTES:**  
 1. NOT TO BE USED UNDER GROUND WATER CONDITIONS.

**CONSTRUCTION KEY NOTES:**

- A. PROPOSED R.C.P. PIPE.
- B. CONCRETE COLLAR (3000 PSI CONCRETE).
- C. INSIDE WALL OF EXISTING MANHOLE OR PRECAST STRUCTURE.
- D. #4's @ 12" O.C.
- E. 2-#4 CIRCULAR TIES.
- F. NON-SHRINK GROUT TO BE PLACED BETWEEN EXISTING MANHOLE AND RCP TO COVER ALL GAPS (TYPICAL). THE AREA BETWEEN THE EXISTING MANHOLE/STRUCTURE AND THE RCP SHALL BE 1/2 OF THE WALL THICKNESS OF THE EXISTING STRUCTURE.
- G. MANHOLE BASE.

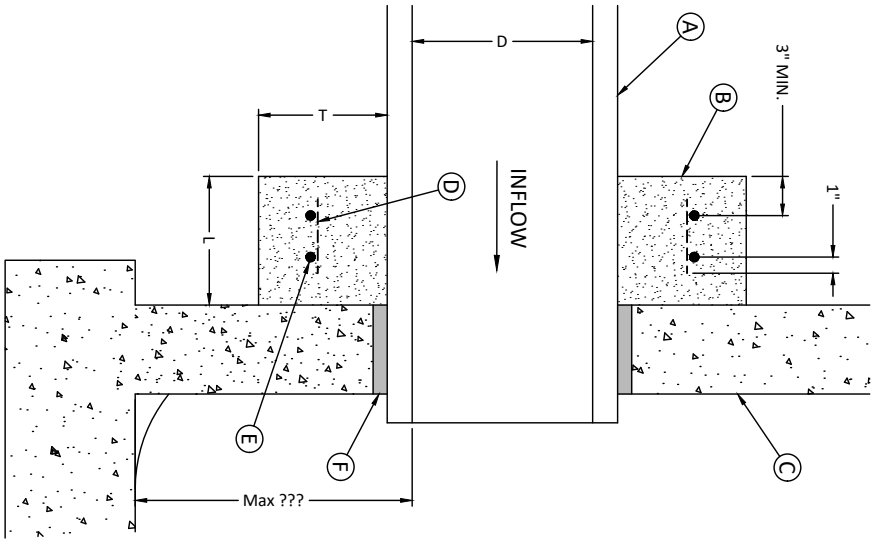

**DROP CONNECTION**  
 NTS

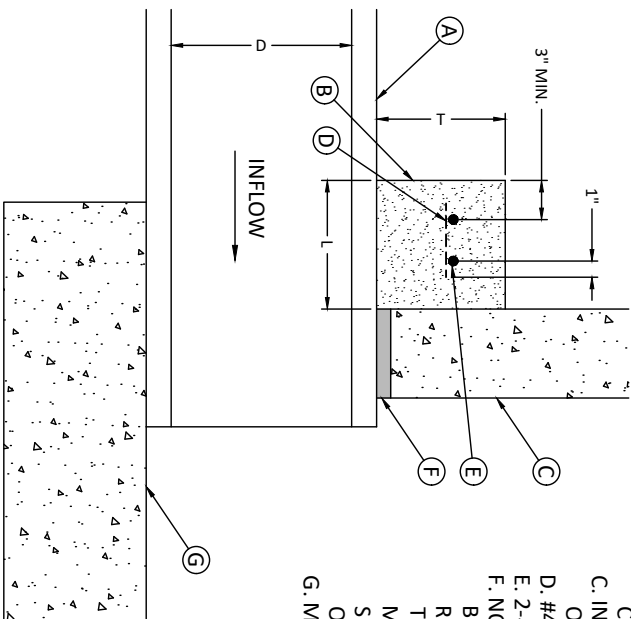

**CONNECTION AT BASE**  
 NTS

TABLE		
D	L	T
12"	12"	12"
18"	12"	12"
24"	12"	12"
30"	12"	12"
36"	18"	18"
42"	18"	18"

**CONNECTION AT PRECAST JUNCTION BOXES OR EXISTING MANHOLES**



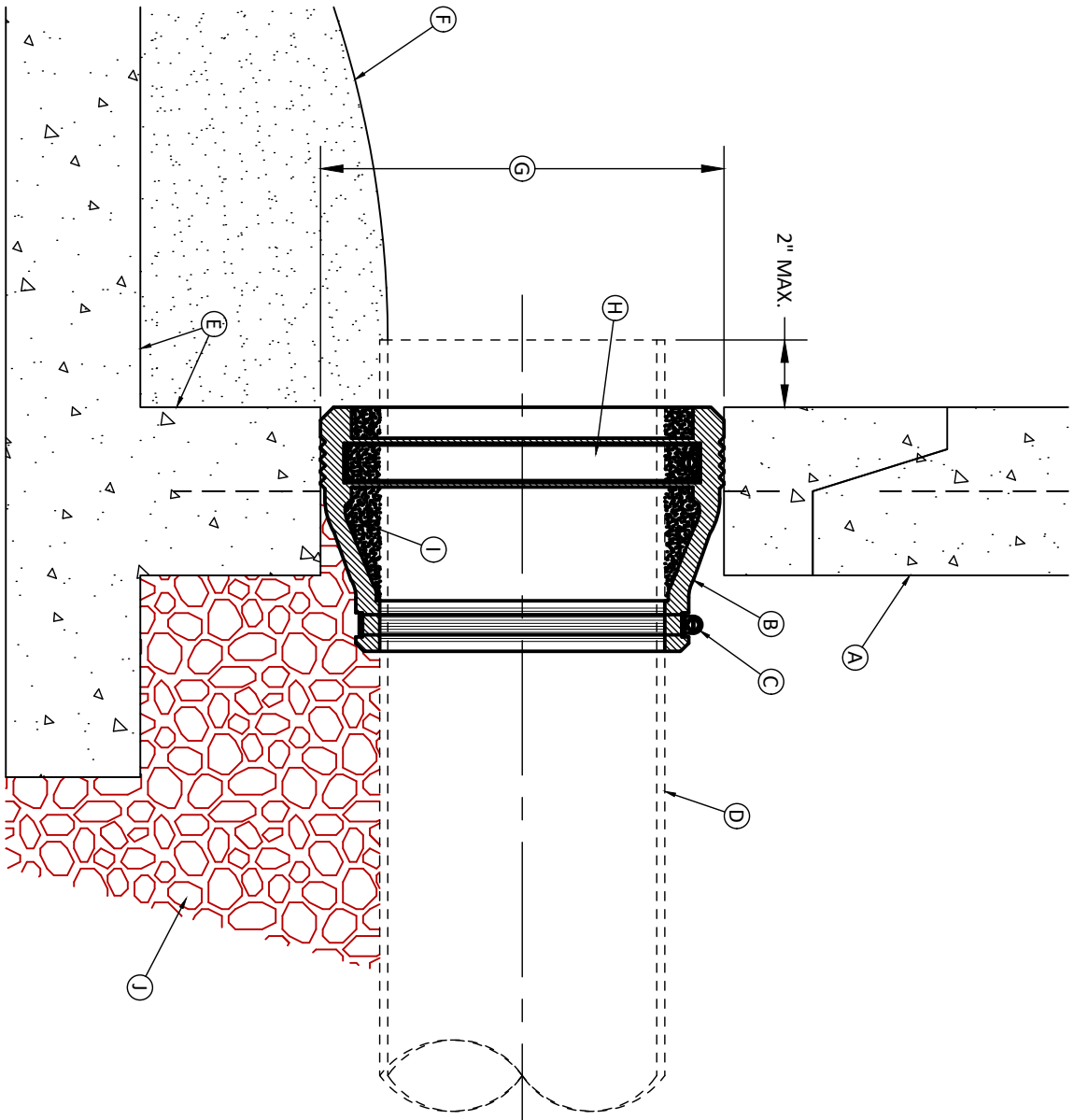

**GENERAL NOTES:**  
 1. MANHOLE CONNECTOR SHALL BE KOR-N-SEAL OR EQUAL MEETING THE REQUIREMENTS OF ASTM C-923. CONNECTOR SHALL BE FURNISHED BY CONTRACTOR.

**CONSTRUCTION KEY**

**NOTES:**

- A. PRECAST MANHOLE BARREL.
- B. FLEXIBLE CONNECTOR.
- C. PIPE CLAMP SS 316.
- D. APPROVED PIPE.
- E. PRECAST MANHOLE BASE.
- F. GROUT AS REQUIRED TO FORM SMOOTH CHANNEL TO MANHOLE INVERT.
- G. PIPE OPENINGS/KNOCKOUTS AS REQUIRED TO FIT PIPE SIZE.
- H. EXPANSION BAND SS 316.
- I. FILL SPACE WITH GROUT.
- J. SUPPORT PIPE TO UNDISTURBED GROUND WITH CLASS I GRAVEL PER ASTM D-2321 AND D-2487.



TITLE 19 - SUBDIVISION  
 ORDINANCE  
 STORMWATER DESIGN MANUAL  
 CONSTRUCTION DETAILS

PLASTIC PIPE  
 CONNECTION TO  
 STORMWATER MANHOLE  
 WATERTIGHT SEAL

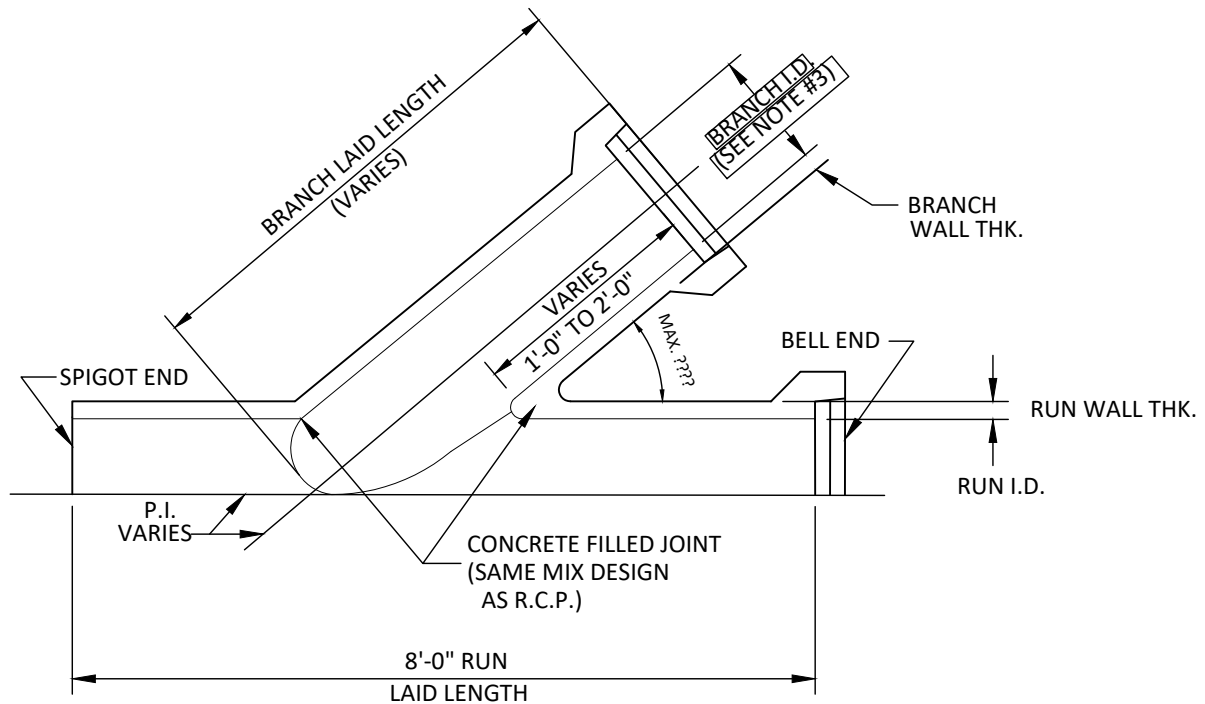

REINFORCED CONCRETE PIPE - WYE 18" THRU 96" DIA.

PLAN VIEW SECTION

N.T.S.

CONSTRUCTION KEY NOTES:

- 1) THIS DRAWING IS NOT INTENDED TO SHOW REINFORCEMENT DESIGN EITHER AS TO PLACEMENT OR STEEL AREA. ACTUAL PROJECT SPECIFICATIONS WILL GOVERN.
- 2) STEEL AREA IN WYE CONNECTION EXCEEDS THAT REQUIRED IN ADJACENT PIPE.
- 3) FOR 18" DIA. TO 30" DIA. MAINLINE R.C.P. THE DIA. OF THE WYE NEEDS TO BE 6" SMALLER THAN THE MAINLINE DIA. FOR 36" DIA. TO 96" DIA. MAINLINE R.C.P. THE DIA. OF THE WYE NEEDS TO BE 12" SMALLER THAN THE MAINLINE DIA.



TITLE 19 - SUBDIVISION  
ORDINANCE  
STORMWATER DESIGN MANUAL  
CONSTRUCTION DETAILS

Appendix 2

PRE-FABRICATED  
REINFORCED  
CONCRETE PIPE WYE

2-18

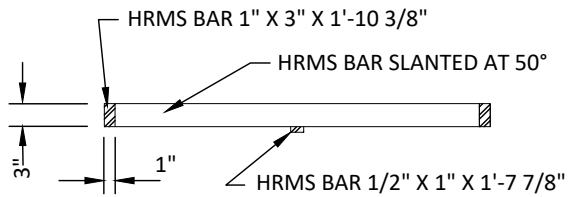

**C** GRATE SECTION  
NTS

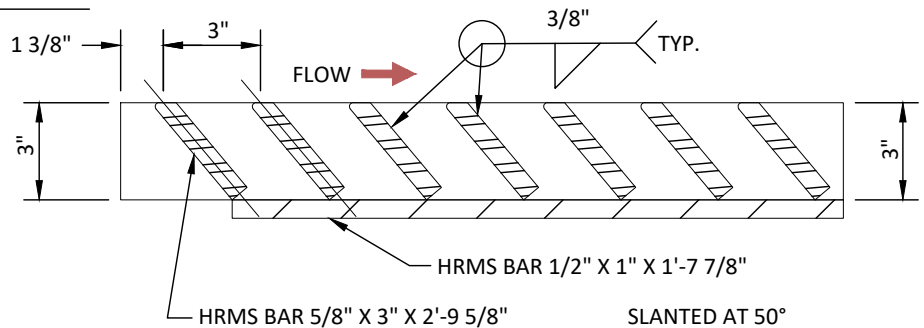

**B** GRATE SECTION  
NTS

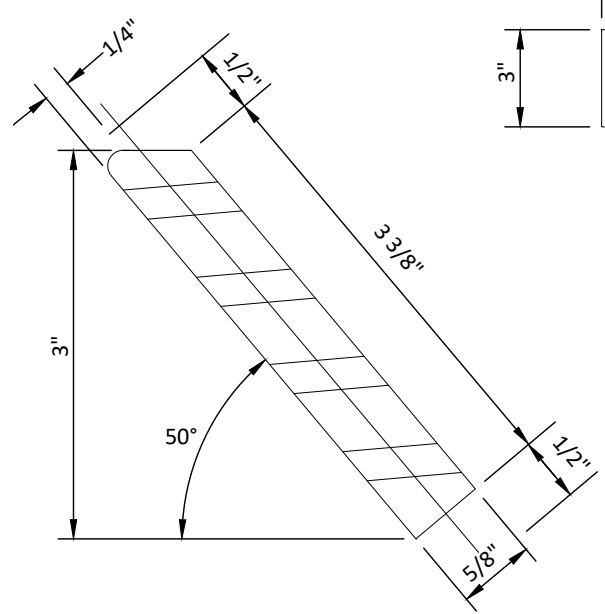

SLANTED BAR DETAIL  
NTS

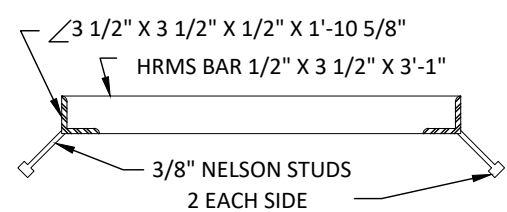

**A** FRAME SECTION  
NTS

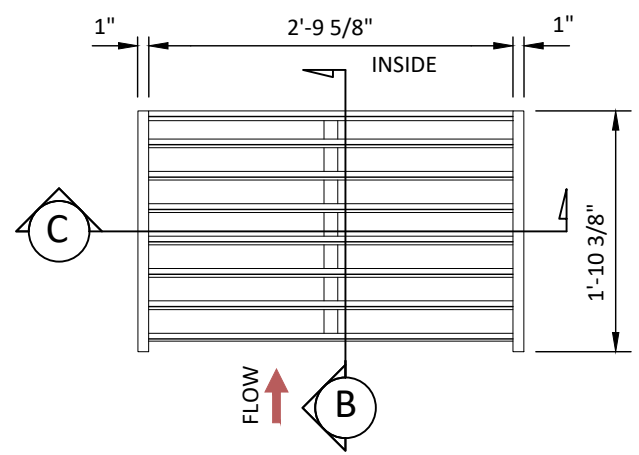

GRATE  
NTS

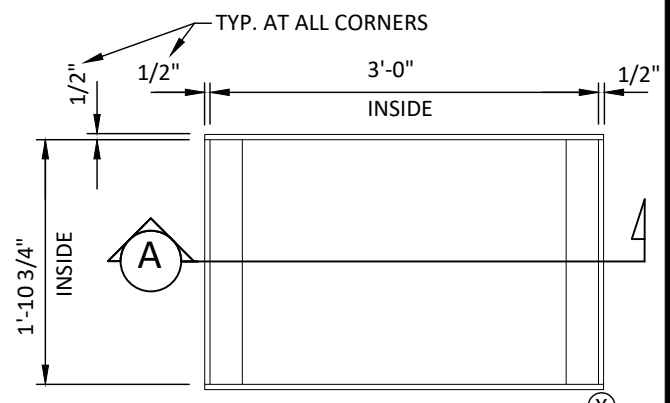

FRAME  
NTS



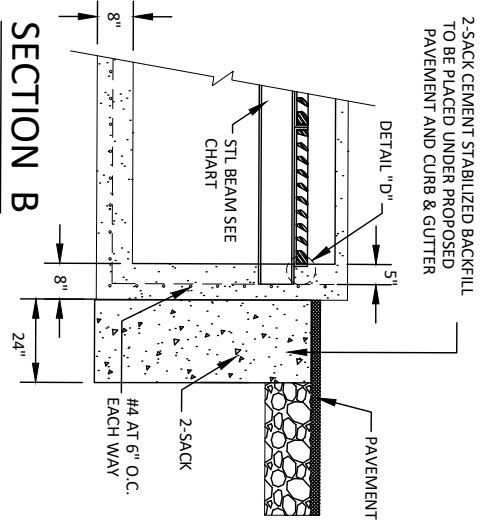
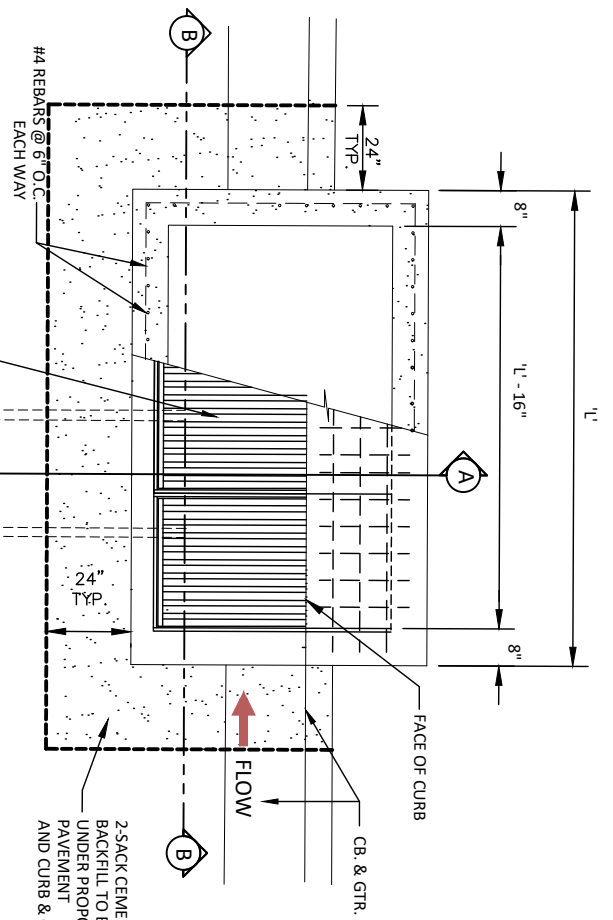

**PLAN VIEW**  
NTS

2-SACK CEMENT STABILIZED BACKFILL TO BE PLACED UNDER PROPOSED PAVEMENT AND CURB & GUTTER

2-SACK CEMENT STABILIZED BACKFILL TO BE PLACED UNDER PROPOSED PAVEMENT AND CURB & GUTTER.

**DETAIL "C"**  
NTS

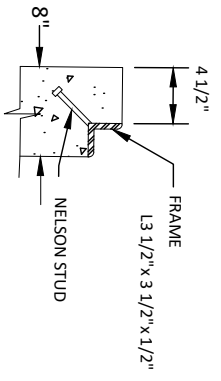

**DETAIL "D"**  
NTS

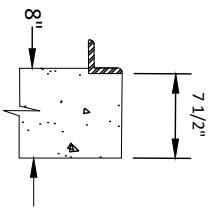

**DETAIL "B"**  
SEE DETAIL

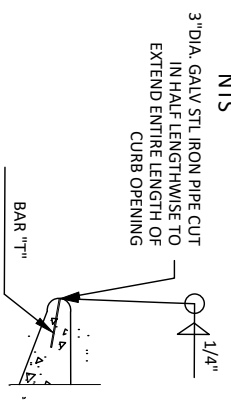

- NOTES  
 1. H = 10' MAXIMUM  
 2. CONCRETE TO BE 3000 PSI MIN CORE TEST @ 28 DAYS, IF PRECAST 4000 PSI  
 3. GRATE TO BE PERPENDICULAR TO TRAFFIC.

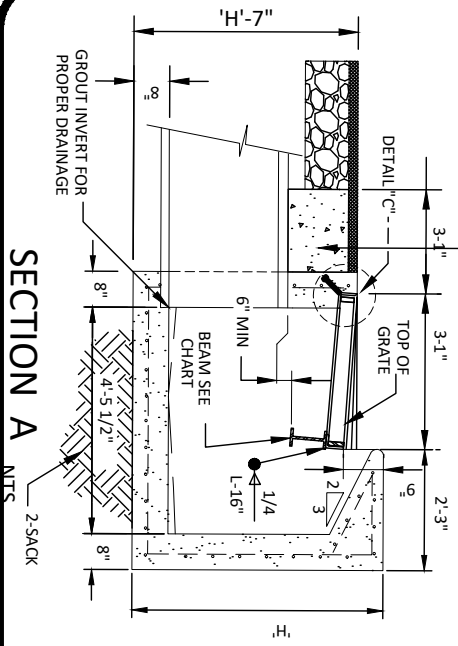

**SECTION A**  
NTS

NO. OF GRATES	L'	LENGTH	BEAM	
			MINIMUM SIZES	
2	5'-2 1/2"	4'-7 1/8"	W6X12, S6X12.5, MC6X15.1	
3	7'-2 1/4"	6'-5 1/8"	W8X15, S7X15.3, MC7X17.6	
4	9'-2"	8'-3 7/8"	W9X18, S8X18.4, MC10X21.9	
5	11'-1 3/4"	10'-2"	W12X16, S8X21, MC10X21.9	
6	13'-1 1/2"	12'-0 5/8"	W12X19, S8X23, MC10X25	

**BAR "T"**  
NTS

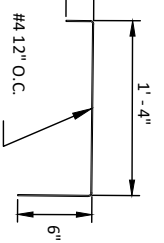

TITLE 19 - SUBDIVISION ORDINANCE  
 STORMWATER DESIGN MANUAL  
 CONSTRUCTION DETAILS



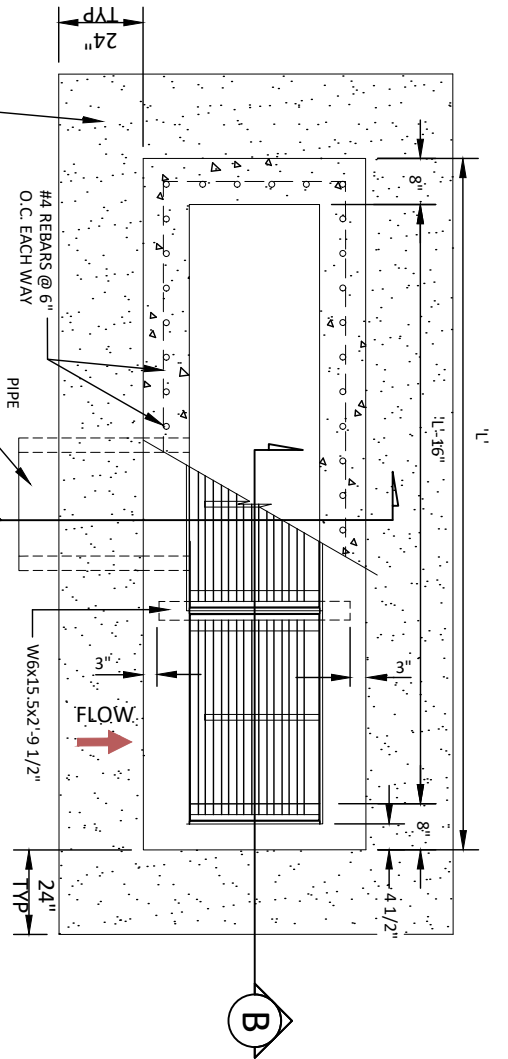

**PLAN VIEW**  
NTS

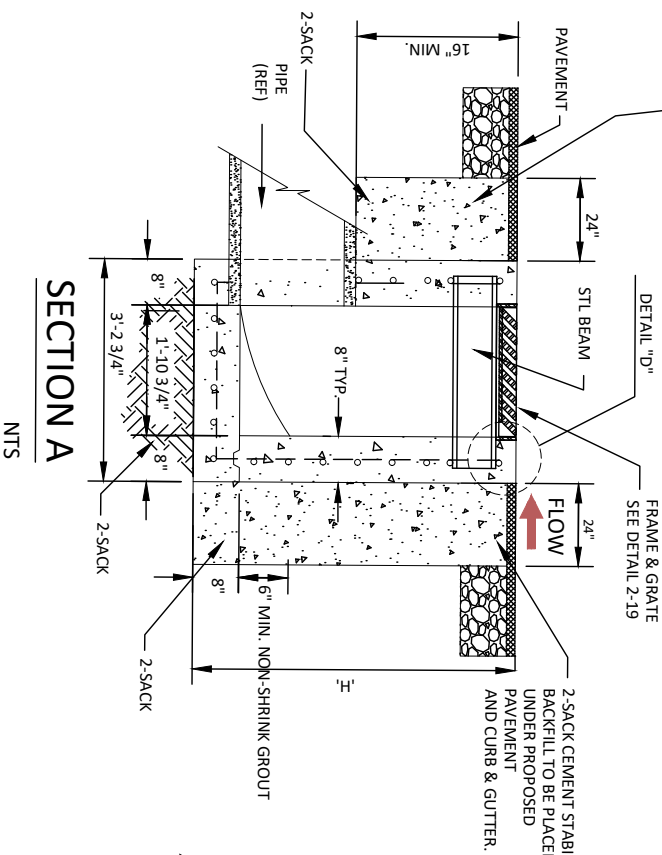

**SECTION A**  
NTS

**DETAIL "C"**

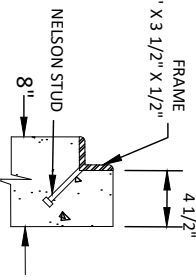

**DETAIL "D"**

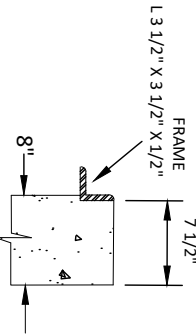

NUMBER OF GRATES	1'
2	6'-11"
3	10'-0"
4	13'-1"
5	16'-2"

- NOTES  
 1. H = 20' MAXIMUM  
 2. CONCRETE TO BE 3000 PSI MIN CORE TEST @ 28 DAYS.  
 3. GRATE TO BE PERPENDICULAR TO TRAFFIC.  
 4. STEEL (GRATES)

**SECTION B**  
NTS

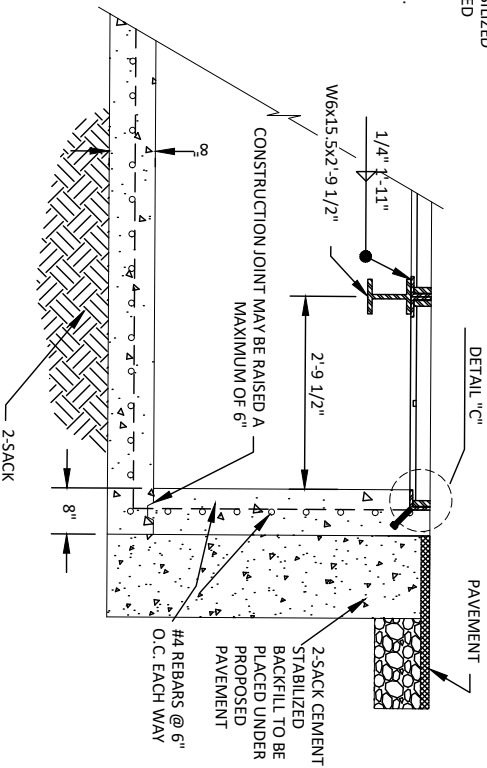

NUMBER OF GRATES	'L'
2	5'-2 1/2"
3	7'-2 1/4"
4	9'-2"
5	11'-1 3/4"

- NOTES
1. H = 20' MAXIMUM
  2. CONCRETE TO BE 3000 PSI MIN CORE TEST @ 28 DAYS.
  3. GRATE TO BE PERPENDICULAR TO TRAFFIC.
  4. STEEL GRATES (ANTI-RUST)

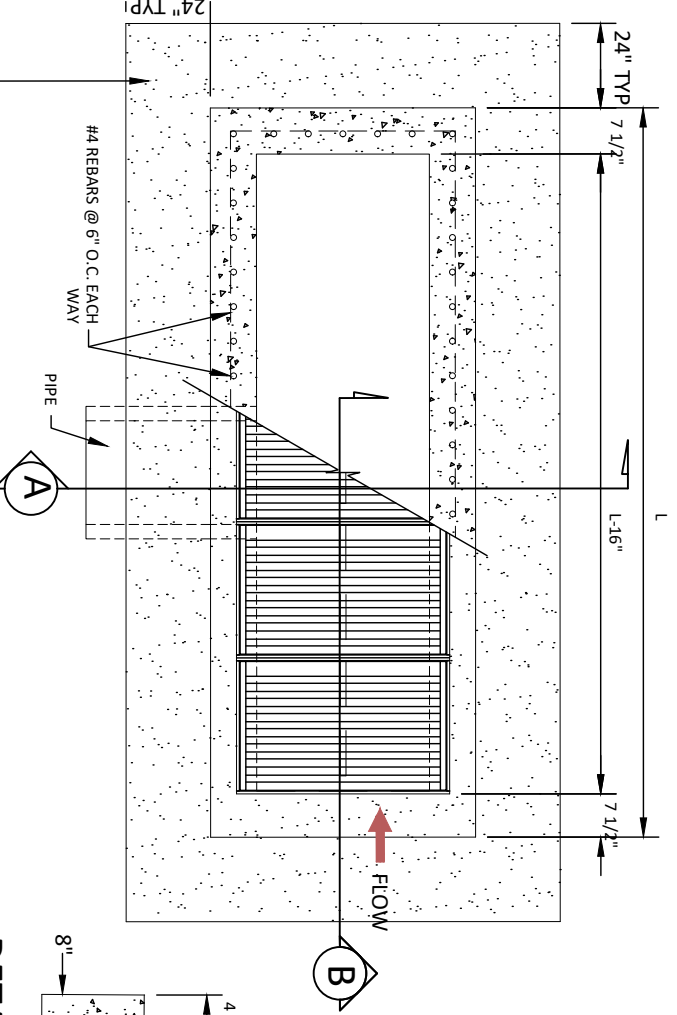

PLAN VIEW  
NTS

DETAIL "C"  
NTS

DETAIL "D"  
NTS

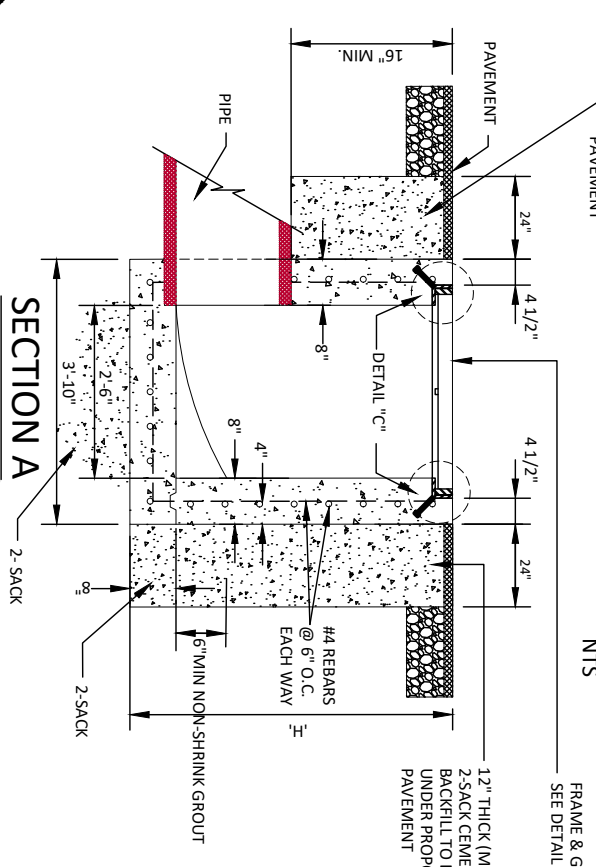
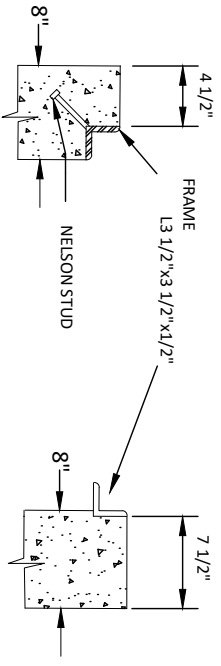

SECTION A  
NTS

SECTION B  
NTS

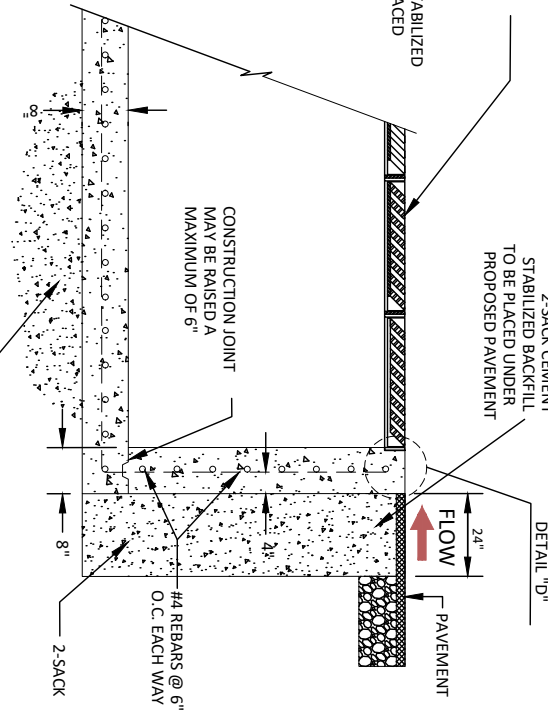

TITLE 19 - SUBDIVISION  
ORDINANCE  
STORMWATER DESIGN MANUAL  
CONSTRUCTION DETAILS

DROP INLET  
TYPE III

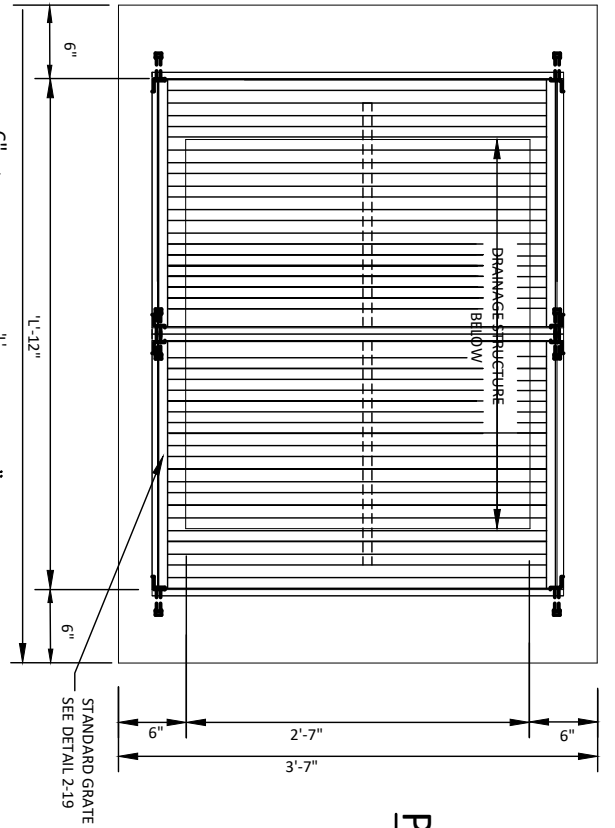

**PLAN**  
NTS

NUMBER OF GRATES	'L'
1	2'-10 3/4"
2	4'-10 1/2"
3	6'-10 1/4"
4	8'-10"
5	10'-9 3/4"

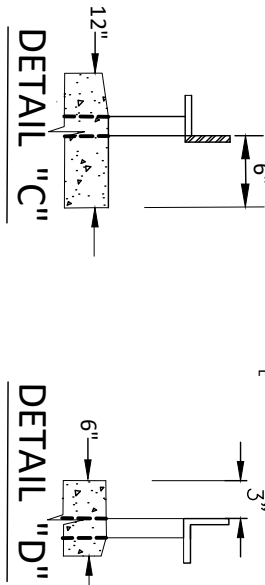

PROVIDE BOLT  
STANDARD GRATE  
SEE DETAIL 2-19

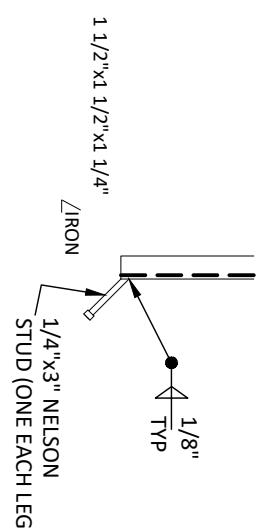

**Anchor Detail**

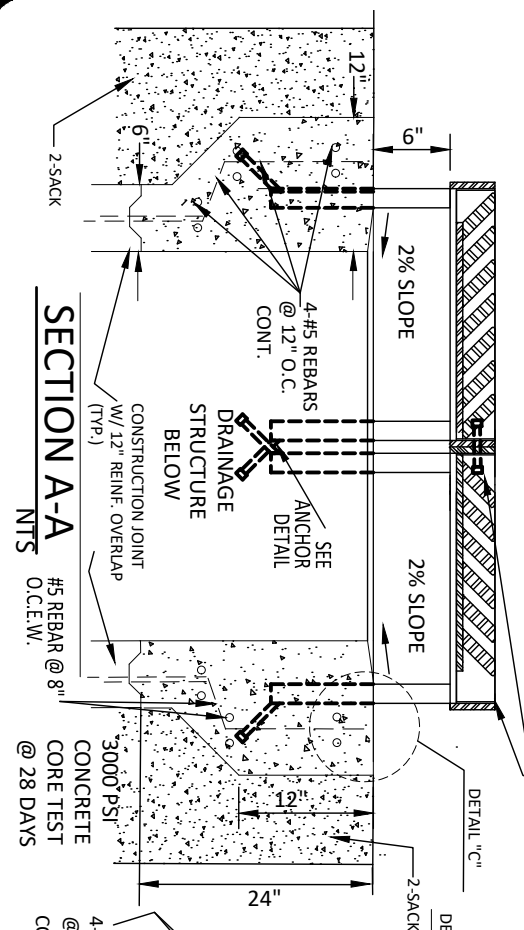

**SECTION A-A**  
NTS

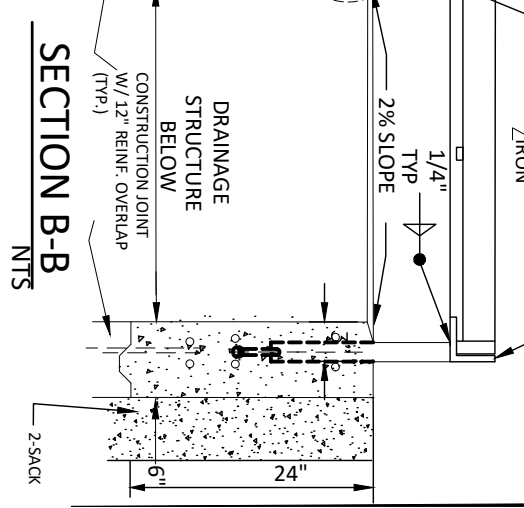

**SECTION B-B**  
NTS



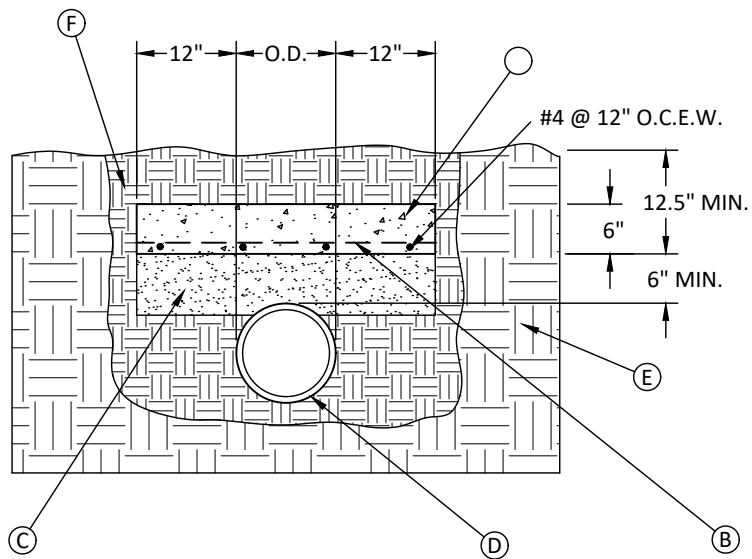

**CONCRETE CAP**  
NTS

**GENERAL NOTES:**

1. DETAIL USED WHEN STANDARD COVER CANNOT BE MET.

**CONSTRUCTION KEY NOTES:**

- A. CONCRETE CAP 3000 P.S.I. CLASS "A"
- B. USE REBAR : #4 @ 12" O.C. EACH WAY
- C. SAND CUSHION
- D. PROPOSED OR EXISTING PIPE
- E. EXISTING GROUND
- F. COMPACTED BACKFILL



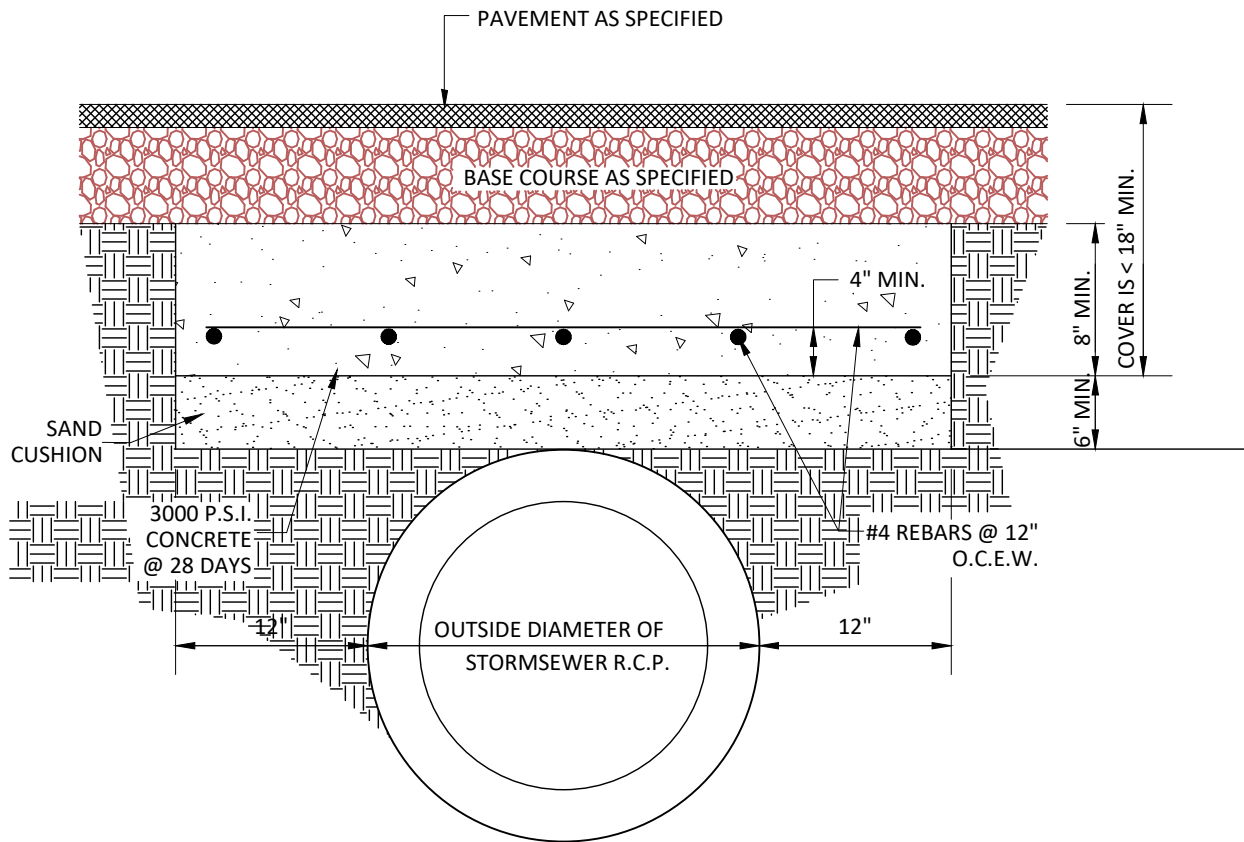

NOTE; LONGITUDINAL LENGTH OF CONCRETE CAP TO EXTEND FROM OUTSIDE FACE OF WALL OF INLET ALONG THE CENTERLINE OF PIPE TO A POINT WHERE 18" OF MIN, COVER IS OBTAINED.



TITLE 19 - SUBDIVISION  
ORDINANCE  
STORMWATER DESIGN MANUAL  
CONSTRUCTION DETAILS

Appendix 2

CONCRETE CAP  
(PAVED CONDITION)

2-25

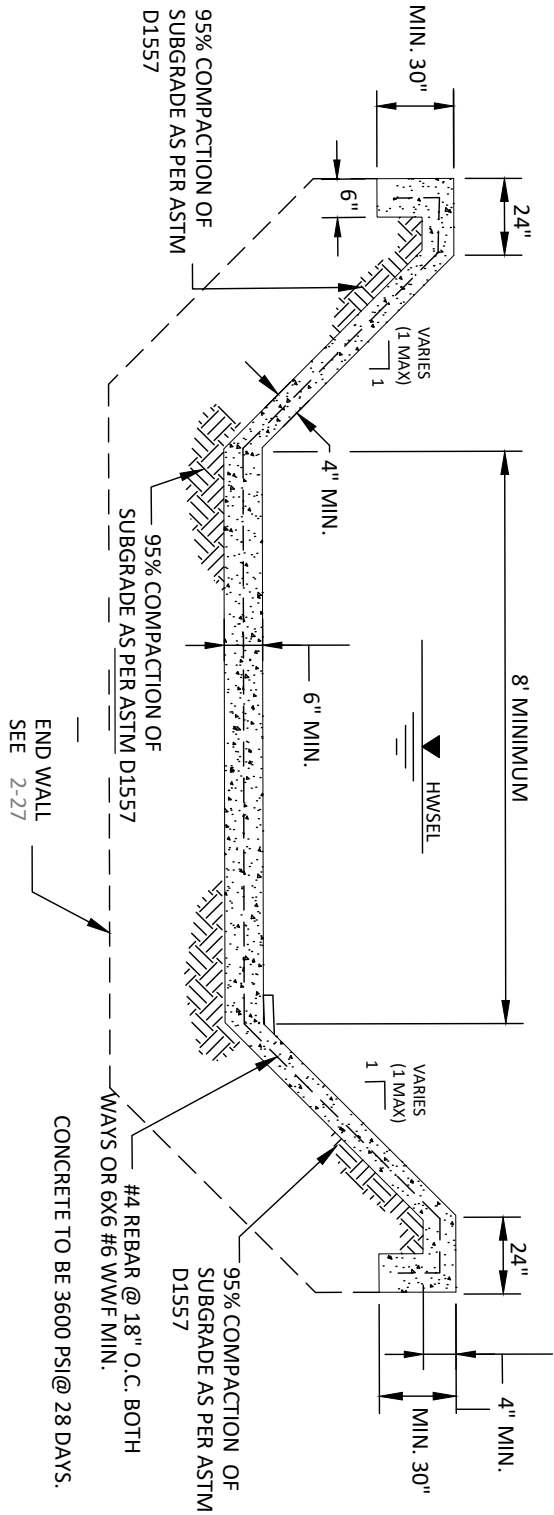

- NOTE:**
1. TYPE I SPECIFIED WHEN TOP OF CHANNEL IS EVEN WITH GROUND.
  2. CHANNEL SECTIONS SHALL BE POURED MONOLITHICALLY FROM TOP OF SLOPE TO TOP OF SLOPE
  3. SEE DRAINAGE DESIGN MANUAL, JUNE 2008 (SEC. 8.2.5) FOR REQUIRED FREEBOARD FOR SUBCRITICAL OR SUPERCRITICAL FLOWS.
  4. ENGINEER IS RESPONSIBLE FOR FINAL DESIGN AS PER SECTION \_\_\_\_\_

**ALTERNATE WING WALL DETAIL**

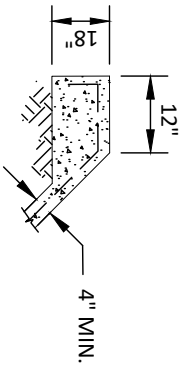

**CONCRETE CHANNEL TYPE I**

NTS

**CONCRETE CHANNEL TYPE I**

**2-26**

TITLE 19 - SUBDIVISION ORDINANCE

STORMWATER DESIGN MANUAL  
CONSTRUCTION DETAILS

Appendix 2



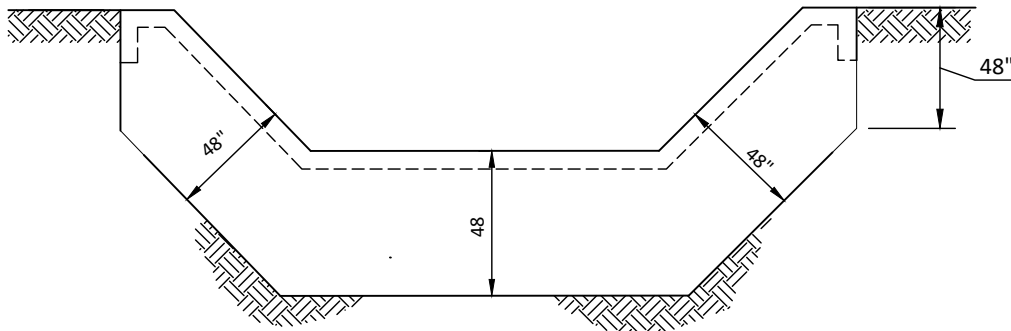

**END WALL  
ELEVATION**

NTS

**GENERAL NOTES:**

END WALLS TO BE PLACED AT BEGINNING AND END OF CONCRETE CHANNELS.

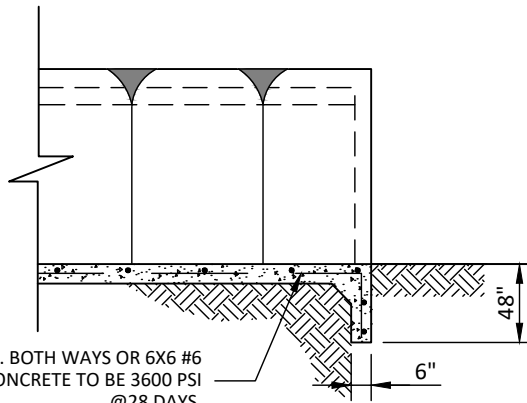

#4 REBAR @ 18" O.C. BOTH WAYS OR 6X6 #6  
WWF MIN. CONCRETE TO BE 3600 PSI  
@28 DAYS

**END WALL  
SECTIONAL VIEW**

NTS

**GENERAL NOTES:**

1. END WALLS TO BE PLACED AT BEGINNING AND END OF CONCRETE CHANNELS
2. ENGINEER IS RESPONSIBLE FOR FINAL DESIGN AS PER SECTION \_\_\_\_\_



TITLE 19 - SUBDIVISION  
ORDINANCE  
STORMWATER DESIGN MANUAL  
CONSTRUCTION DETAILS

Appendix 2

CONCRETE CHANNEL  
TYPE I END WALL  
DETAIL

2-27

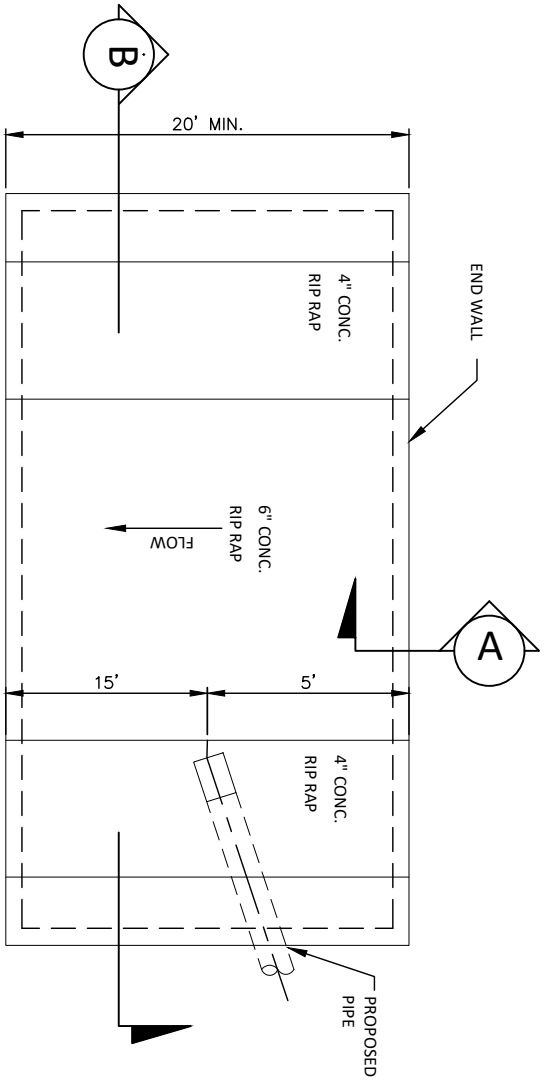

**GENERAL NOTES:**

1. CONCRETE CHANNEL INVERT MUST MATCH MAINTENANCE GRADE AND WIDTH OF CHANNEL.
2. CONCRETE CHANNEL LINING SHALL BE PLACED 10' UPSTREAM AND 25' DOWNSTREAM OF LINE DISCHARGE PIPE (48" MAXIMUM) WHERE THE PIPE DAYLIGHTS.
4. ALL CONCRETE TO BE 3600PSI @ 28 DAYS. CHANNEL SECTIONS SHOULD BE POURED MONOLITHICALLY FROM TOP SLOPE TO TOP OF SLOPE.
6. PIPE SHALL BE AT A 45° OR LESS FROM THE CENTER LINE OF THE CHANNEL.

**CONSTRUCTION KEY NOTES:**

1. #4 REBAR 18" O.C. BOTH WAYS

**PLAN VIEW**  
NTS

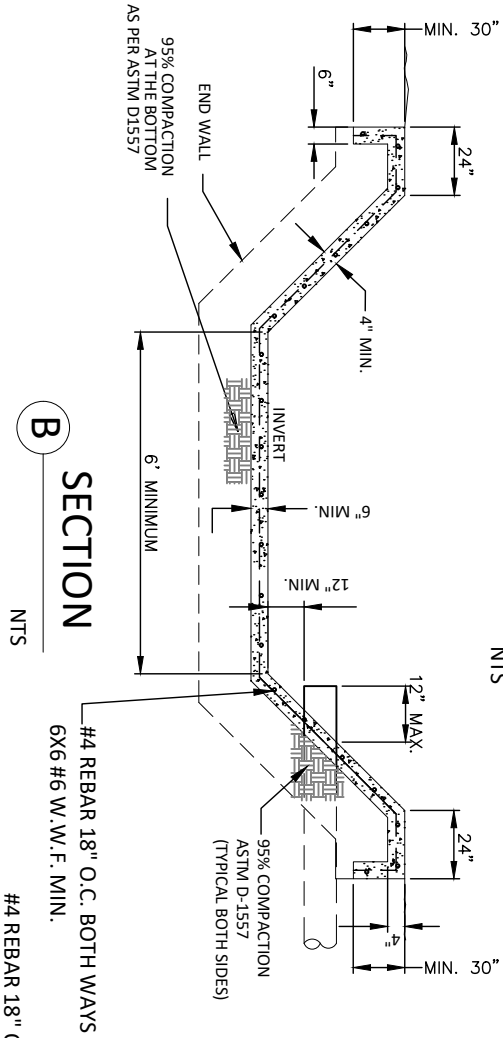

**SECTION**  
NTS

NTS

95% COMPACTION AT THE BOTTOM AS PER ASTM D1557

6" MINIMUM

12" MIN.

6" MIN.

4" MIN.

24"

MIN. 30"

12" MAX.

95% COMPACTION ASTM D-1557 (TYPICAL BOTH SIDES)

#4 REBAR 18" O.C. BOTH WAYS

6X6 #6 W.W.F. MIN.

#4 REBAR 18" O.C. BOTH WAYS

**SECTION**  
NTS

NTS

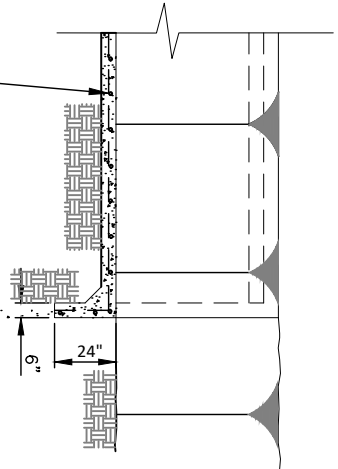

**SECTION**  
NTS

NTS

**CHANNEL LINING AT PIPE DISCHARGE**





**GENERAL NOTES:**

MAX. EXPANSION JOINT SPACING @ 100 FEET O.C.  
ALONG C.L. OF CHANNEL.

POURED EXPANSION JOINT SEALANT MATERIAL

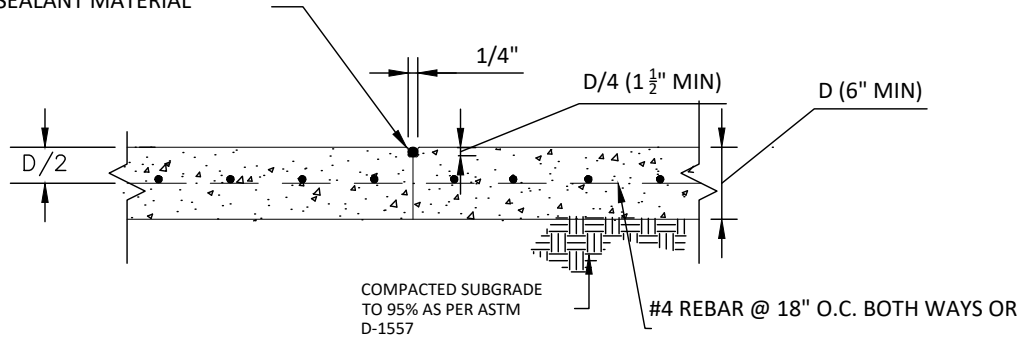

CONTRACTION JOINT AT 25' O.C.  
NTS

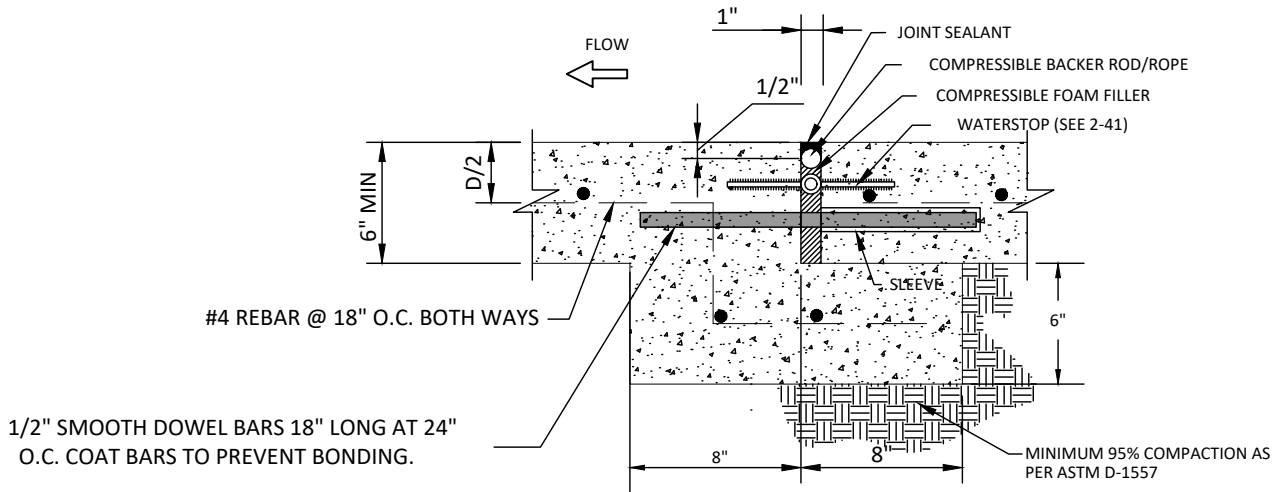

EXPANSION JOINT  
NTS



TITLE 19 - SUBDIVISION  
ORDINANCE  
STORMWATER DESIGN MANUAL  
CONSTRUCTION DETAILS

Appendix 2

CONCRETE JOINTS

2-29

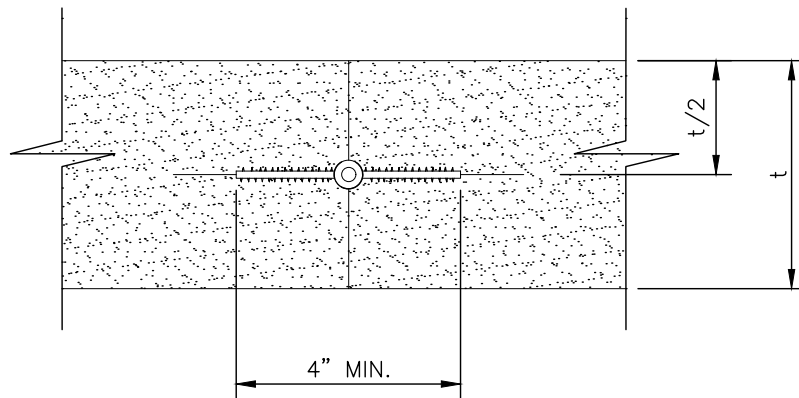

NTS

NOTE:

WATERSTOP SHALL BE GREENSTREAK PVC MATERIAL,  
SPECIFICATIONS GRADE, 6" X 1/8" AND SERRATED WITH  
CENTERBULB OR APPROVED EQUAL.



TITLE 19 - SUBDIVISION  
ORDINANCE  
STORMWATER DESIGN MANUAL  
CONSTRUCTION DETAILS

Appendix 2

WATERSTOP DETAIL

2-30

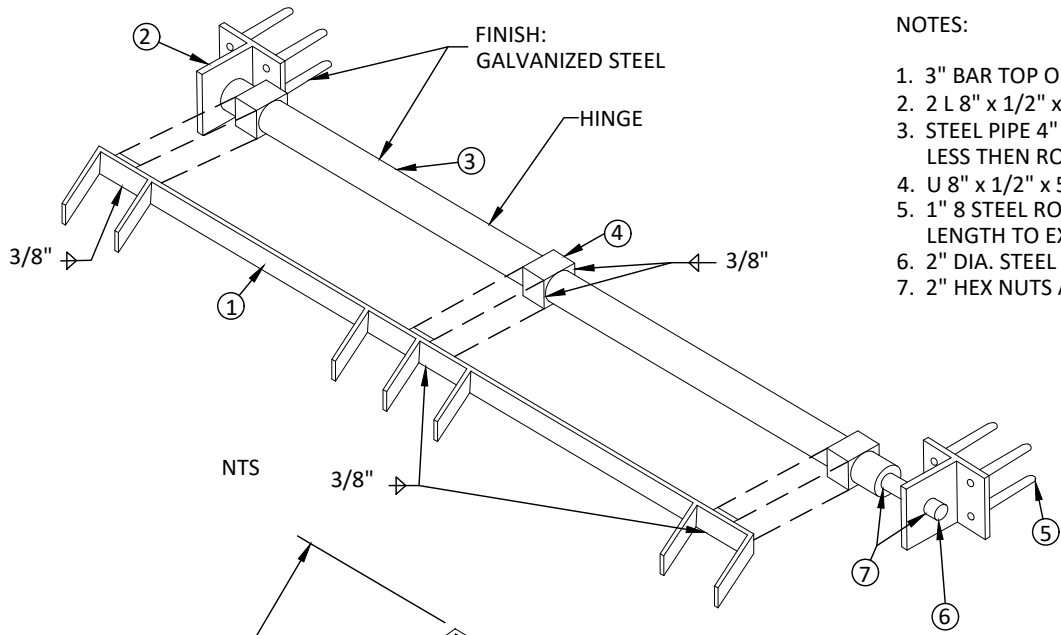

- NOTES:
1. 3" BAR TOP OF RACK.
  2. 2 L 8" x 1/2" x 5"
  3. STEEL PIPE 4" O.D. 2-1/2" I.D. LENGTH 6" LESS THEN ROD
  4. U 8" x 1/2" x 5" x 3"
  5. 1" 8 STEEL RODS THREADED BOTH ENDS LENGTH TO EXTEND THROUGH HEADWALL.
  6. 2" DIA. STEEL ROD THREAD BOTH ENDS.
  7. 2" HEX NUTS AND WASHERS.

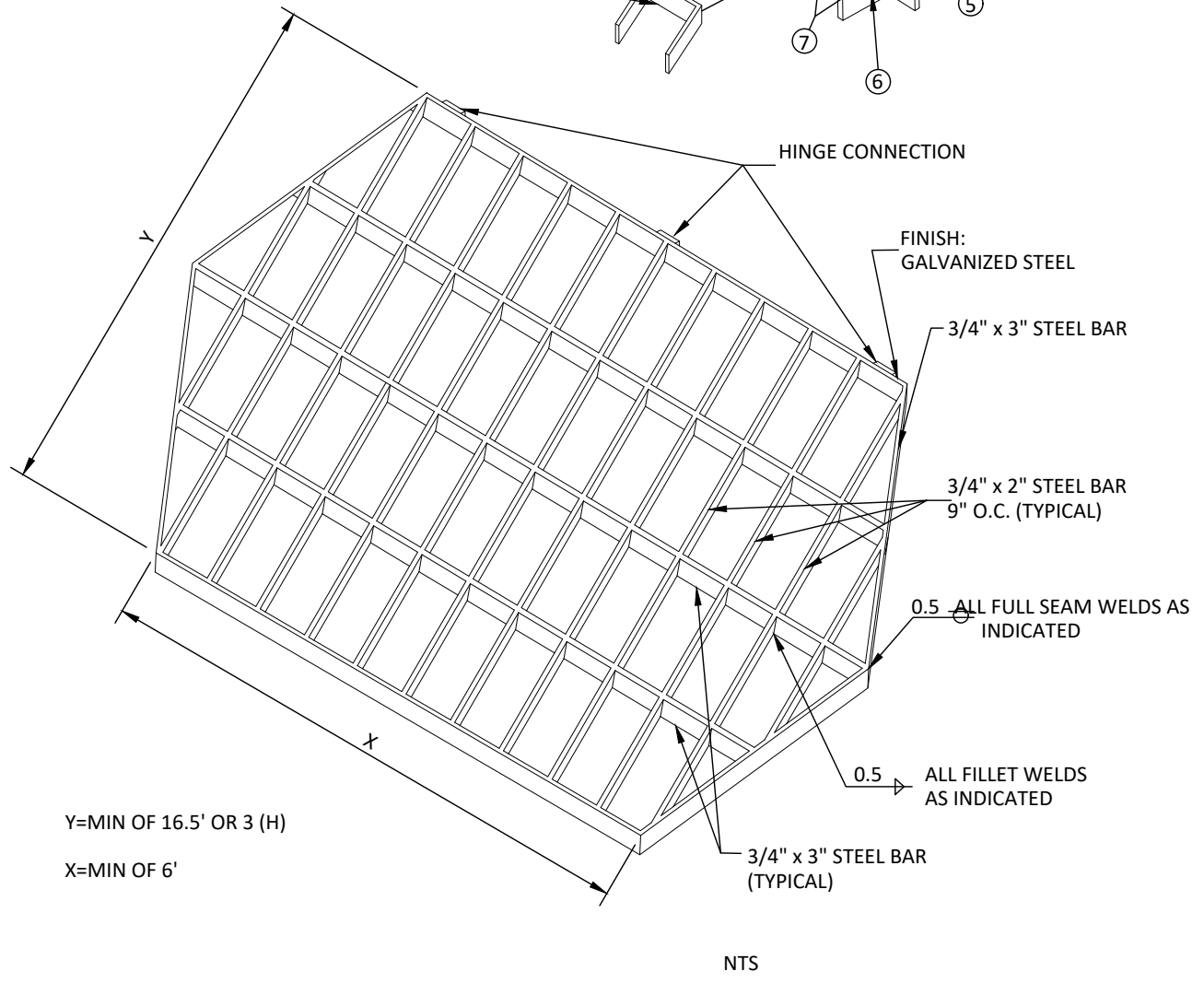

Y=MIN OF 16.5' OR 3 (H)  
 X=MIN OF 6'



TITLE 19 - SUBDIVISION  
 ORDINANCE  
 STORMWATER DESIGN MANUAL  
 CONSTRUCTION DETAILS

Appendix 2

DEBRIS TRAP/SAFETY  
 GRATE

2-31



NTS

GENERAL NOTES:

1. SIGN MATERIAL TO BE 16 GAUGE GALVANIZED SHEET METAL.
2. TOP PART OF SIGN SHALL SHOW BLACK LETTERS ON A WHITE BACKGROUND.
3. BOTTOM PART OF SIGN SHALL SHOW WHITE LETTERS ON A BLACK BACKGROUND.



TITLE 19 - SUBDIVISION  
 ORDINANCE  
 STORMWATER DESIGN MANUAL  
 CONSTRUCTION DETAILS

Appendix 2

**NO TRESPASSING  
 WARNING SIGN**

**2-32**

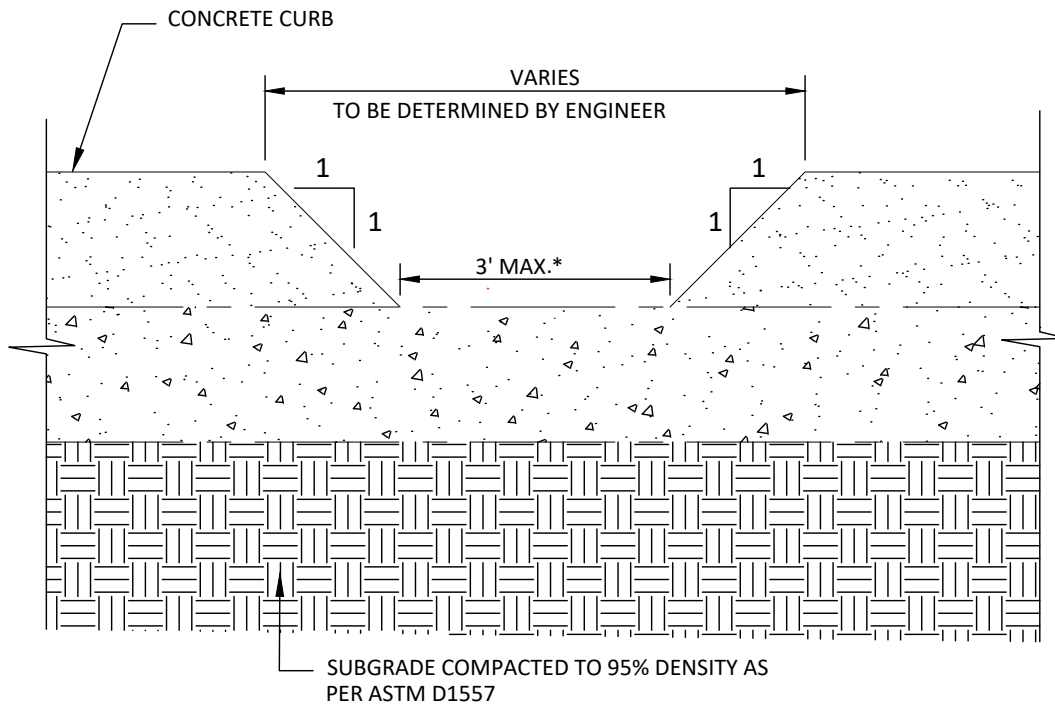

## CURB OPENING FOR DRAINAGE

SCALE: N.T.S.

**\* NOTE:**

3' MAX, IF PERMISSION IS GRANTED  
FOR A WIDER OPENING PROTECTIVE  
MEASURES SUCH AS PIPE BOLLARDS  
OR GUARDRAIL SHALL BE USED.



TITLE 19 - SUBDIVISION  
ORDINANCE

STORMWATER DESIGN MANUAL  
CONSTRUCTION DETAILS

Appendix 2

CURB OPENING FOR  
DRAINAGE

2-33

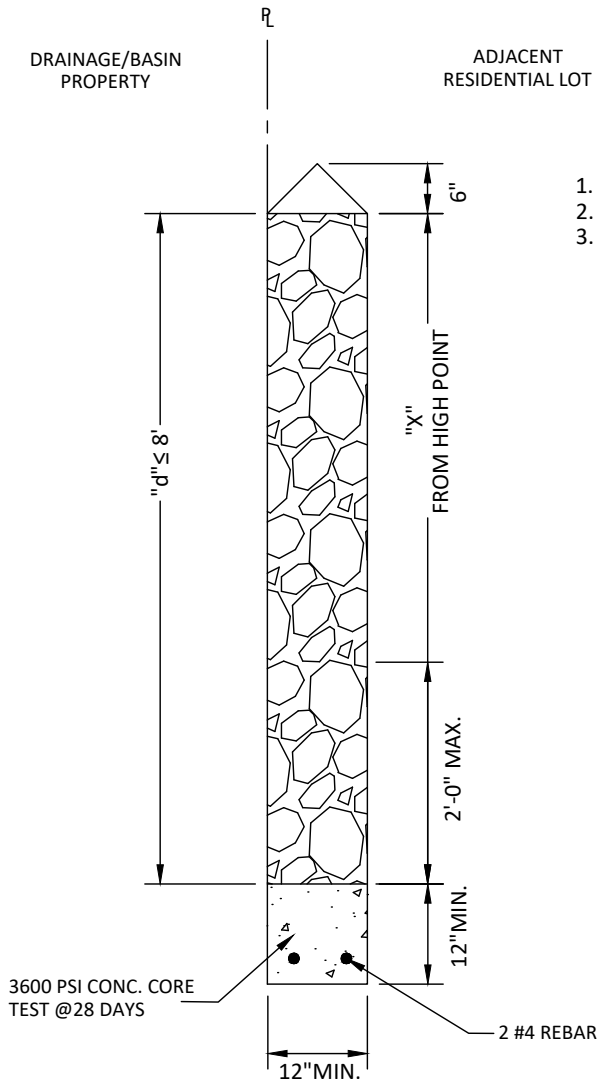

- "X"
1. 6' MAX. ALONG REAR & SIDE YARDS.
  2. 3'-6" MAX. ALONG FRONT YARDS.
  3. 6' HIGH @DRAINAGE AND BASINS.

3600 PSI CONC. CORE  
TEST @28 DAYS

2 #4 REBAR

NTS

**GENERAL NOTES:**

1. STONE FOR ROCKWALL SHALL BE AS NEARLY UNIFORM IN SECTIONS AS IS PRACTICABLE. THE STONE SHALL BE DENSE AND RESISTANT TO AIR AND WATER.
2. MORTAR SHALL BE TYPE "S" 1800 PSI AS PER ASTM C270.
3. MASONRY WALLS OVER SIX (6) FEET IN HEIGHT AND THOSE USED FOR EARTH RETENTION OVER TWO (2) FEET SHALL BE DESIGNED AS STRUCTURAL WALLS.
4. ROCKWALLS SHOULD BE CONSTRUCTED OUTSIDE DRAINAGE/BASIN AREA.
5. ROCKWALL MORTAR JOINTS SHALL NOT EXCEED TWO (2) INCHES.
6. ALL STONE SHALL BE THOROUGHLY SOAKED BEFORE BEING PLACED.
7. NO RIVER ROCK SHALL BE ALLOWED FOR ROCKWALLS.

NOTE:  
BACKFILL MATERIAL TO BE  
COMPACTED TO 95% STANDARD  
PROCTOR DENSITY



TITLE 19 - SUBDIVISION  
ORDINANCE  
STORMWATER DESIGN MANUAL  
CONSTRUCTION DETAILS

Appendix 2

ROCKWALL DESIGN

2-34

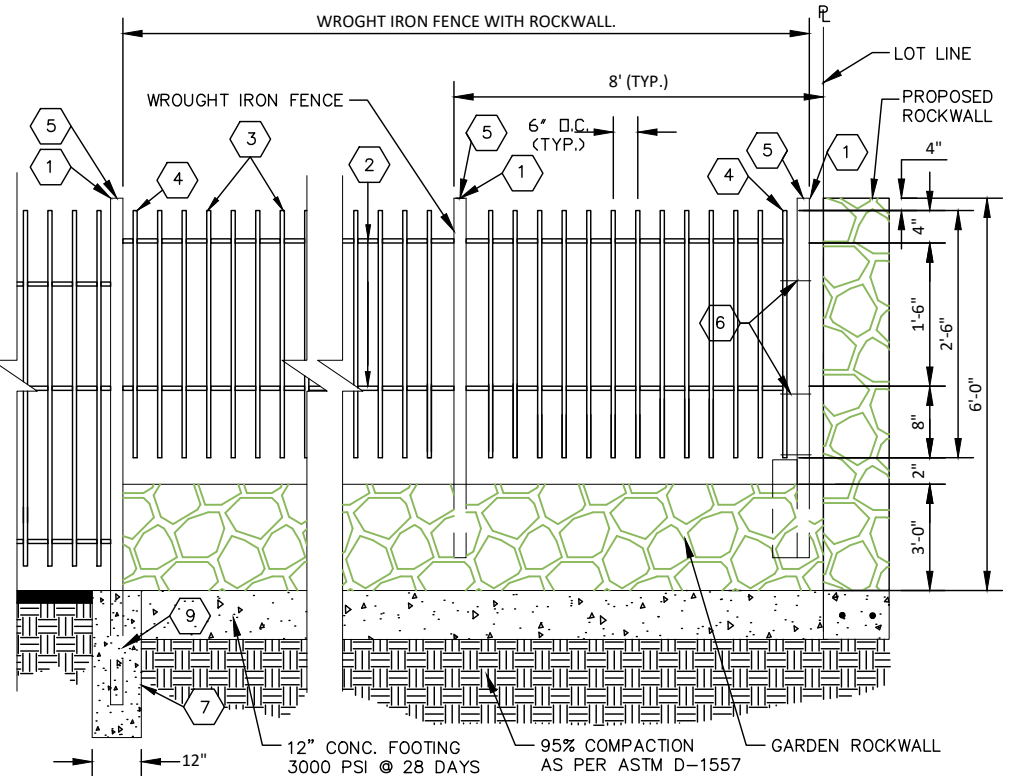
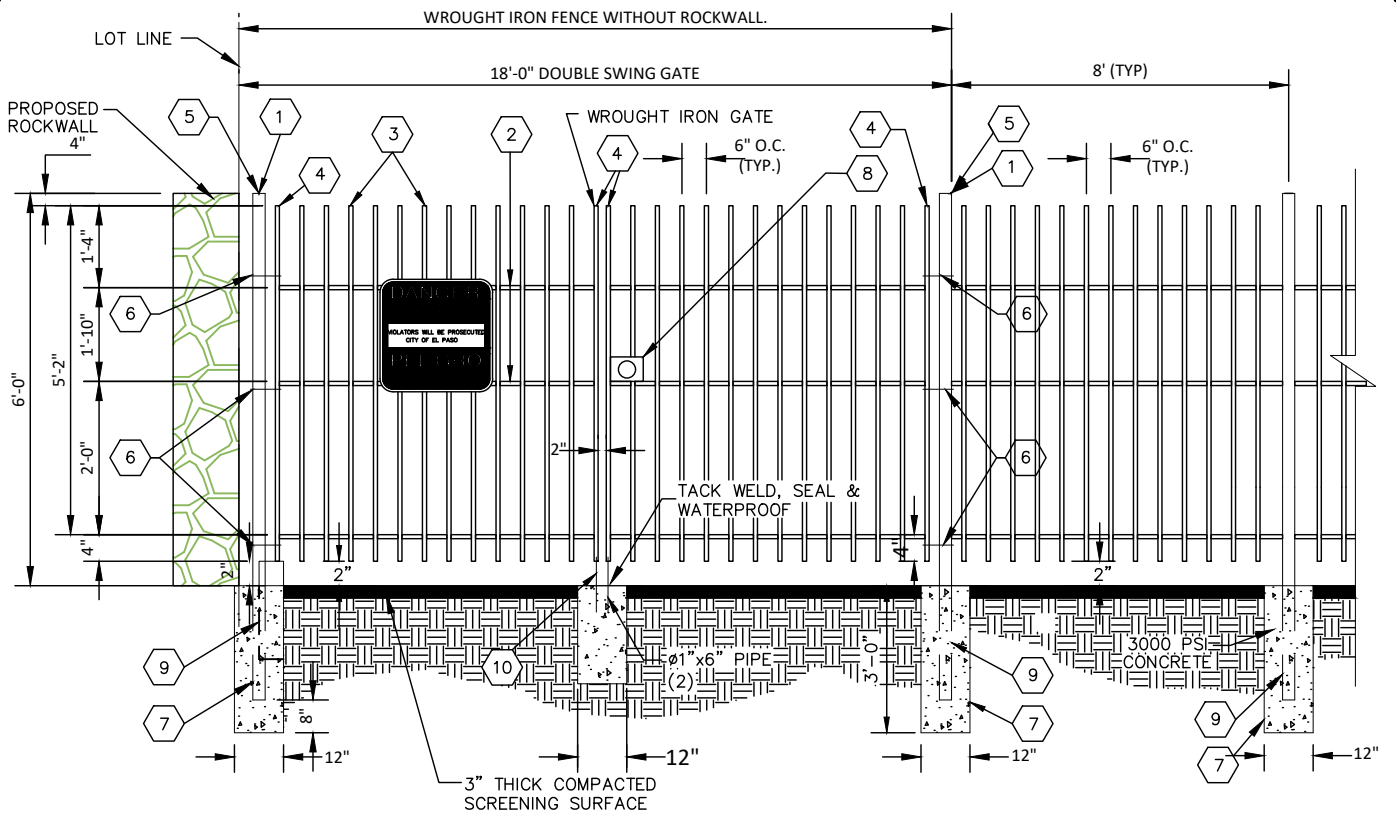

**KEY NOTES**

- 1 3" x 3" x 3/16" SQUARE STEEL TUBING
- 2 2" x 1" x 14 GA. RECTANGULAR STEEL TUBING
- 3 1 1/2" x 1/2" x 16 GA. RECTANGULAR STEEL TUBING
- 4 2" x 1" x 10 GA. RECTANGULAR STEEL TUBING
- 5 FLAT TOP POLYVINYL CAP
- 6 BOLT HOOK AND STRAP HINGE
- 7 1' x 3' DEEP 3600 PSI CONCRETE POST FOOTING
- 8 DOUBLE GATE HEAVY DUTY INDUSTRIAL LATCH W/PAD LOCK
- 9 5"x5"x3/8" SQUARE STEEL SLEEVE W/7"x7"x3/8" STEEL BASE PLATE
- 10 CANE BOLT LATCH W/KEEPER 5-8" x 18" LONG (2 REQUIRED)

N.T.S.



TITLE 19 - SUBDIVISION  
ORDINANCE  
STORMWATER DESIGN MANUAL  
CONSTRUCTION DETAILS

WROUGHT IRON  
FENCE AND GATE  
DETAIL

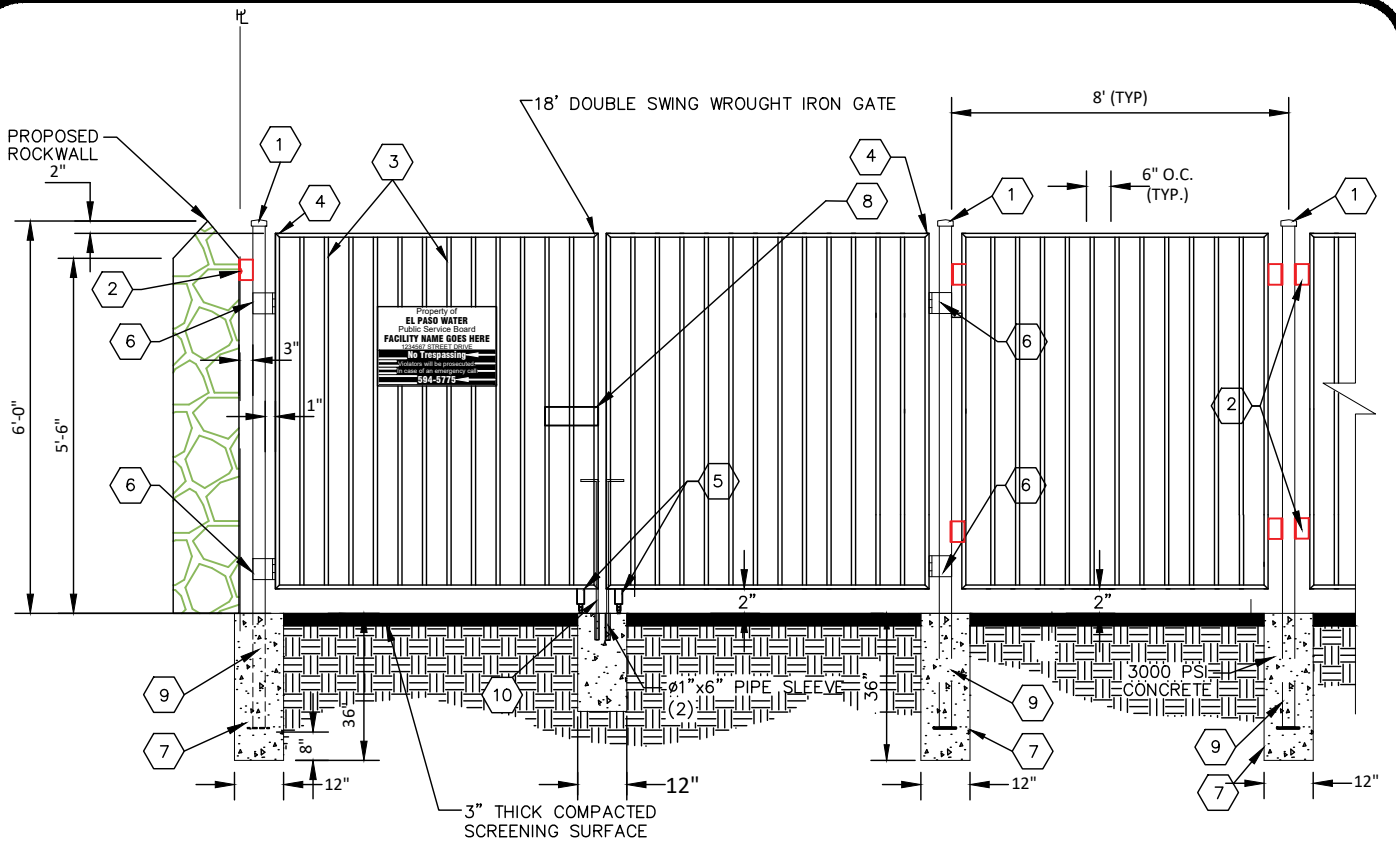

- KEY NOTES**
- 1 3" SQ. x 3/16" THK. STEEL POST W/ WELDED METAL CAP.
  - 2 3" x 3" x 3 1/2" ANGLE IRON WELDED TO POST & BOLTED TO WALL
  - 3 1" SQ. x 10 GA. STEEL TUBING.
  - 4 2 1/2" SQ. x 10 GA. STEEL TUBING FRAME.
  - 5 4" DIAMETER WHEELS
  - 6 BOLT HOOK & BARREL HINGE.
  - 7 1' x 3' DEEP 3600 PSI CONCRETE POST FOOTING.
  - 8 DOUBLE GATE HEAVY DUTY INDUSTRIAL LATCH W/PAD LOCK
  - 9 7" x 7" x 3/8" THK. STEEL BASE PLATE WELDED TO POST.
  - 10 CANE BOLT LATCH W/KEEPER 5-8" x 18" LONG (2 REQUIRED)

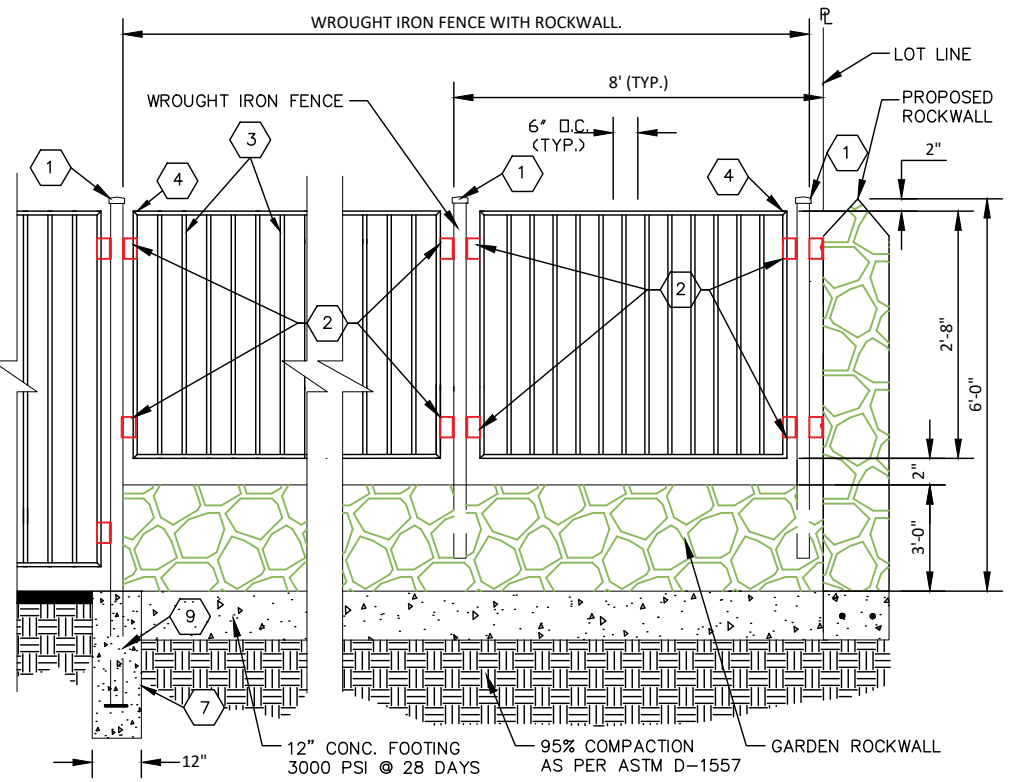

N T S



TITLE 19 - SUBDIVISION  
ORDINANCE

STORMWATER DESIGN MANUAL  
CONSTRUCTION DETAILS

WROUGHT IRON FENCE  
AND GATE DETAIL



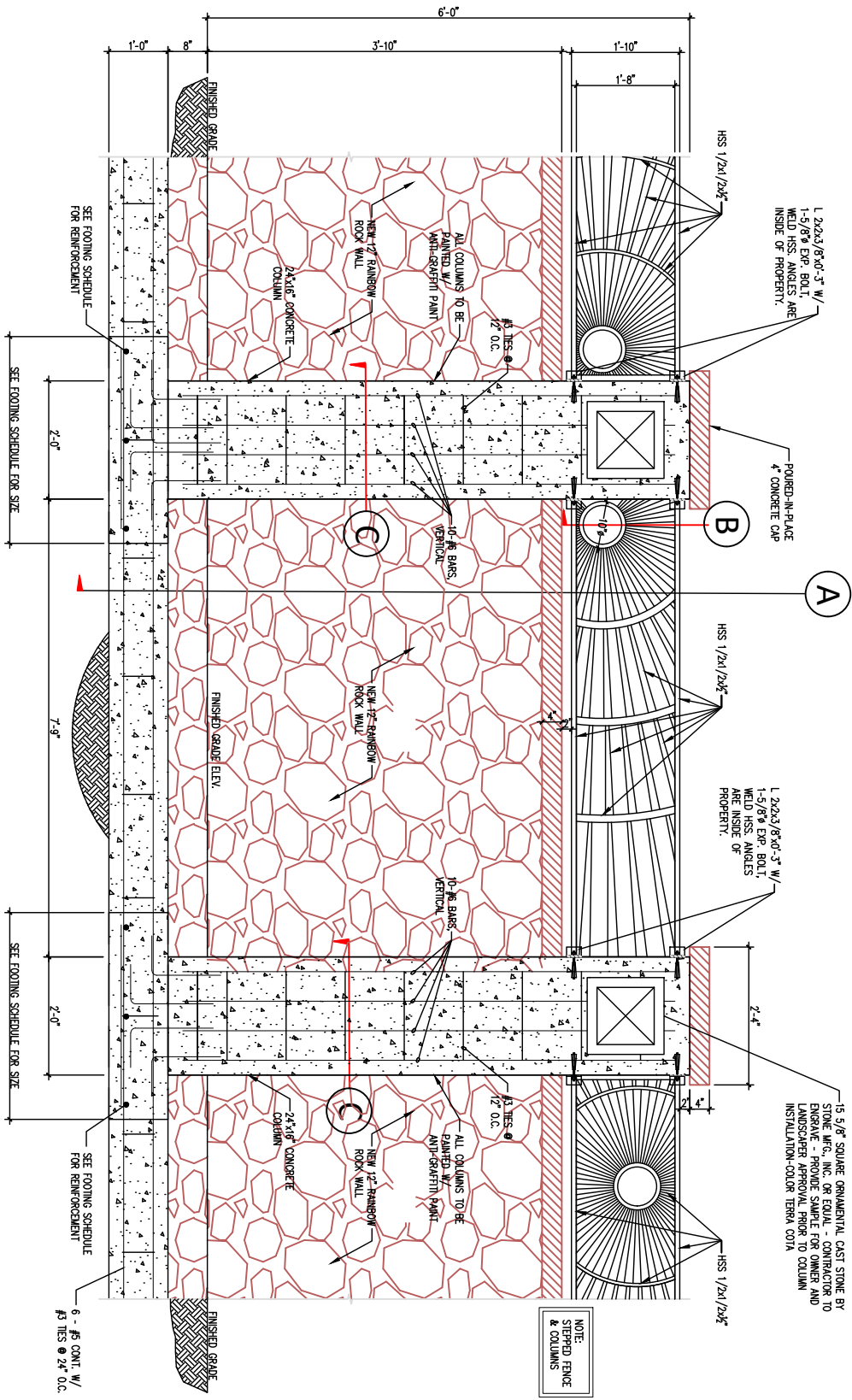

NOTE:  
ALL FOUNDATIONS TO BE ECCENTRIC & STAY INSIDE THE PROPERTY.

NOTE:  
STEPPED FENCE & COLUMNS

15 5/8" SQUARE ORNAMENTAL CAST STONE BY STONE MFG. INC. OR EQUAL - CONTRACTOR TO ENGAGE - PROVIDE SAMPLE FOR OWNER AND LANDSCAPER APPROVAL PRIOR TO COLUMN INSTALLATION-COLOR TERRA COTTA



TITLE 19 - SUBDIVISION ORDINANCE  
STORMWATER DESIGN MANUAL  
CONSTRUCTION DETAILS

WROUGHT IRON FENCE AND GATE  
DETAIL

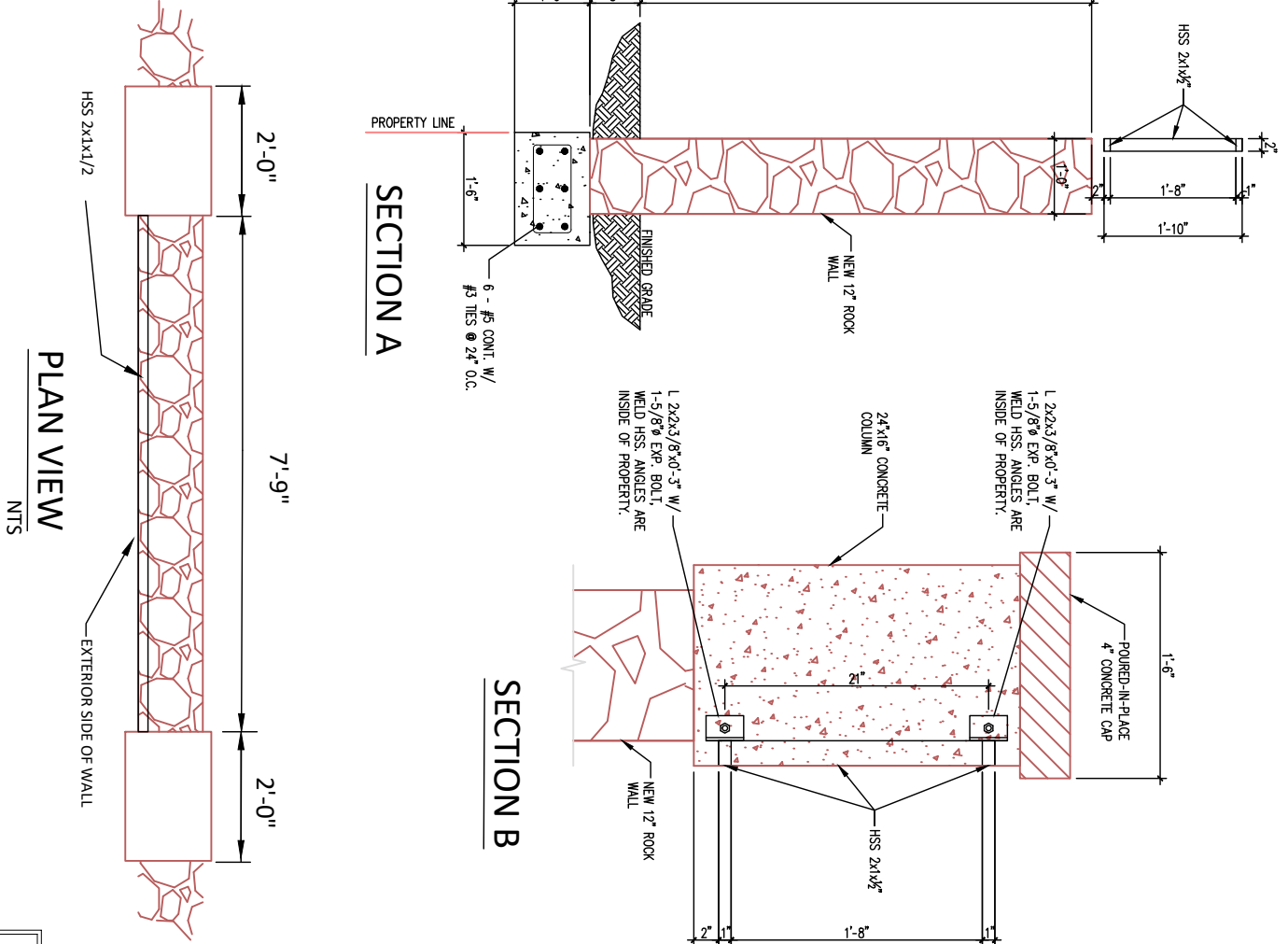

**SECTION A**

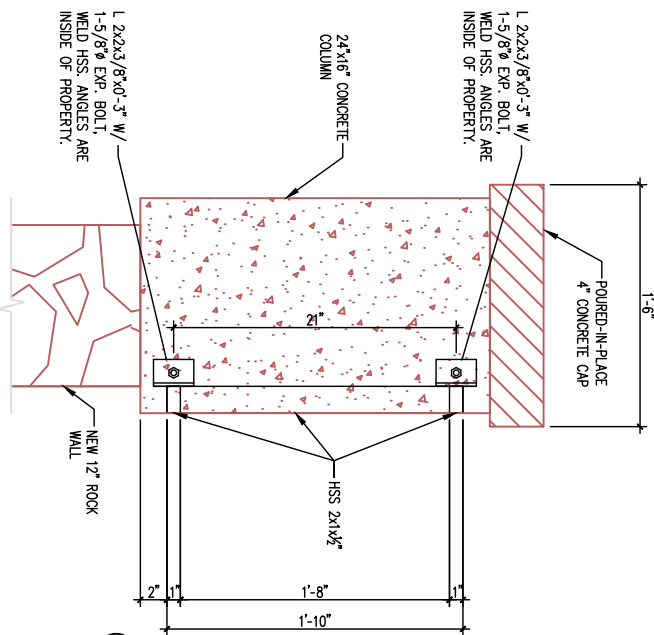

**SECTION B**

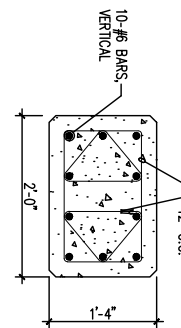

**SECTION C**

NOTE:  
ALL COLUMNS TO BE PAINTED  
W/ ANTI-GRAFFITI PAINT.

NOTE:  
START ON ONE SIDE OF THE  
FENCE & CONTINUE

**PANEL PROGRESSION**  
N.T.S.

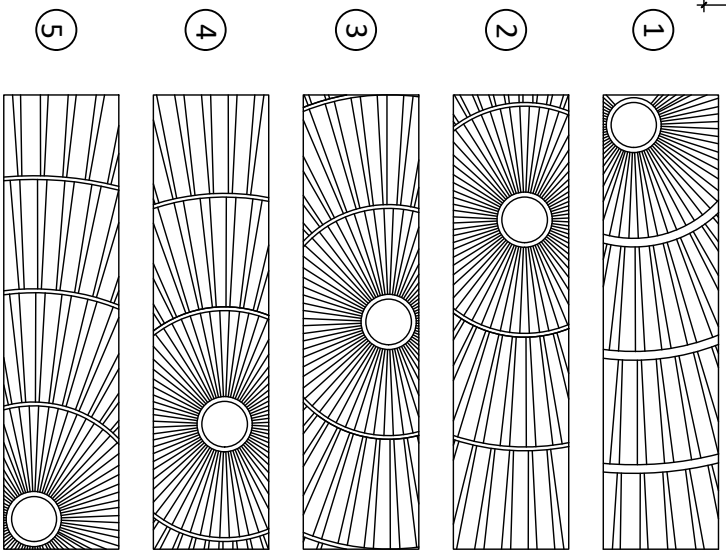

TITLE 19 - SUBDIVISION  
ORDINANCE  
STORMWATER DESIGN MANUAL  
CONSTRUCTION DETAILS

Appendix 2

**WROUGHT IRON  
FENCE AND GATE  
DETAIL**

**2-38**

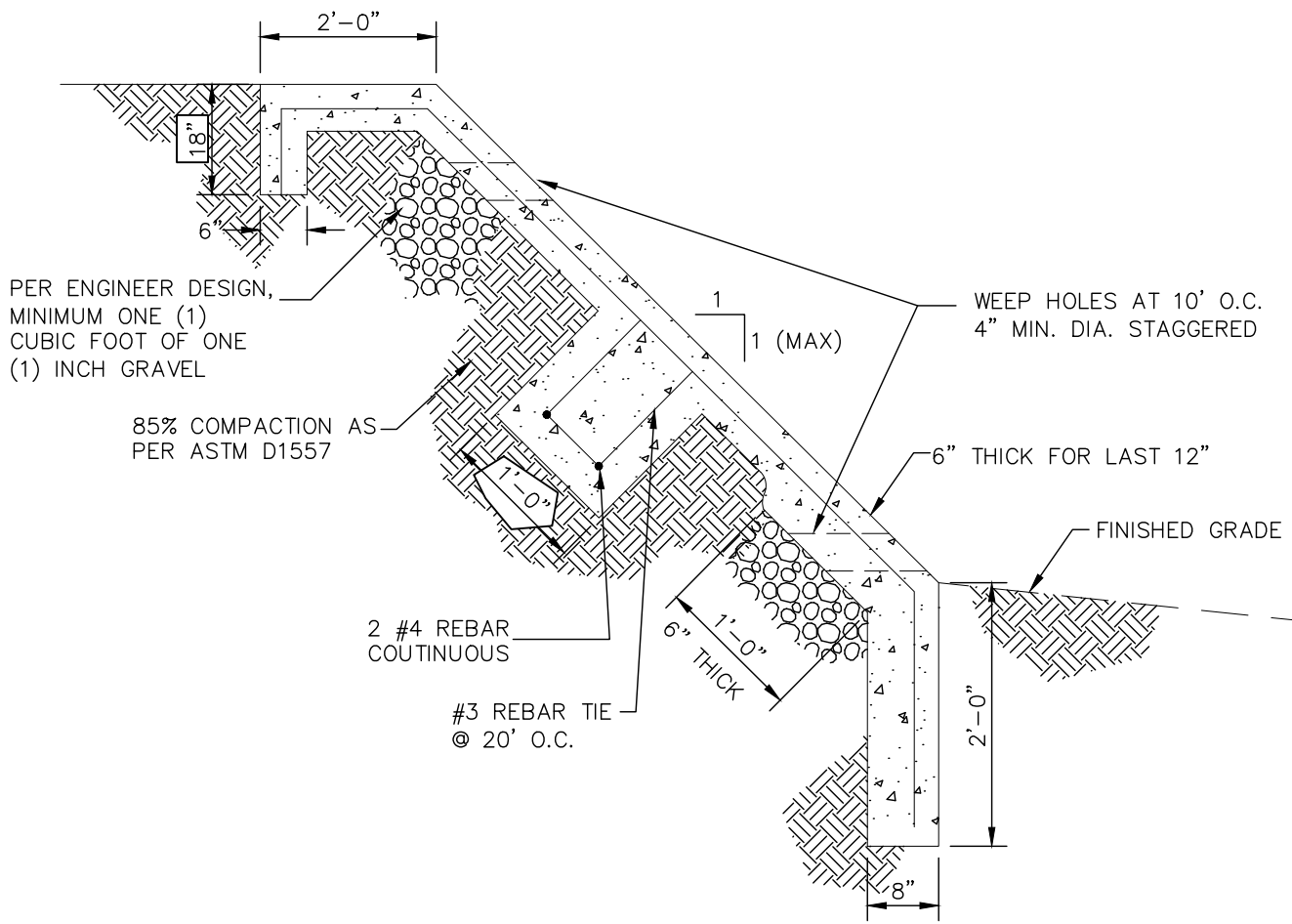

**CONCRETE SIDE SLOPE PROTECTION DETAIL**

SCALE: N.T.S.

NOTES:

1. CONCRETE SIDE SLOPE PROTECTION SHALL BE PLACED ON EMBANKMENTS OR SLOPES WHERE REQUIRED BY THE CITY ENGINEER FOR EROSION PROTECTION, EXCEPT FOR PONDING AREAS. (REFER TO CHAPTER 3)
2. CONCRETE SIDE SLOPE PROTECTION SHALL BE A MINIMUM OF 4" CONCRETE.
3. CONCRETE TO BE 3000 PSI WITH REBAR SHOWN ON DETAIL. FINAL REBAR PER ENGINEER DESIGN.
4. FOR SLOPES GREATER THAN 3:1 OR VERTICAL HEIGHT OF MORE THAN SIX(6) FEET, THE CONCRETE SIDE SLOPE PROTECTION SHALL BE DESIGNED BY A PROFESSIONAL ENGINEER.
5. PROVIDE ONE (1) INCH EXPANSION JOINT AT EVERY FIFTY (50) FEET WITH #6 DOWELS AT 18 INCHES O.C. INCLUDE JOINT SEALANT
6. PROVIDE DUMMY JOINTS AT TEN (10) FEET O.C.



TITLE 19 - SUBDIVISION  
ORDINANCE  
**STORMWATER DESIGN MANUAL**  
CONSTRUCTION DETAILS

Appendix 2

**CONCRETE SLOPE  
PROTECTION**

**2-39**

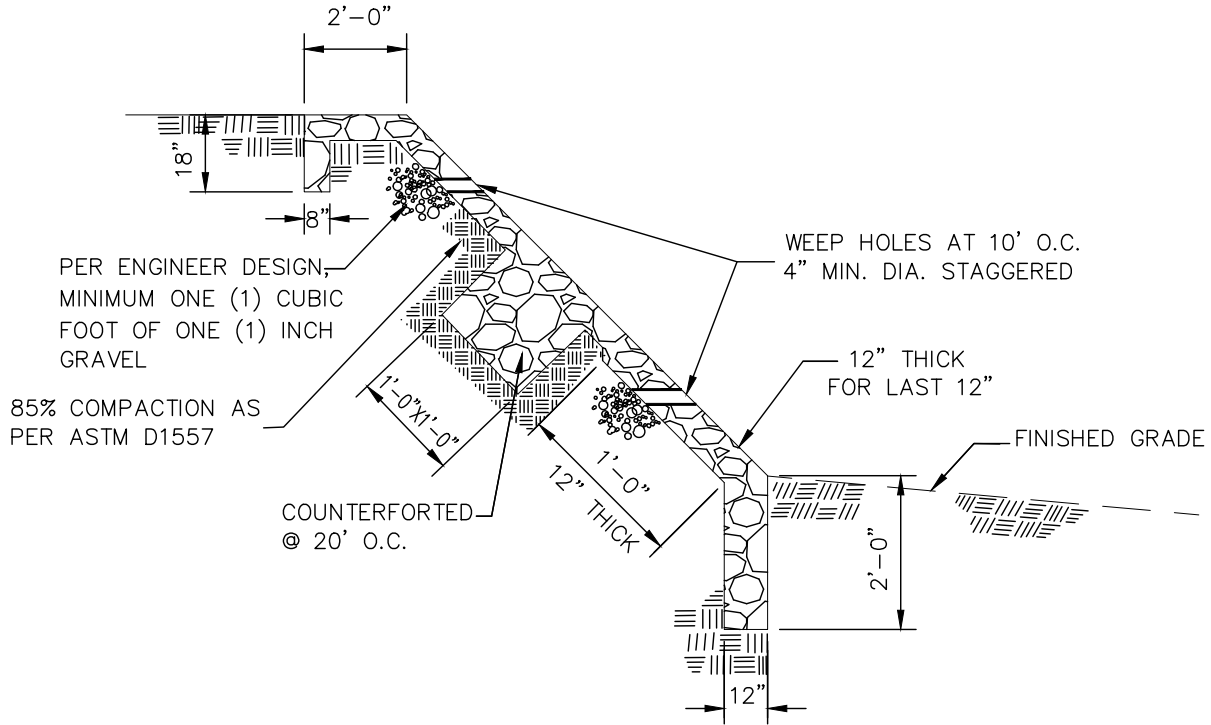

## MORTAR FILLED ROCK RIP-RAP DETAIL

NTS

### NOTES:

1. MORTAR FILLED ROCK RIP-RAP SHALL BE PLACED ON EMBANKMENTS OR SLOPES WHERE REQUIRED BY THE CITY ENGINEER FOR EROSION PROTECTION, EXCEPT FOR PONDING AREAS. (SEE SECTION 2)
2. MORTAR FILLED ROCK RIP-RAP SHALL BE A MINIMUM OF 8" MORTARED ROCK.
3. STONE FOR ROCK RIP RAP SHALL BE AS NEARLY UNIFORM IN SECTION AS IS PRACTICABLE. STONE SHALL BE QUARRIED; FRACTURED RIVERROCK SHALL NOT BE PERMITTED.
4. MORTAR FOR ROCK RIP-RAP SHALL BE TYPE S, 1800 P.S.I. AS PER ASTM C270.
5. FOR SLOPES GREATER THAN 3:1 OR VERTICAL HEIGHT OF MORE THAN SIX (6) FEET, THE MORTAR FILLED RIP RAP SHALL BE DESIGNED BY A PROFESSIONAL ENGINEER.
6. MORTAR JOINTS SHALL NOT EXCEED 2 INCHES.



TITLE 19 - SUBDIVISION  
ORDINANCE  
**STORMWATER DESIGN MANUAL**  
CONSTRUCTION DETAILS

Appendix 2

**MORTAR FILLED  
ROCK RIP RAP**

2-40

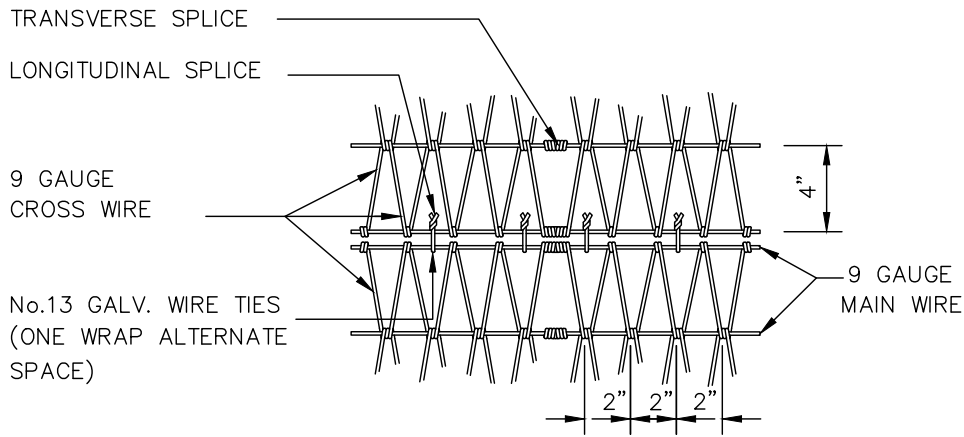

## WIRE FABRIC AND SPLICE DETAIL (FOR NON-COHESIVE SOIL) N.T.S.

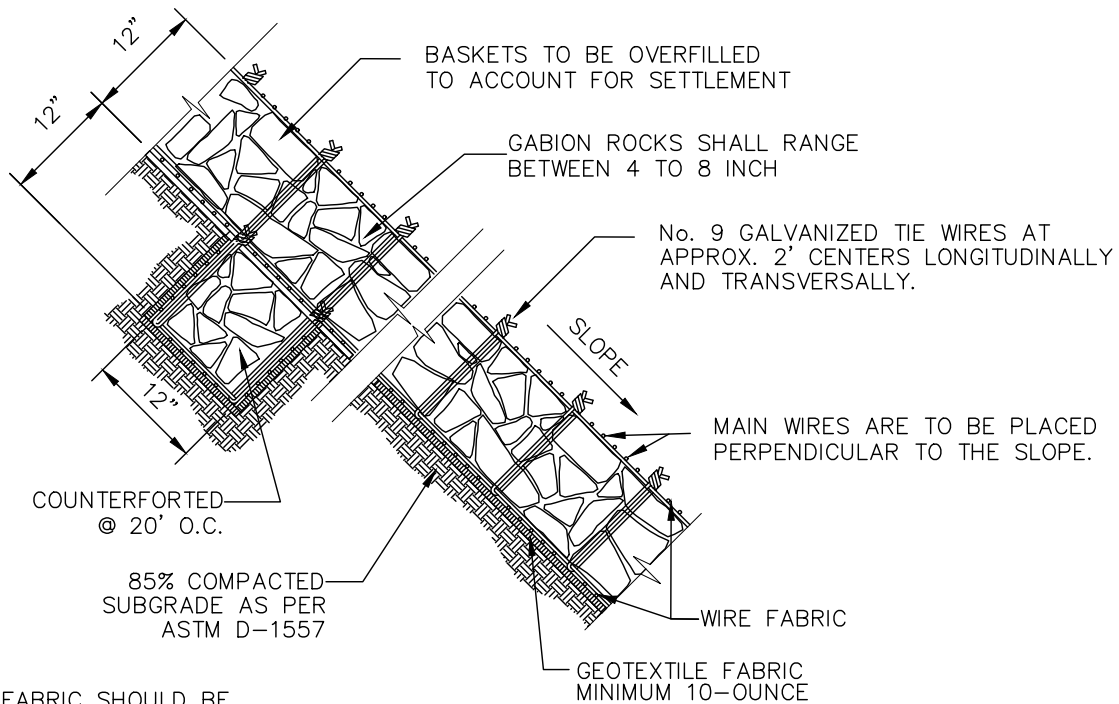

### TYPICAL SECTION

## WIRE WRAPPED RIP-RAP DETAIL

N.T.S.

NOTE:  
GEOTEXTILE FABRIC SHOULD BE EMBEDDED IN GROUND ABOVE AND BELOW WIRE WRAPPED RIP SECTIONS TO PREVENT EROSION. EMBEDDED DEPTHS SHALL BE PER GEOTECHNICAL AND/OR PROFESSIONAL ENGINEER DESIGN



TITLE 19 - SUBDIVISION  
ORDINANCE

STORMWATER DESIGN MANUAL  
CONSTRUCTION DETAILS

Appendix 2

GABION MATTRESS  
RIP RAP

2-41

# APPENDIX 3

STREET CROSS SECTIONS

STORMWATER DESIGN MANUAL



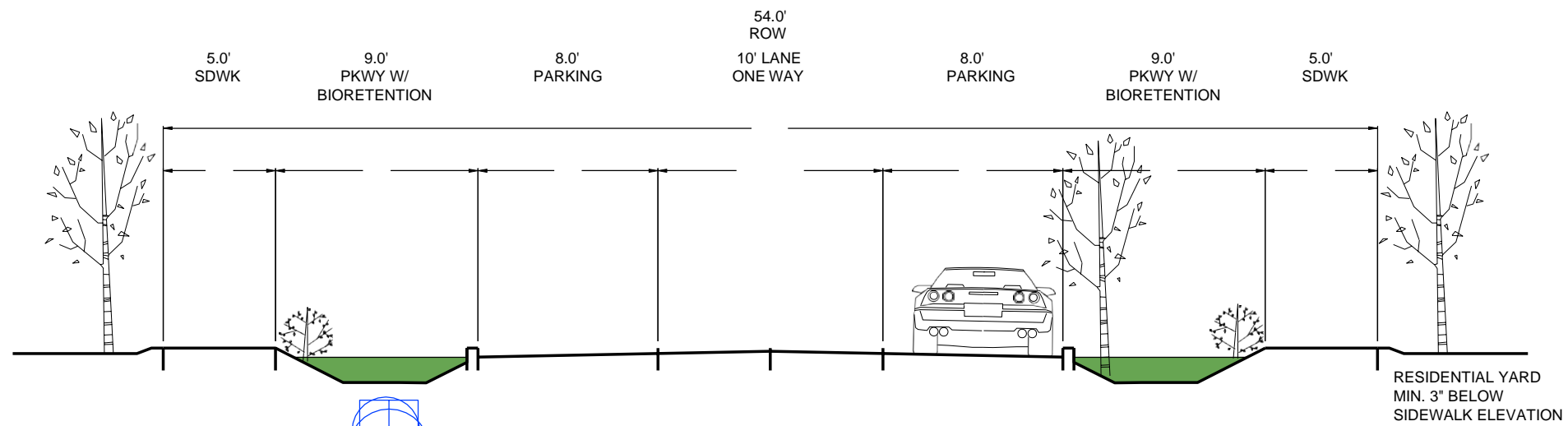
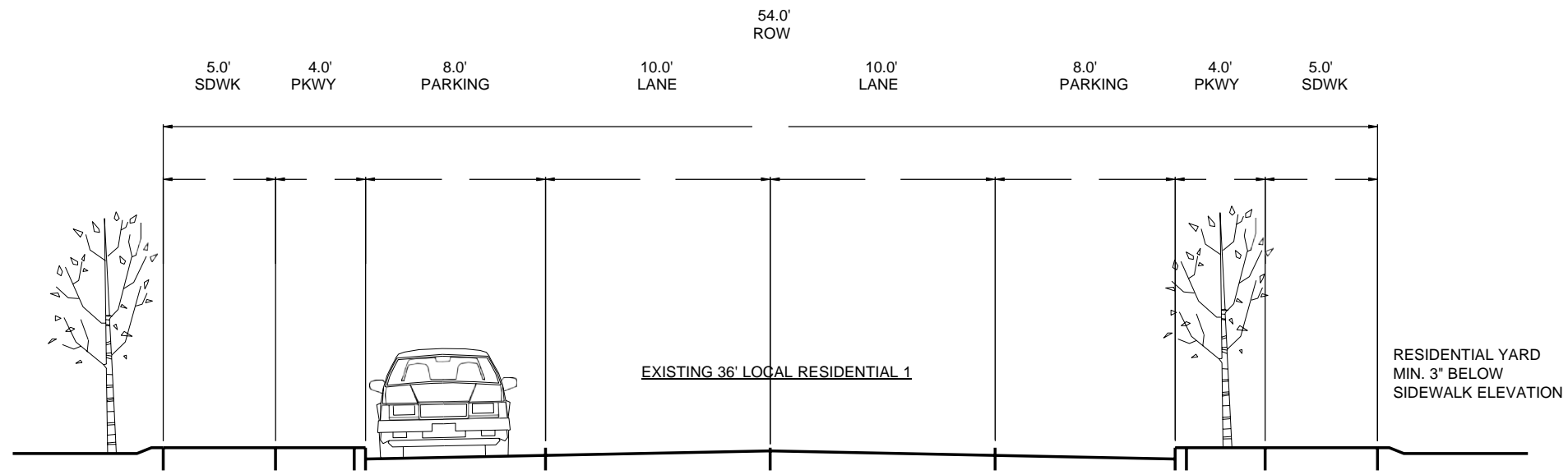

OPTIONAL: BELOW GRADE STORAGE CHAMBER. SHAPE AND VOLUME VARIES BY MANUFACTURER

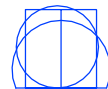

OPTION 1: ONE-WAY STREET WITHIN EXISTING R.O.W. W/ BIORETENTION BASINS

STORAGE OPTIONS WITHIN EXISTING RIGHT-OF-WAY LOCAL RESIDENTIAL STREETS  
CITY OF EL PASO  
STORMWATER DESIGN MANUAL

APPENDIX 3

FIGURE 3-1



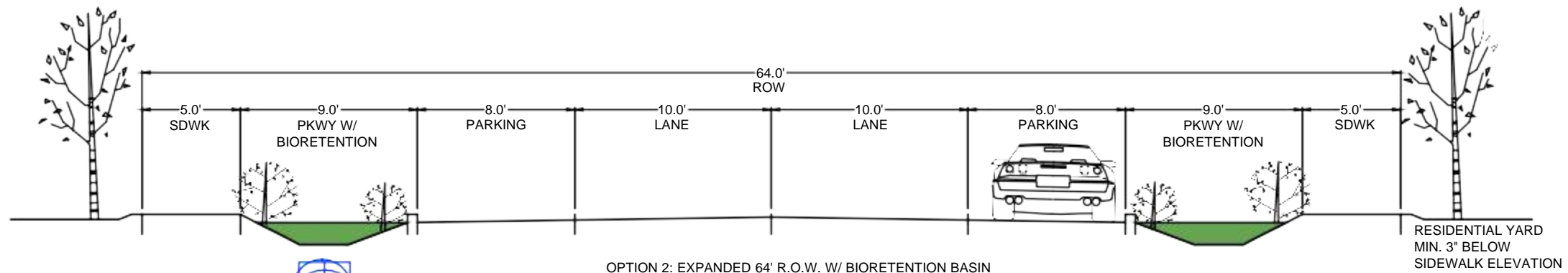

OPTION 2: EXPANDED 64' R.O.W. W/ BIORETENTION BASIN PLUS SUBSURFACE STORAGE



OPTIONAL: BELOW GRADE STORAGE CHAMBER. SHAPE AND VOLUME VARIES BY MANUFACTURER

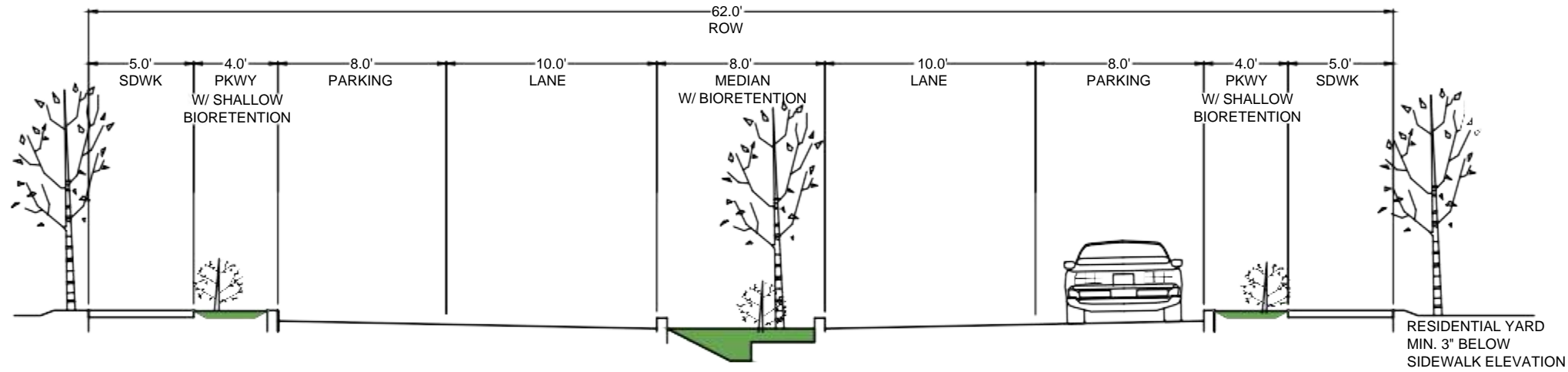

OPTION 3: EXPANDED 62' R.O.W. W/ BIORETENTION BASIN

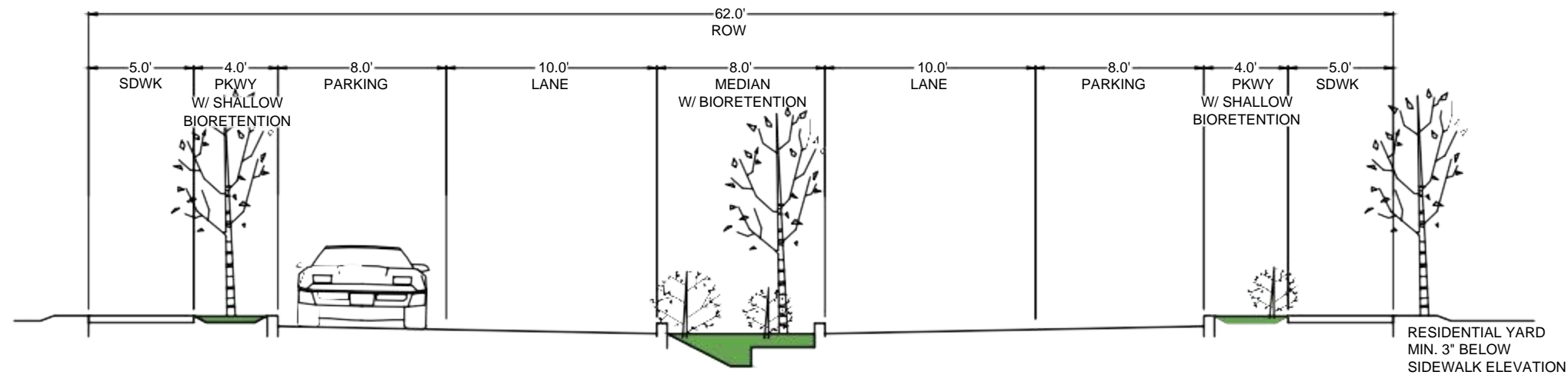

BELOW GRADE STORAGE CHAMBER. SHAPE AND VOLUME VARIES BY MANUFACTURER

OPTION 4: EXPANDED 62' R.O.W. W/ BIORETENTION BASINS. PLUS SUBSURFACE STORAGE

STORAGE OPTIONS WITHIN EXPANDED RIGHT-OF-WAY LOCAL RESIDENTIAL STREETS

CITY OF EL PASO  
STORMWATER DESIGN MANUAL

APPENDIX 3

FIGURE 3-2





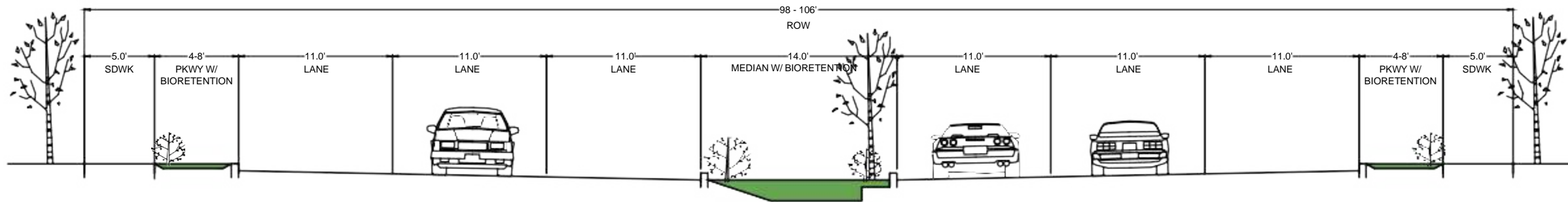

OPTION 5: MAJOR ARTERIAL W/ BIORETENTION BASINS

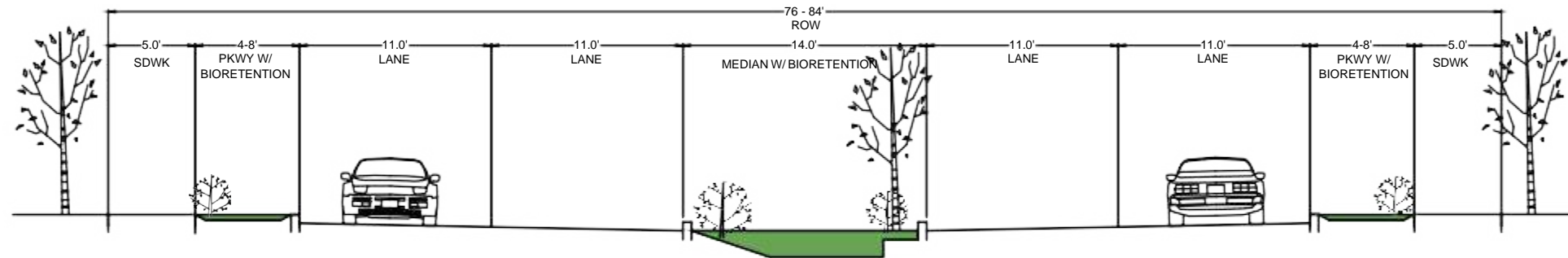

OPTION 6: MINOR ARTERIAL W/ BIORETENTION BASINS

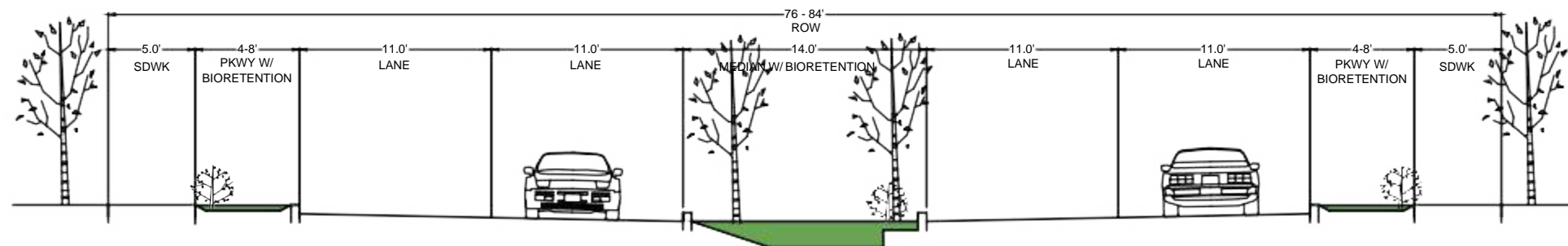

BELOW GRADE STORAGE CHAMBER. SHAPE AND VOLUME VARIES BY MANUFACTURER

OPTION 7: MINOR ARTERIAL W/ BIORETENTION BASINS PLUS SUBSURFACE STORAGE

STORAGE OPTIONS WITHIN  
RIGHT-OF-WAY OF  
MAJOR AND MINOR ARTERIAL  
STREETS  
CITY OF EL PASO  
STORMWATER DESIGN MANUAL

APPENDIX 3

FIGURE 3-3



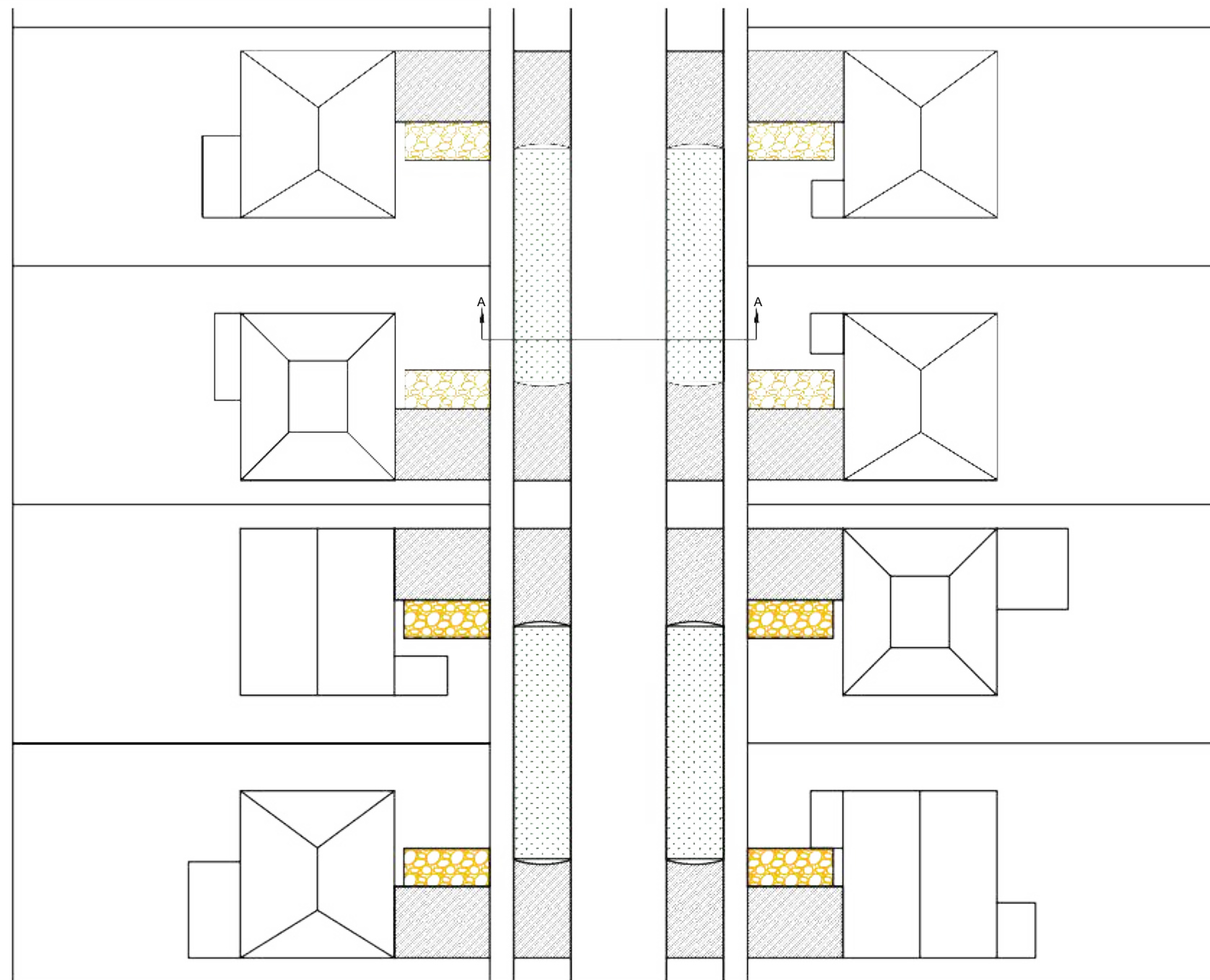

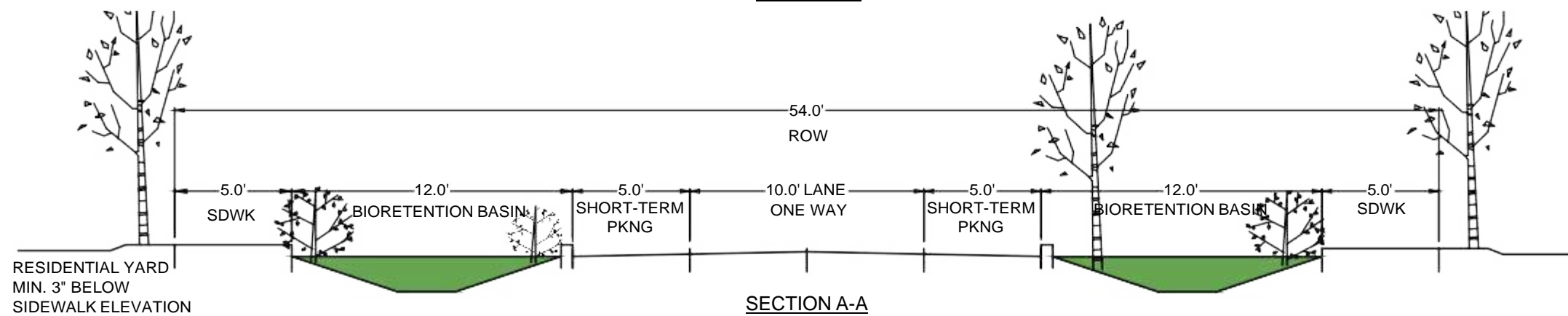

PLAN VIEW

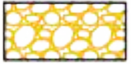

SECTION A-A

LEGEND

-  BIORETENTION BASIN
-  OFF-STREET PARKING SPACE, GRAVEL OR PERMEABLE
-  DRIVEWAY

NOTE:  
HOUSE/DRIVEWAY LAYOUT PATTERN  
DESIGNED TO MAXIMIZE AVAILABLE  
CONNECTED GREENSPACE FOR  
GREEN INFRASTRUCTURE FEATURES.

STREET EDGE ALTERNATIVE  
WITHIN EXISTING  
RIGHT-OF-WAY  
CITY OF EL PASO  
STORMWATER DESIGN MANUAL

APPENDIX 3

FIGURE 3-4



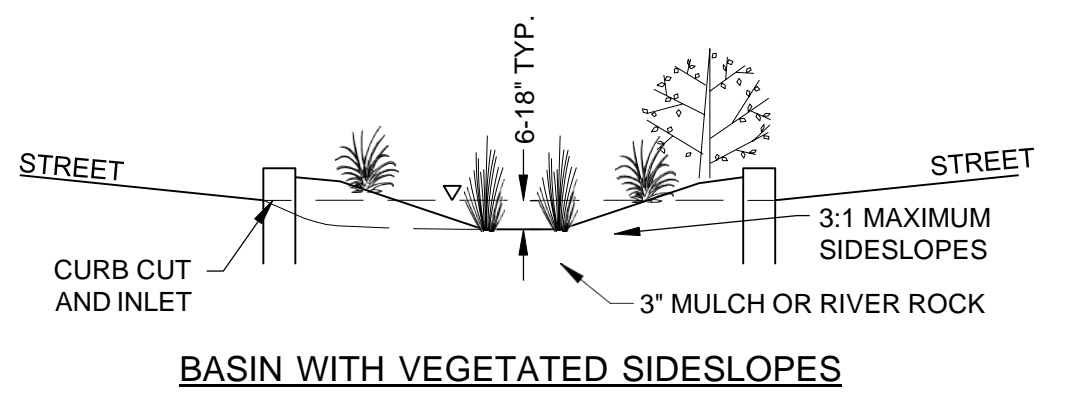
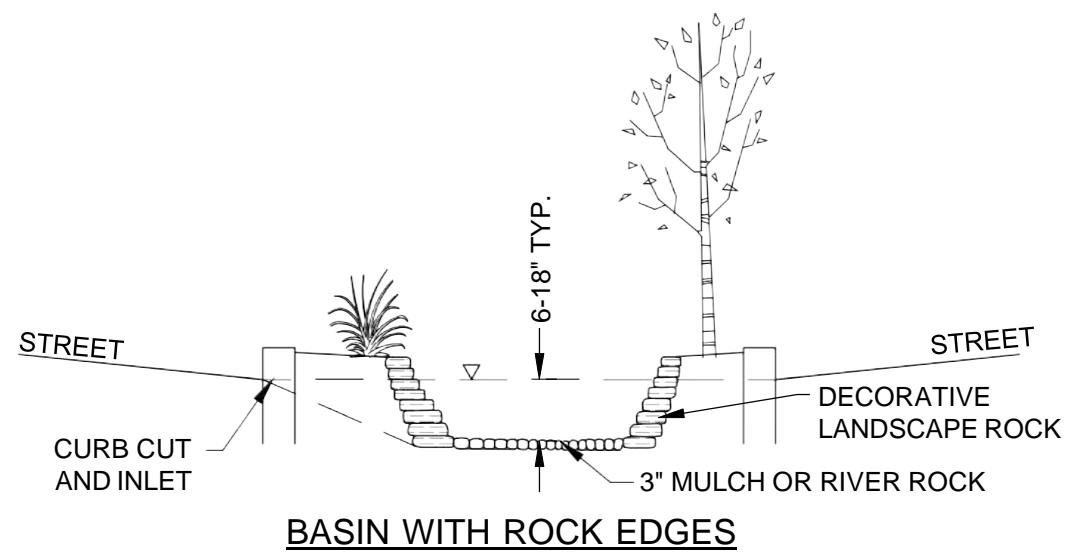
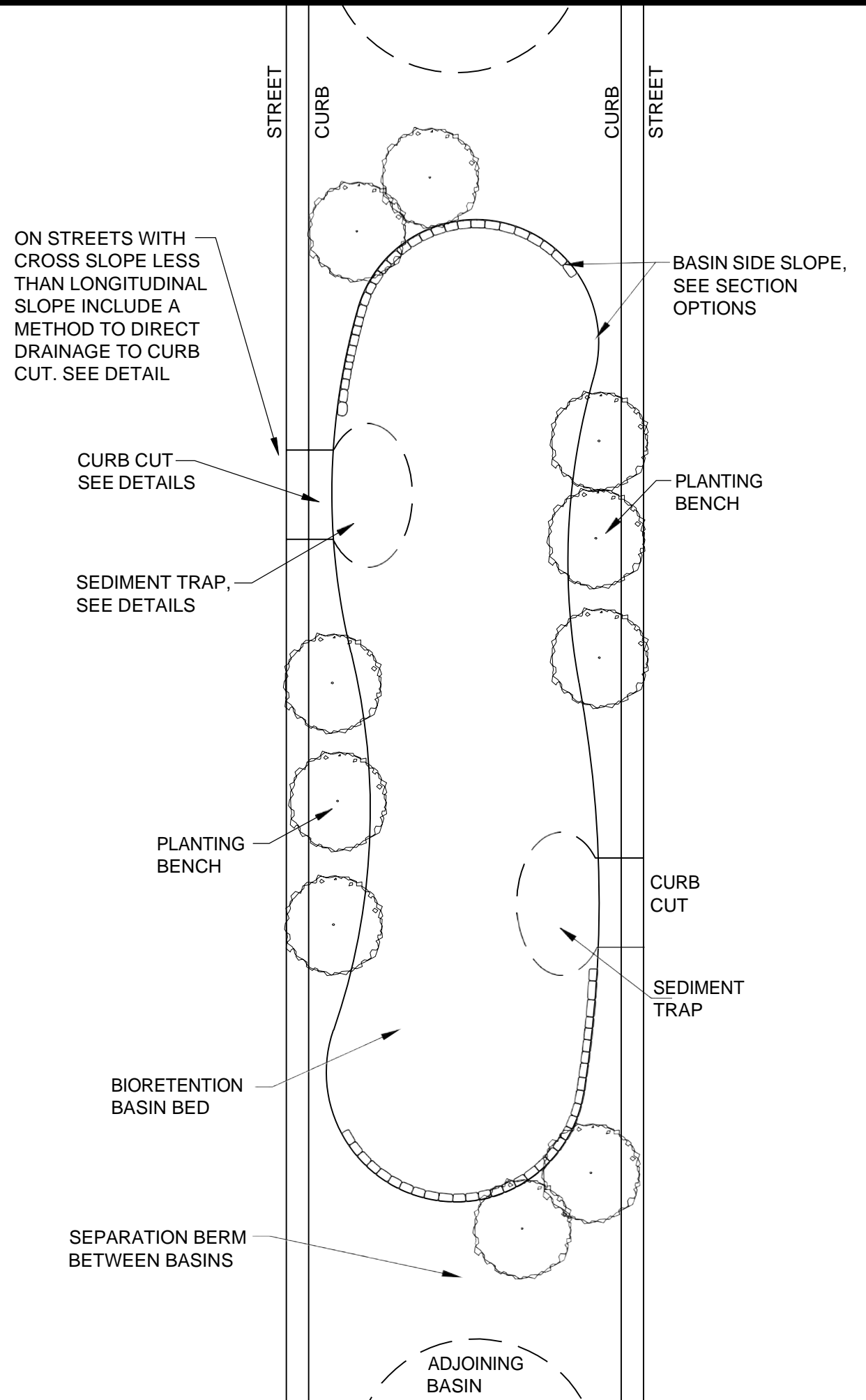

BIORETENTION BASIN IN STREET MEDIAN WITH CURB CUTS

CITY OF EL PASO  
STORMWATER DESIGN MANUAL

APPENDIX 3

FIGURE 3-5



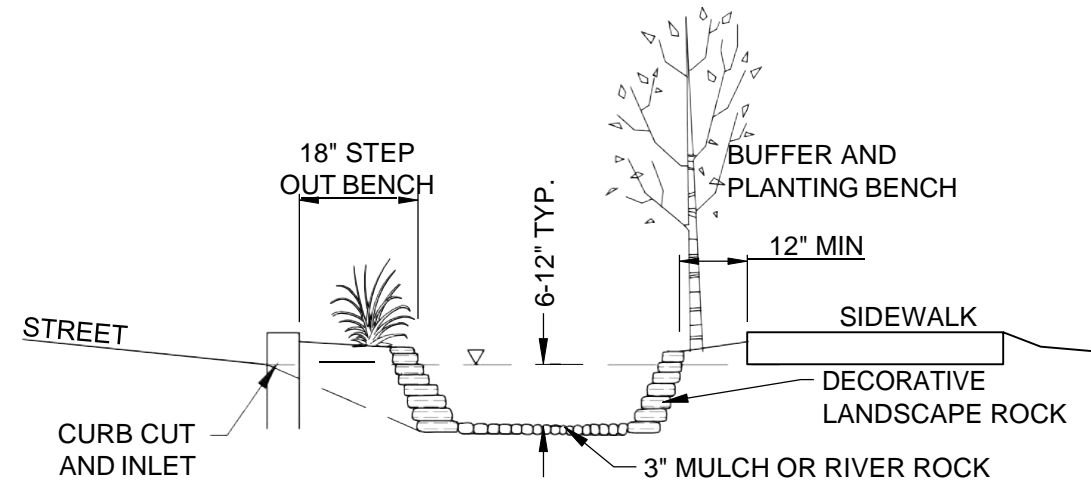
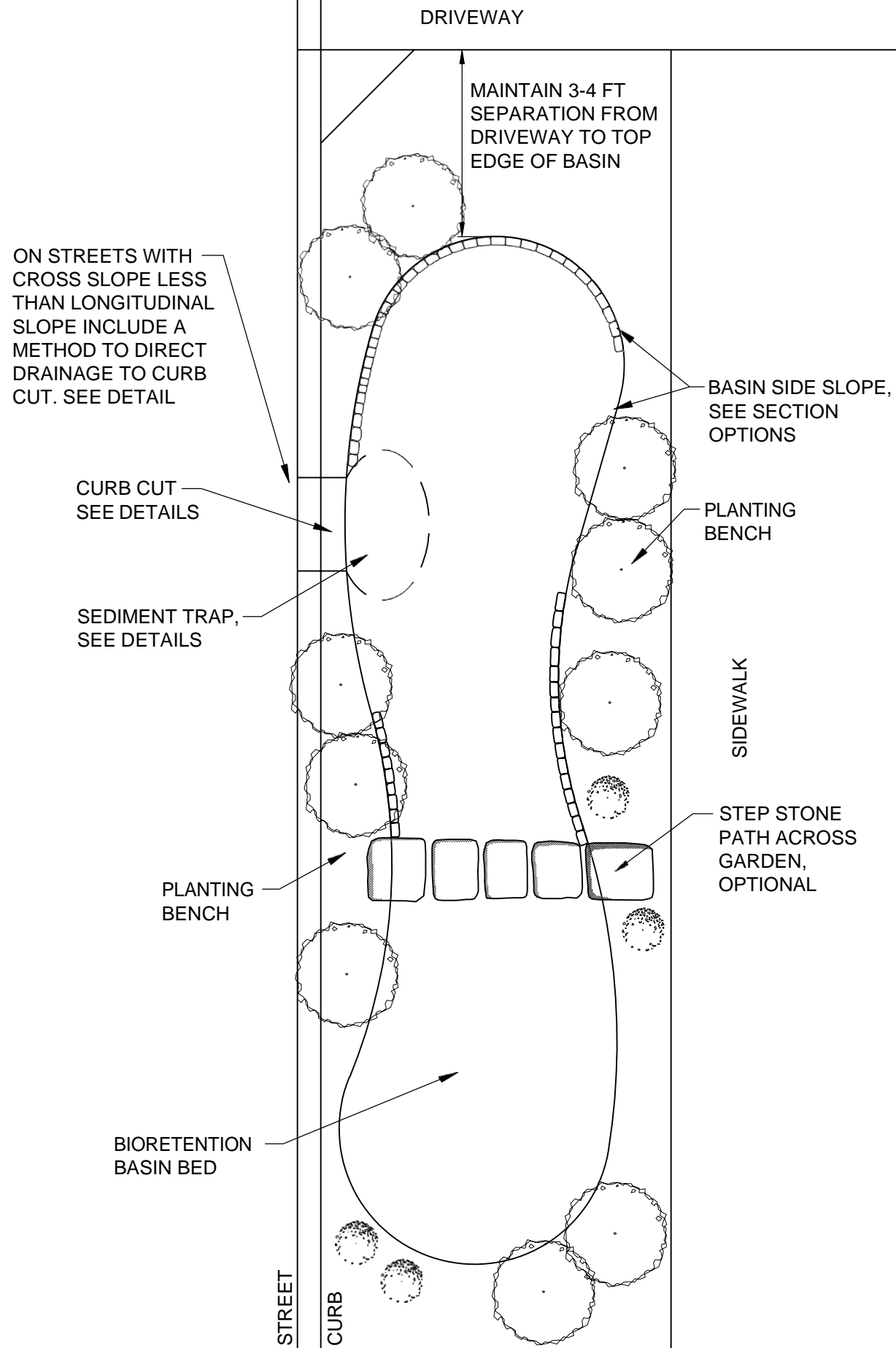

**BASIN WITH ROCK EDGES**

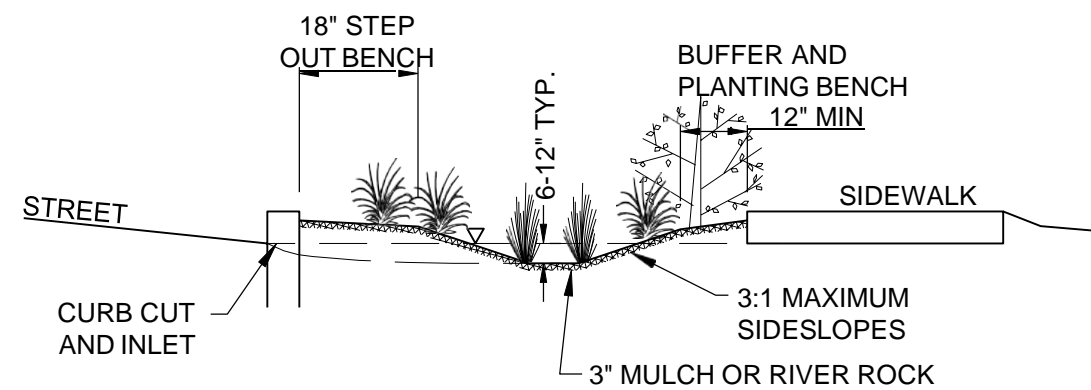

**BASIN WITH VEGETATED SIDESLOPES**

**BIORETENTION BASIN STREET EDGE WITH CURB CUT**

CITY OF EL PASO  
STORMWATER DESIGN MANUAL

APPENDIX 3

FIGURE 3-6



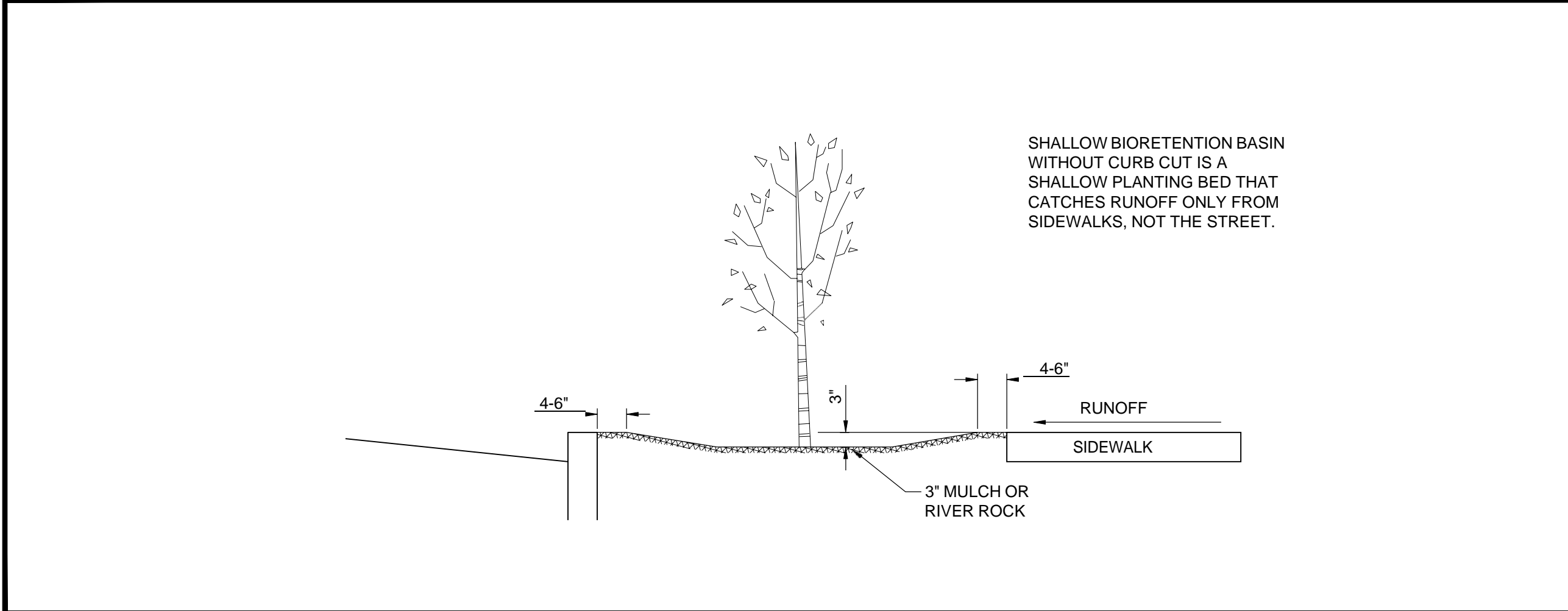
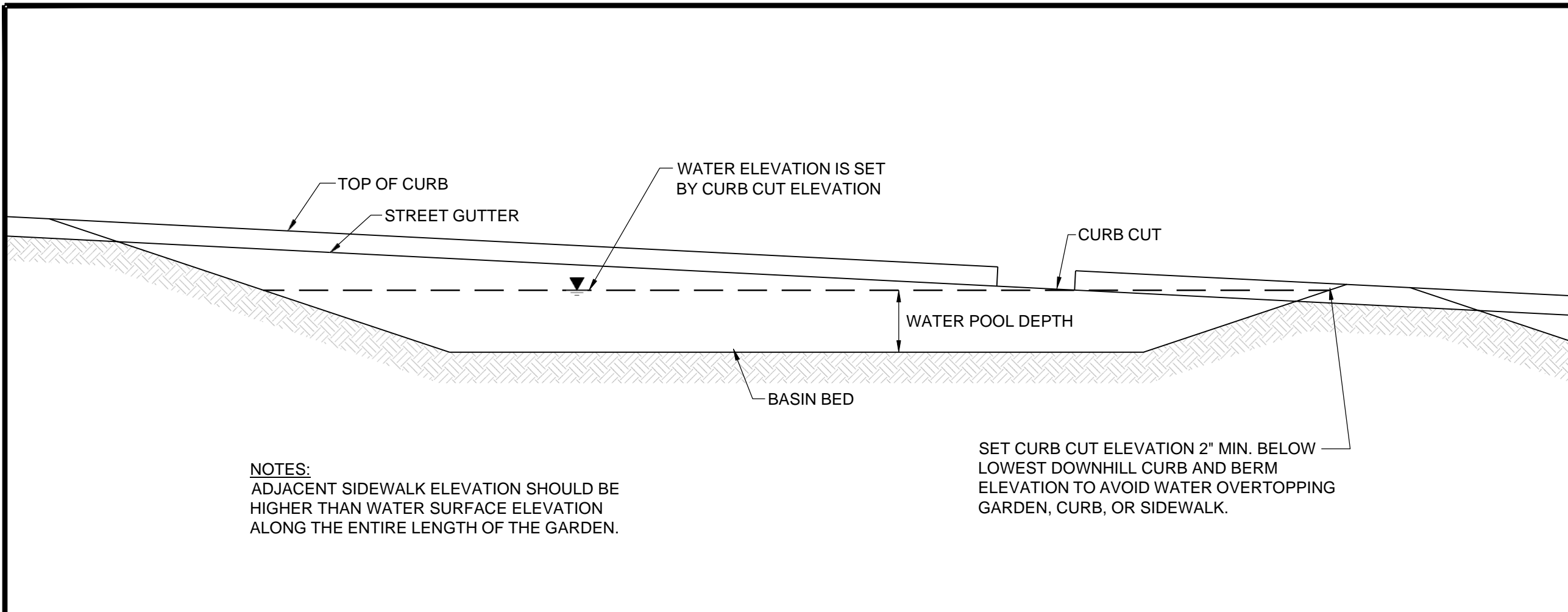

BIORETENTION BASIN PROFILE ON SLOPED STREETS AND SHALLOW BIORETENTION BASIN SECTION WITHOUT CURB CUT  
CITY OF EL PASO  
STORMWATER DESIGN MANUAL

APPENDIX 3

FIGURE 3-7



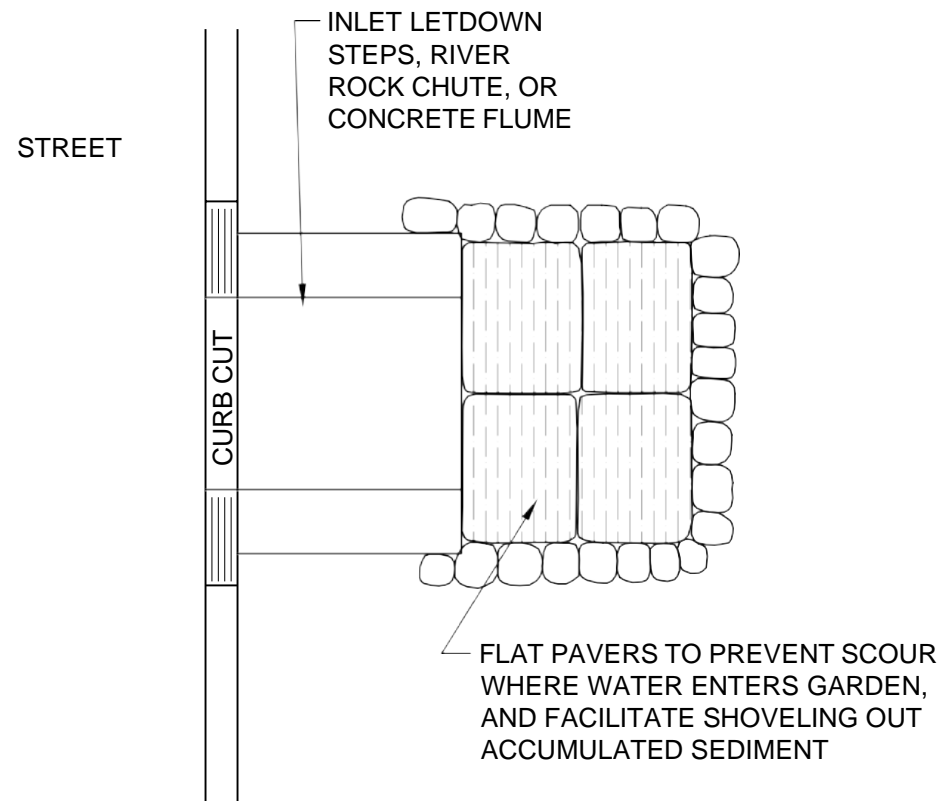
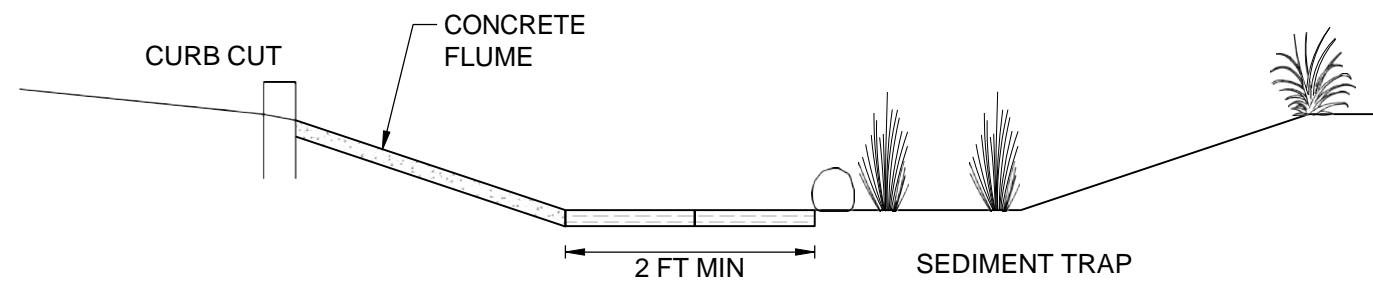
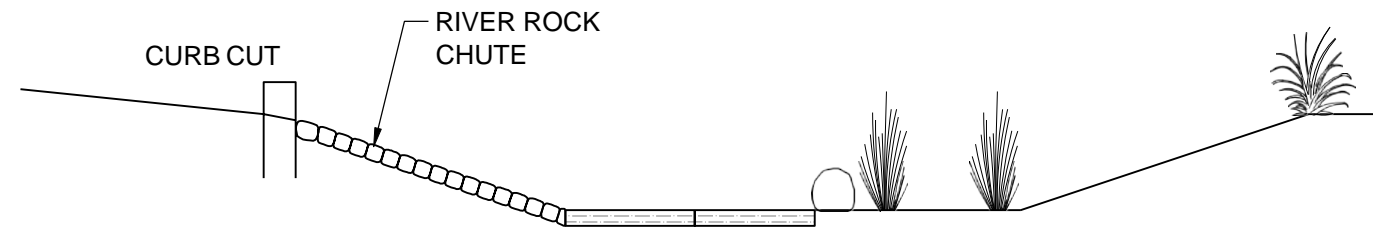
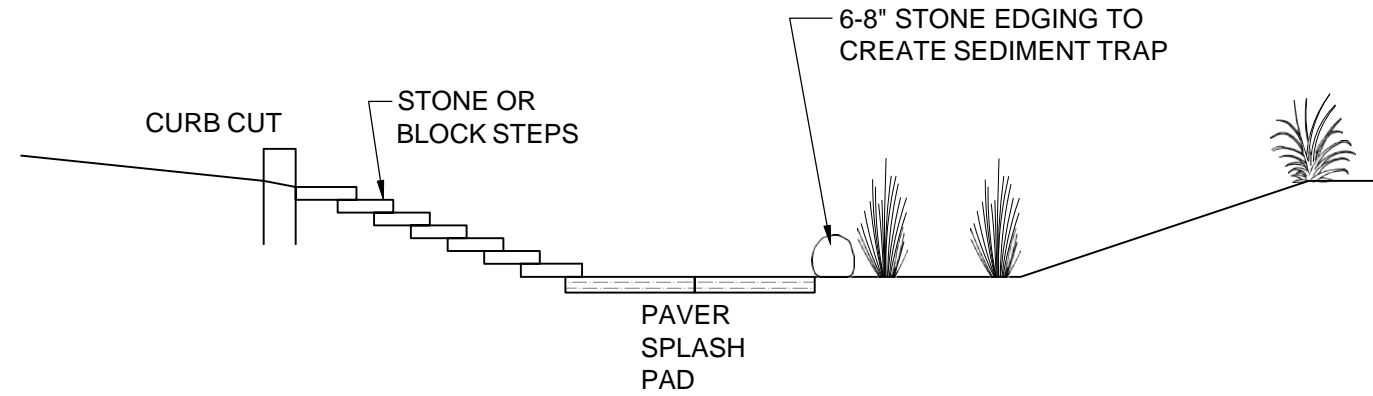
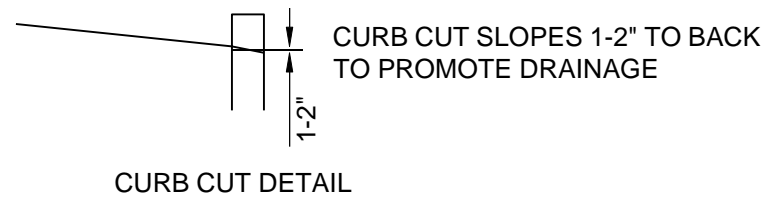
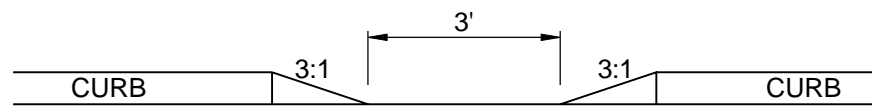

SEDIMENT TRAP DIMENSIONS VARY TO FIT SIZE OF BASIN - MIN. WIDTH TYP. 2 FT.

CURB CUT AND SEDIMENT TRAP OPTIONS

CITY OF EL PASO  
STORMWATER DESIGN MANUAL

APPENDIX 3

FIGURE 3-8



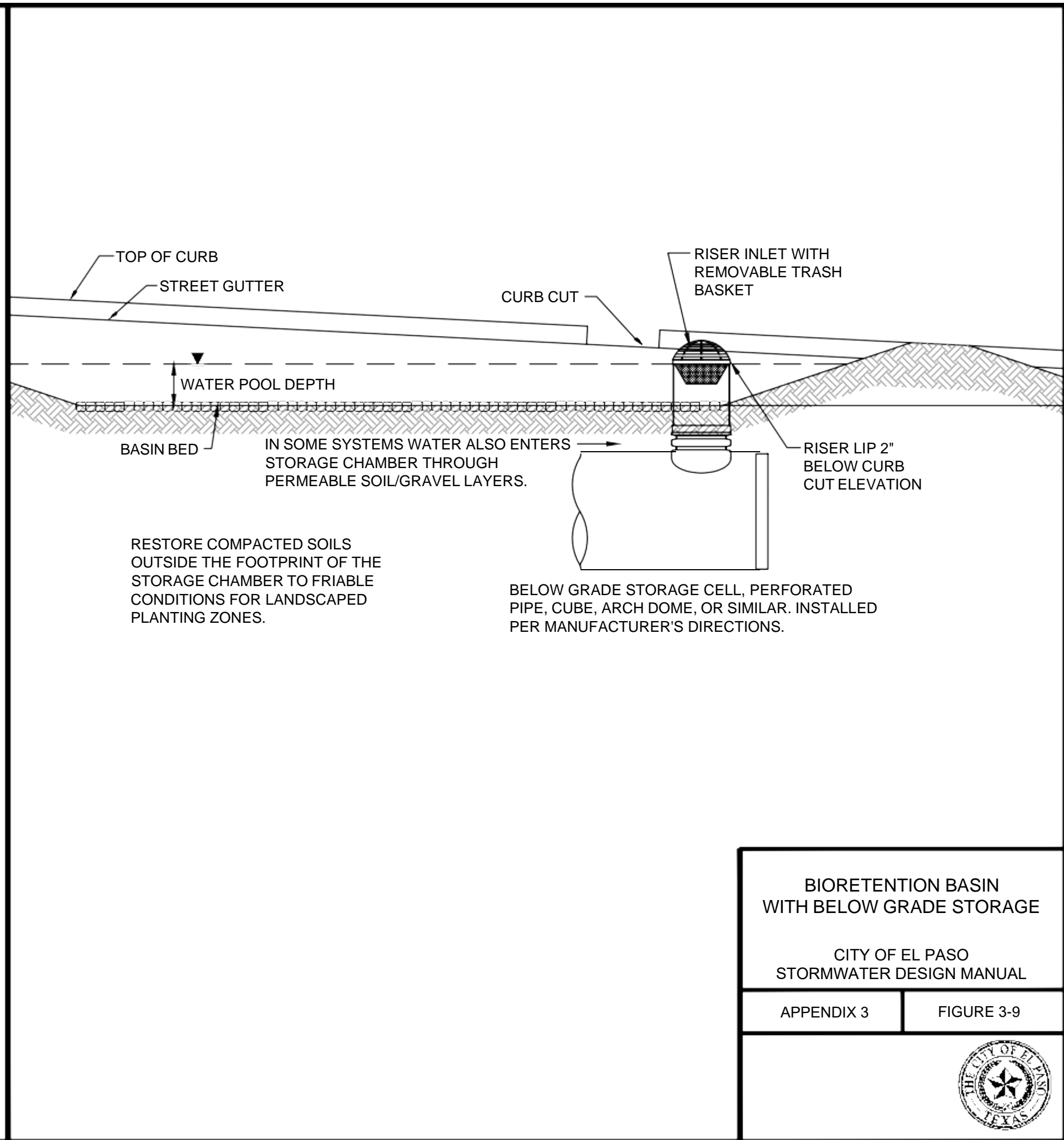
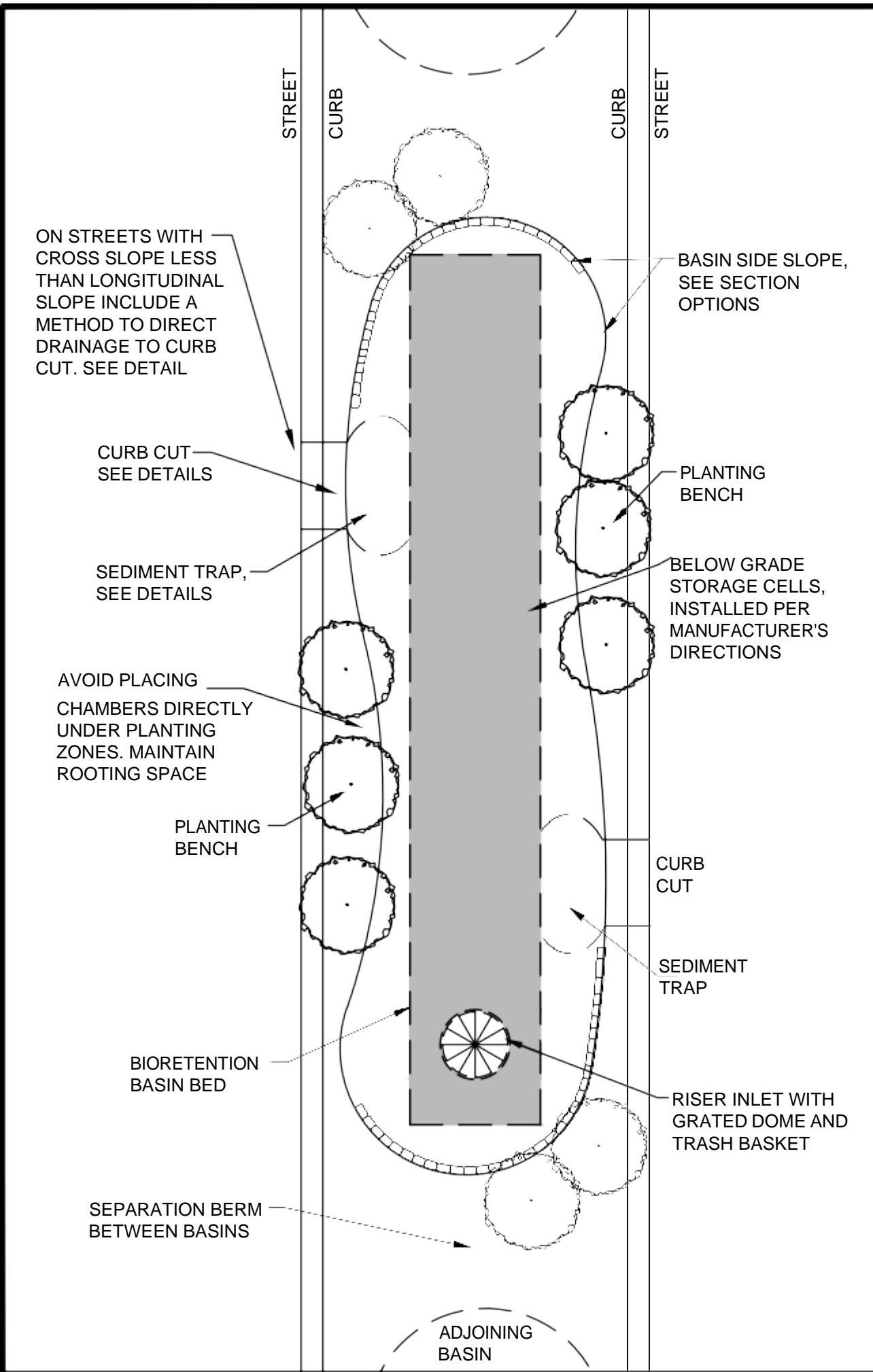

**BIORETENTION BASIN  
WITH BELOW GRADE STORAGE**

CITY OF EL PASO  
STORMWATER DESIGN MANUAL

APPENDIX 3	FIGURE 3-9
------------	------------



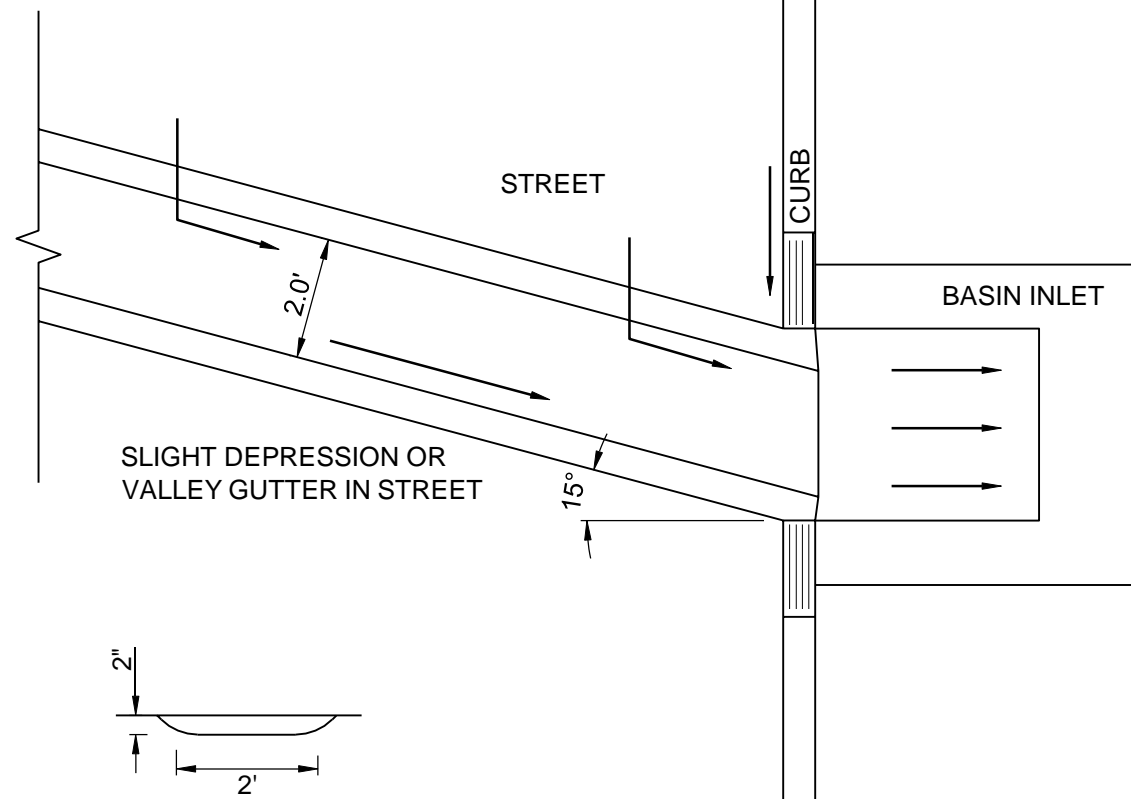
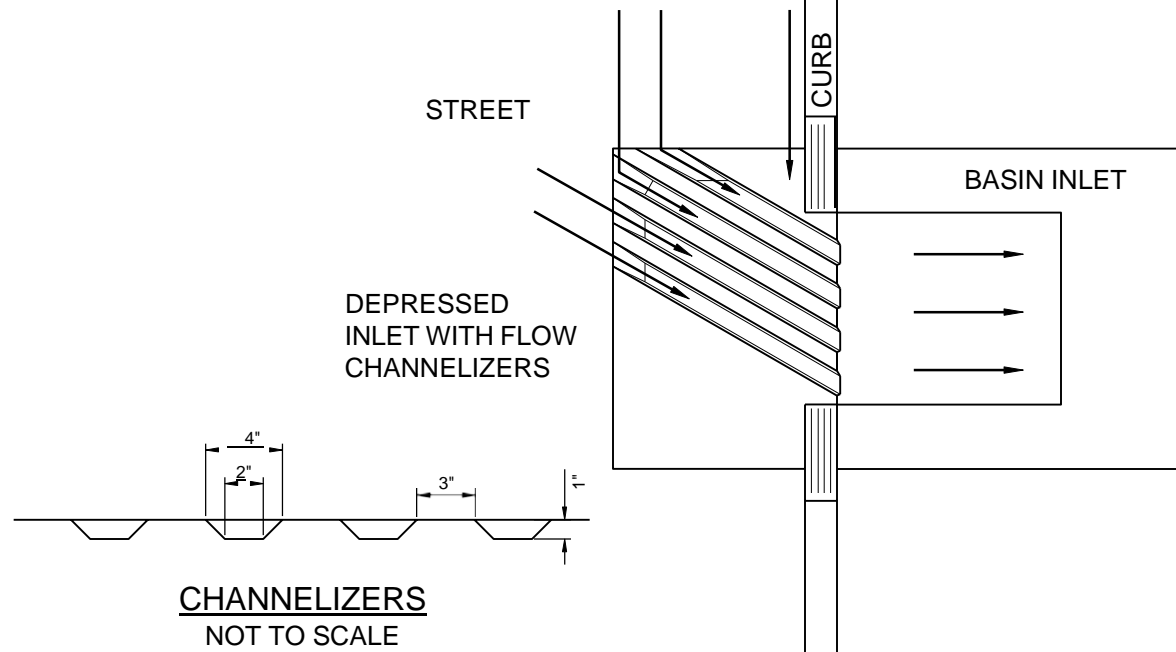

ON STREETS WITH CROSS SLOPE LESS THAN LONGITUDINAL SLOPE INCLUDE A METHOD TO DIRECT DRAINAGE TO CURB CUT.

→ STORMWATER FLOW

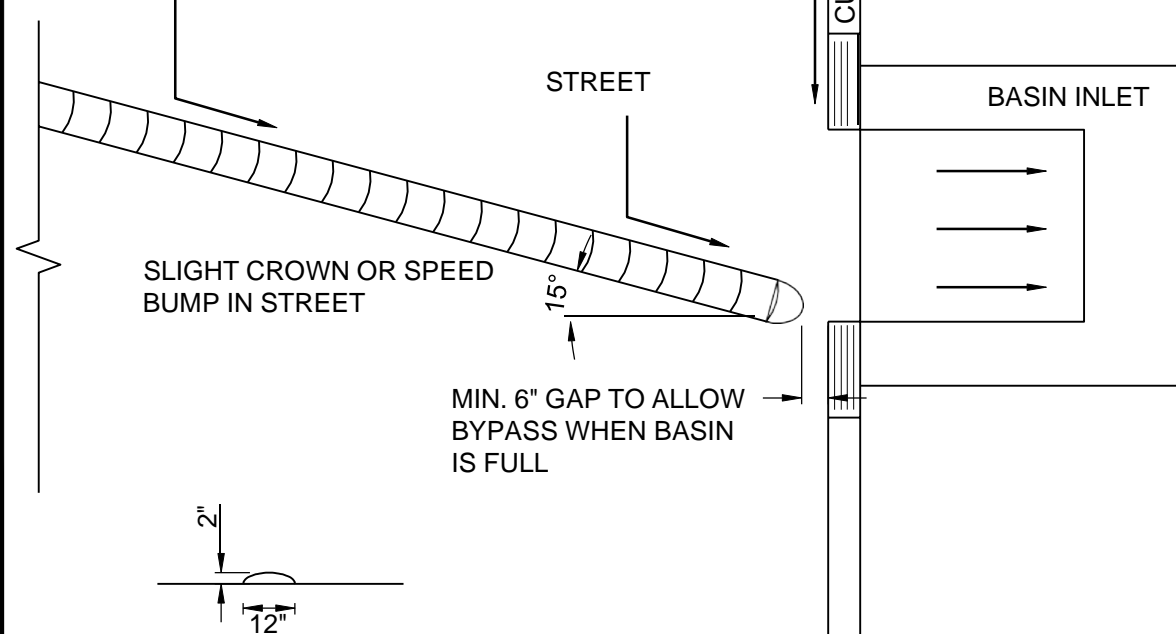
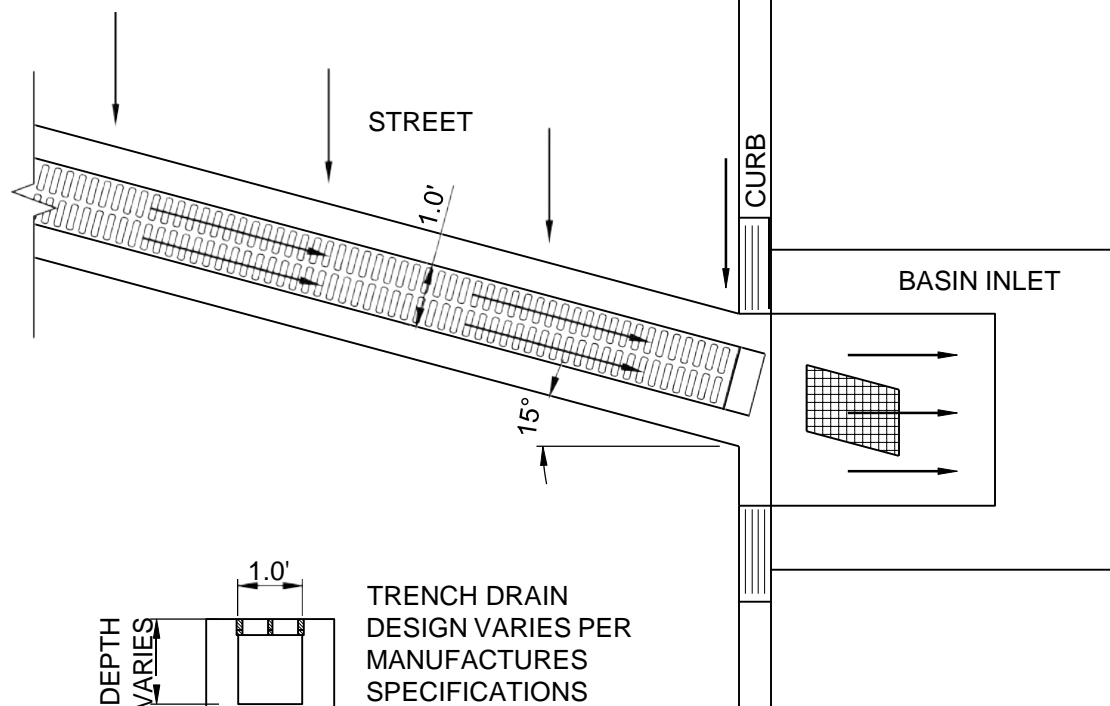

FLOW DIVERSION OPTIONS FOR STEEP STREETS

CITY OF EL PASO  
STORMWATER DESIGN MANUAL

APPENDIX 3

FIGURE 3-10





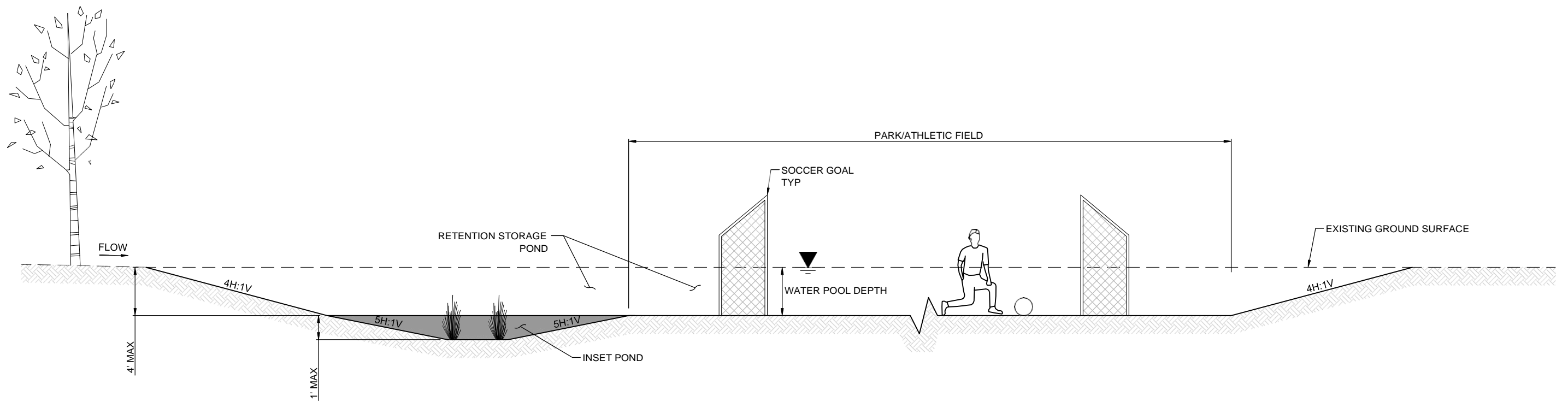

PARK POND ON FLAT EXISTING GROUND SURFACE  
N.T.S.

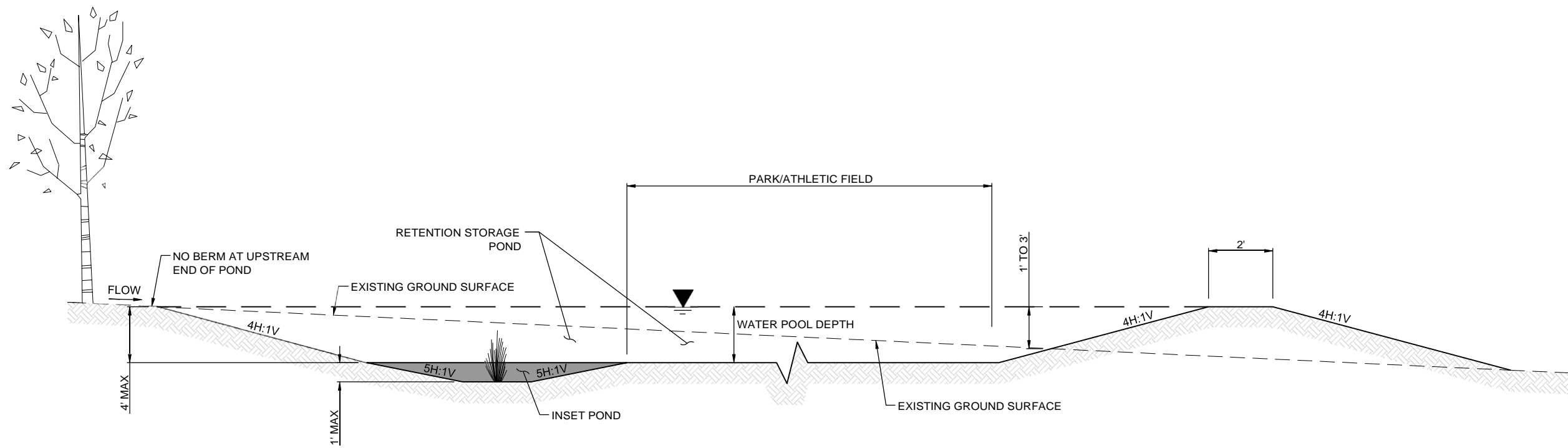

PARK POND ON INCLINED EXISTING GROUND SURFACE  
N.T.S.

CONCEPTUAL PARK POND  
CROSS-SECTION

CITY OF EL PASO  
STORMWATER DESIGN MANUAL

APPENDIX 3

FIGURE 3-11



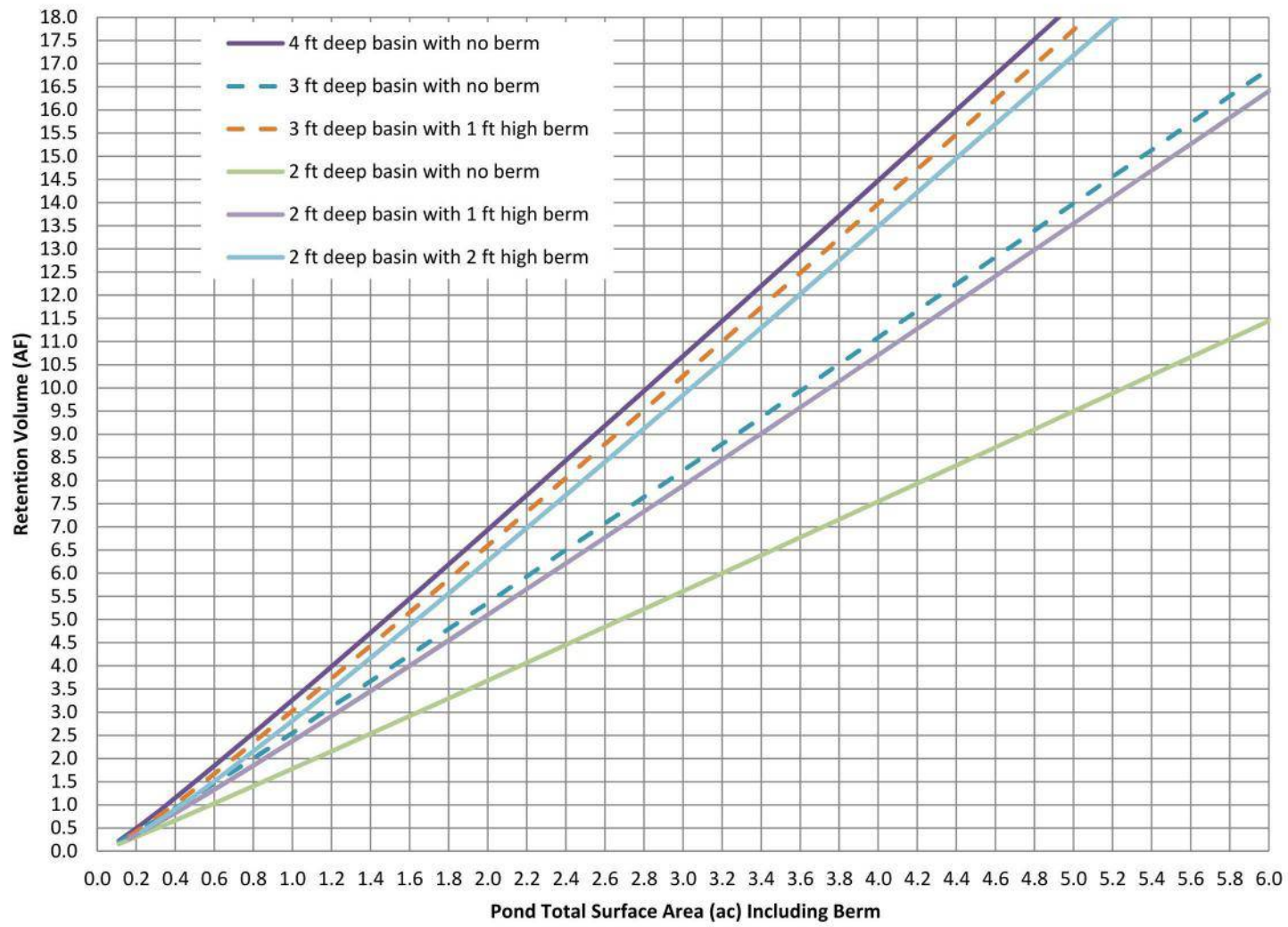

POND SITE AREA  
VERSUS RETENTION STORAGE

CITY OF EL PASO  
STORMWATER DESIGN MANUAL

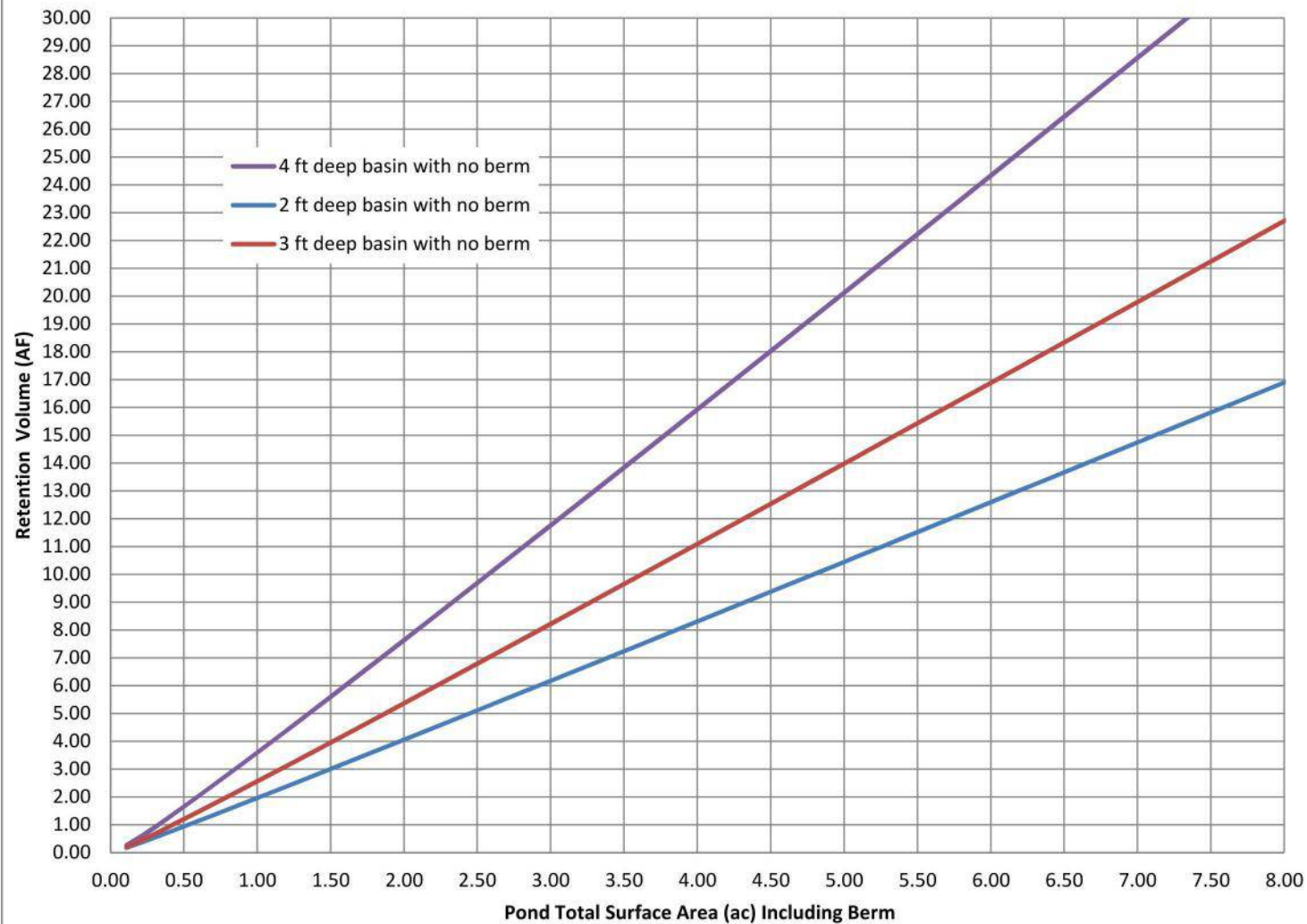

POND SITE AREA  
VERSUS RETENTION STORAGE  
EXPANDED

CITY OF EL PASO  
STORMWATER DESIGN MANUAL

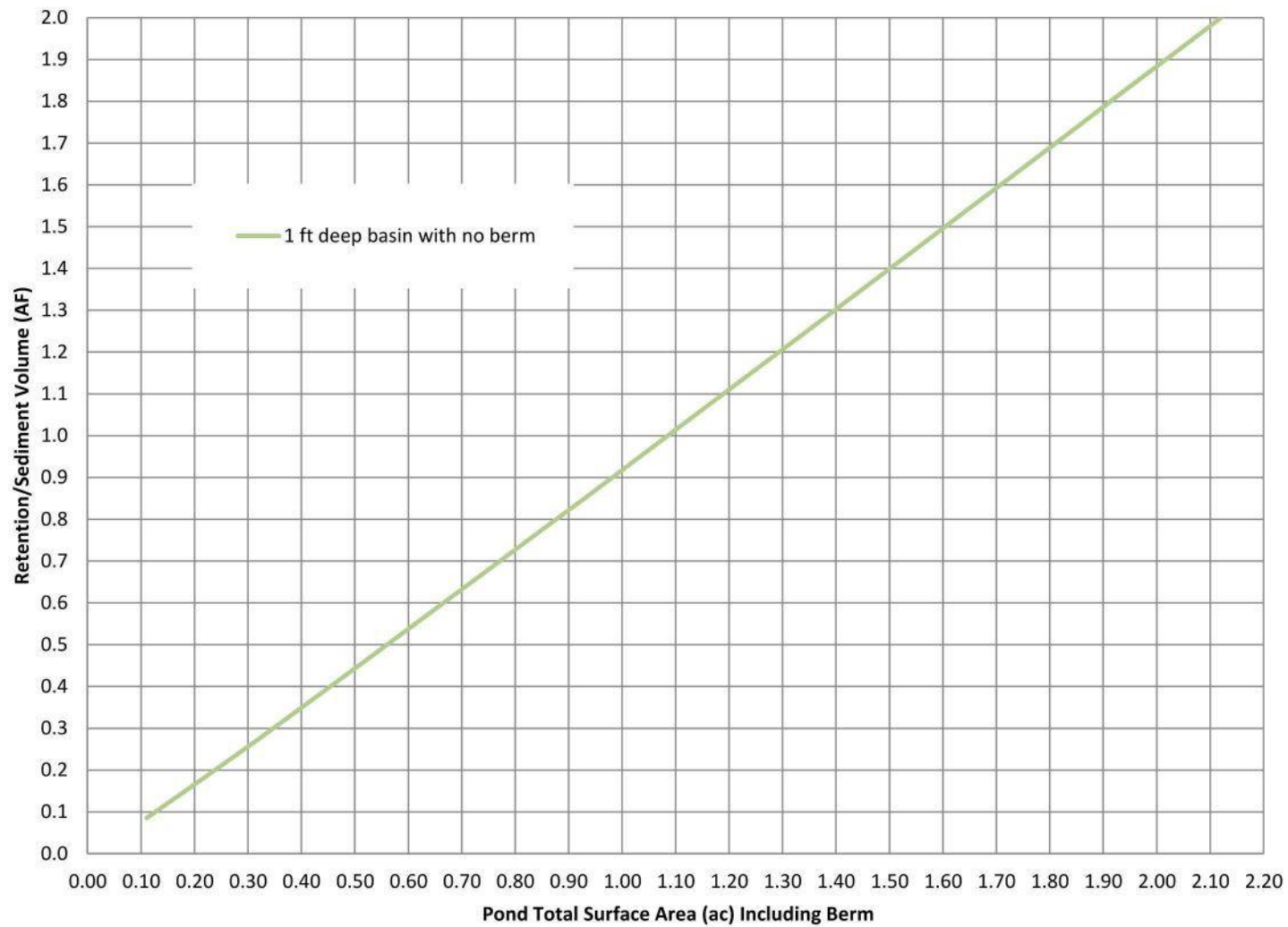

POND SITE AREA  
VERSUS RETENTION STORAGE  
INSET POND

CITY OF EL PASO  
STORMWATER DESIGN MANUAL



CITY OF EL PASO

APPENDIX 4

**DRAINAGE SUBMITTAL  
REQUIREMENTS AND CHECKLIST**

CONTENTS

---

APPENDIX 4. DRAINAGE SUBMITTAL REQUIREMENTS AND CHECKLIST BY PE,  
TEXAS ..... 1

    4.1 Deliverables ..... 1

    4.2 Drainage Report Checklist..... 1

    4.3 Calculations and Modeling Checklist ..... 2

    4.4 HEC-HMS Project Checklist..... 2

    4.5 Submittal Checklist ..... 4

## **APPENDIX 4. DRAINAGE SUBMITTAL REQUIREMENTS AND CHECKLIST BY PE, TEXAS**

### **4.1 DELIVERABLES**

- Drainage Report with Supporting Calculations
- Scour Analysis
- Grading and Drainage Plan

### **4.2 DRAINAGE REPORT CHECKLIST**

- General project location
- Development concept for the site
- Drainage concept for the site (include relevant #'s as appropriate)
- How off-site flows will be handled
- How on-site flows will be handled and discharged
- Downstream capacity and how it is determined
- Impacts on or requirements of other jurisdictions
- Identify all approvals being requested in conjunction with this submittal, such as:
  - Zone Change
  - Subdivision Plat
  - Site Plan for Subdivision
  - Site Development Plan for Building Permit
  - Building Permit
  - Grading Permit
  - Paving Permit
  - Design Variance
  - Conditional Letter of Map Revision (CLOMR), Letter of Map Revision (LOMR), or Letter of Map Amendment (LOMA)
  - 404 Permit
  - 408 Permit
- Previously approved drainage management plans, drainage reports, plans, or studies including watersheds, basins, drainageways, etc. as defined therein
- Legal description
- Identify proximity of site to a designated FEMA Flood Hazard Zone
- Include a copy of the relevant FEMA FIRM or Flood Boundary and Floodway Map with the site clearly identified along with all affected Flood Zones
- Identify portion of designated Flood Hazard Zone to be revised or amended when CLOMR, LOMR, or LOMA approval requested
- If vesting approved, standards in place when vesting occurred.

### 4.3 CALCULATIONS AND MODELING CHECKLIST

- Fully developed watershed, ability to accept and safely convey runoff generated from design storm
- Hydrologic Analysis
- Include rainfall from Tables 3-1 through 3-3 for the region used
- Watershed delineation, both existing and proposed basins and areas of each basin
- Point of discharges for each subbasin
- Any FEMA floodplains including both FIRM map and shapefiles
- Hydrologic soil groups and any calculations to go along with them
- Land cover assumptions (include areas of imperviousness, any supporting documentation, and calculations)
- Curve Numbers (include any supporting documentation and calculations)
- Mannings values and descriptions (include any supporting documentation and calculations)
- Time of Concentration (include any supporting documentation and calculations)
- Routing Reaches (include any supporting documentation and calculations)
- Sediment Bulking factors (include calculations)
- Peak Rate Factors (include any supporting documentation)
- Proposed stage storage discharge tables (include any supporting documents and calculations)
- Runoff coefficients development calculations or supporting information
- Shape files used for calculations (one combined geodatabase)
- Hydrologic Maps:
  - Overall drainage map to scale that includes contour data used to delineate basins for existing and proposed, areas of each basin, overall drainage area, and discharge locations
  - Subbasin map that includes time of concentration paths and lengths
  - Routing reaches (if applicable) and lengths
  - Hydrologic Soil Group Map

### 4.4 HEC-HMS PROJECT CHECKLIST

- Modeling input parameters
- Precipitation type and frequency
- Model run time
- Reservoir routing summary table which includes, peak inflow (cfs), peak discharge (cfs), inflow volume (acre-feet), discharge volume (acre-feet), time of peak inflow and time of peak discharge
- Summary table that includes hydrologic elements, drainage areas (mi<sup>2</sup> and acres), peak discharges (cfs), time of peak, and volume (acre-feet)
- Modeling package
- Any map layers associated with the model
- Hydraulic Capacity



- Street Capacity
  - Local street capacity calculations
- Collector calculations
  - Primary/Secondary Arterial calculations
  - $Q_{cap100}$  – 100-year Flow capacity (50-year, if vested)
  - $Q_{exp100}$  – 100-year Expected flow (50-year, if vested)
  - $V_{exp100}$  – 100-year Expected velocity (50-year, if vested)
- Dead end street draining to unpaved surface
  - Runoff Velocity less than six (6) feet per second
  - Ensure runoff will flow into drainage easement
- Storm Drain
  - 100-year Hydraulic Grade Line (50-year, if vested). Show on storm drain profiles and provide detailed calculations
  - Inlets designed for 25-year capacity
  - EGL: below top of curb and top of junction box
  - HGL: minimum at grate inlet elevation
  - Minimum easement: 15 feet minimum or 6 feet from pipe limits
  - Minimum pipe slope: 0.3%
  - Minimum cleaning velocity three (3) feet per second
  - Maximum permissible velocity: for trunk lines fifteen (15) feet per second and for laterals there is no limit
  - Reinforced concrete pipes under public streets
  - Pipe Diameter: trunk lines minimum of 24"
- Channels
  - Crossing structures
  - Storm inlet and/or entrance conditions
  - Contain water surface for  $Q_{100}$  plus freeboard
  - Channel bend freeboard calculations
  - Verify the channel has adequate drainage easement
  - Include a channel maintenance schedule for new channels
    - Mannings roughness coefficients (any calculations and supporting documentation)
    - Earthen Channel calculations
    - Concrete channel calculations
    - Side-lot Flumes: Public easements verify 10 feet access on one side and 2 on the other, Private easements verify 2 feet on either side, slope and velocity are same for concrete channels
    - Turf reinforcing matting: velocity minimum of six (6) feet per second and maximum of twelve (12) feet per second, include all supporting documentation
    - Interceptor Channel calculations

- Handrails or fencing required on vertical headwalls greater than 2 feet in height and wing walls with slopes steeper than 2:1
- Outfalls/Outlets/Transitions
  - Velocity control erosion protection measures
  - Outfall velocity
  - Outfall energy dissipator and any calculations
  - Hydrograph timing and analysis of backwater
- Pond Data
  - Detention pond/reservoir
  - Retention pond
  - Flood zone impacts of changes
  - Stability
  - Channel/Arroyo
  - Natural slope
  - Cut/Fill slope
  - Sediment bulking
  - Outfall pipe calculations (e.g. Orifice, culvert, weir, combination, ect.)
  - Outfall discharges and include any control measures (if applicable)
  - Tailwater elevations used in hydraulic calculations
  - Offsite sheet flow analysis (if applicable)
  - Open channel hydraulic calculations (if applicable)
  - Inlet designs
  - Provide detail on low water crossings

#### **4.5 SUBMITTAL CHECKLIST**

- Professional Engineer's stamp with signature and date
- North Arrow
- Scales
- Legend
- Plan drawings size: 24" x 36" or 11"x17"
- Notes defining property line, asphalt paving, sidewalks, planting areas, ponding areas, project limits, exist. or proposed ROW, Easements, Streets, Utilities, significant structures and all other areas whose definition would increase clarity
- Final elevations

- Proposed and existing contours, drainage flow patterns
- Grade change and grade break locations
- Slope arrow and slope percentage
- Vicinity Map
- Benchmark - location, description, and elevation in State Plane
- Coordinates Permanently marked temporary benchmark located on or very near site
- Flood Hazard Boundary Map (FHBM) or effective FIRM
- Legal description
- Off-Site Drainage



CITY OF EL PASO

APPENDIX 5

**HEC- HMS TUTORIAL**

## CONTENTS

---

APPENDIX 5. HEC-HMS PROJECT TUTORIAL.....	1
5.1 Introduction to HEC-HMS .....	1
5.2 Process of Creating an HEC-HMS Project.....	2
5.2.1 Creating a New Project.....	2
5.2.2 Creation of Components.....	3
5.3 Input Data .....	5
5.3.1 Basin Model .....	6
5.3.2 Meteorologic Model .....	11
5.3.3 Control Specification.....	13
5.4 Create Computation Run .....	19
5.5 Results .....	24

## LIST OF FIGURES

---

Figure 5- 1: HEC-HMS Interface .....	1
Figure 5- 2: Create a New Project.....	2
Figure 5- 3: Project Details.....	3
Figure 5- 4: Creating Components.....	3
Figure 5- 5: Creating a New Watershed Basin .....	4
Figure 5- 6: Creating a New Meteorological Model.....	4
Figure 5- 7: Creating a New Control Specification .....	4
Figure 5- 8: Watershed Explorer Example.....	5
Figure 5- 9: Hydrologic Elements in HEC-HMS Toolbar .....	5
Figure 5- 10: Creating a New Subbasin .....	6
Figure 5- 11: Subbasin Input Parameters .....	6
Figure 5- 12: Subbasin Loss Input Parameters .....	7
Figure 5- 13: Subbasin Transform Input Parameters .....	8
Figure 5- 14: Turning on Sediment Bulking Factors .....	9
Figure 5- 15: Subbasin Options Input Parameters .....	9
Figure 5- 16: Creating a Routing Reach.....	9
Figure 5- 17: Routing Reach Desktop Image .....	10
Figure 5- 18: Routing Reach Input Parameters .....	10
Figure 5- 19: Routing Reach Input Parameters .....	11

Figure 5- 20: Meteorological Model Input Parameters.....	12
Figure 5- 21: Meteorological Modeling Basins.....	12
Figure 5- 22: Frequency Storm Input Parameters.....	13
Figure 5- 23: Example Control Specifications .....	14
Figure 5- 24: Adding Storage Discharge Functions .....	15
Figure 5- 25: Adding Elevation Storage Function.....	15
Figure 5- 26: Adding Elevation Discharge Function.....	15
Figure 5- 27: Paired Data Functions .....	15
Figure 5- 28: Paired Data Input Parameters .....	16
Figure 5- 29: Paired Data Table Input Parameter .....	16
Figure 5- 30: Paired Data Graph.....	17
Figure 5- 31: Creating a New Reservoir .....	17
Figure 5- 32: Reservoir Input Parameters .....	18
Figure 5- 33: Reservoir Options Input Parameters .....	18
Figure 5- 34: Example of Complete Watershed Explorer.....	19
Figure 5- 35: Example of Desktop Window.....	19
Figure 5- 36: Creation of New Simulation Run.....	20
Figure 5- 37: Step One of Simulation Run.....	20
Figure 5- 38: Step Two of Simulation Run .....	21
Figure 5- 39: Step Three of Simulation Run .....	21
Figure 5- 40: Step Four of Simulation Run.....	22
Figure 5- 41: Example of Simulation Run .....	22
Figure 5- 42: Compute Icon in Toolbar .....	23
Figure 5- 43: Another Option to Run Model.....	23
Figure 5- 44: Progress Bar.....	23
Figure 5- 45: Creation from Results .....	24
Figure 5- 46: Global Results Table.....	25
Figure 5- 47: Detailed Lists for Each Hydrologic Element.....	25

## APPENDIX 5. HEC-HMS PROJECT TUTORIAL

---

### 5.1 INTRODUCTION TO HEC-HMS

According to US Army Corps of Engineers, Hydrologic Engineering Center's Hydrologic Modeling System (HEC-HMS) is designed to simulate the complete hydrologic process of dendritic watersheds systems. HEC-HMS is designed to be applicable in a wide range of geographic areas for solving a broad range of problems. This includes large river basin water supply and flood hydrology to small urban or natural watershed runoff. Hydrographs produced by the program can be used directly or in conjunction with other software for studies of water availability, urban drainage, flow forecasting, future urbanization impact, reservoir spillway design, flood damage reduction, floodplain regulation and systems operations. HEC-HMS also includes procedures necessary for continuous simulation including evapotranspiration, snowmelt, and soil moisture accounting. Supplemental analysis tools are provided for model optimization, forecasting streamflow, depth-area reduction, assessing model uncertainty, erosion and sediment transport, and water. This section was developed using HEC-HMS latest version interface.

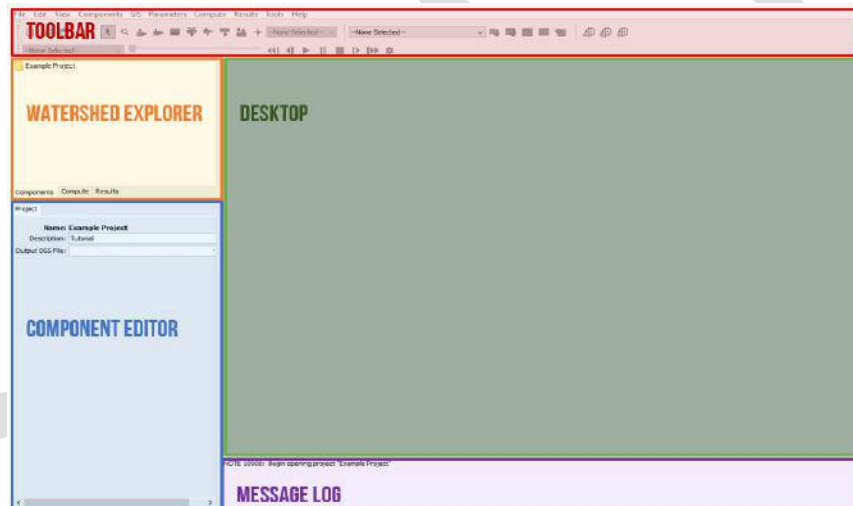

**Figure 5- 1: HEC-HMS Interface**

- Tool Bar: Location of information needed to create new components for a watershed.
- Watershed Explorer: Provides quick access to the three parts contained in an HEC-HMS Project: components, compute, and results. Components show the hierarchical structure of model components. Compute shows all the project simulation runs, optimization trials and analyses. The results tab shows the modeling results.
- Component Editor: Area to enter all data for the model.
- Desktop: Hold a variety of windows including summary tables, time series tables, graphs, global editors, and the basin model map.
- Message Log: This is where any notes, warnings, and errors are shown.

## 5.2 PROCESS OF CREATING AN HEC-HMS PROJECT

The following sections will provide a step-by-step guide on how to build an HEC-HMS project utilizing the guidelines provided on the selection of Hydrologic Parameters.

If more information on a certain category is required, it is suggested to refer to the HEC-HMS user manuals and guides (for the version that is being used) provided on the US Army Corps of Engineers website. The HEC-HMS model should be simple enough to be used by reviewers, including descriptions on subbasins and choosing a naming convention that makes sense. Bold text contained in the following sections is to show the user what will be common input parameters among all models.

### 5.2.1 Creating a New Project

Set up a project in HEC-HMS.

#### Input Parameters for HEC-HMS

1. **File > New**
2. **Name Project**
3. **Provide an optional description of the project**
4. **Select a location where the project files will be stored. A new folder in this selected location will be created automatically.**
5. **Choose the units for the project, the default option is U.S Customary.**

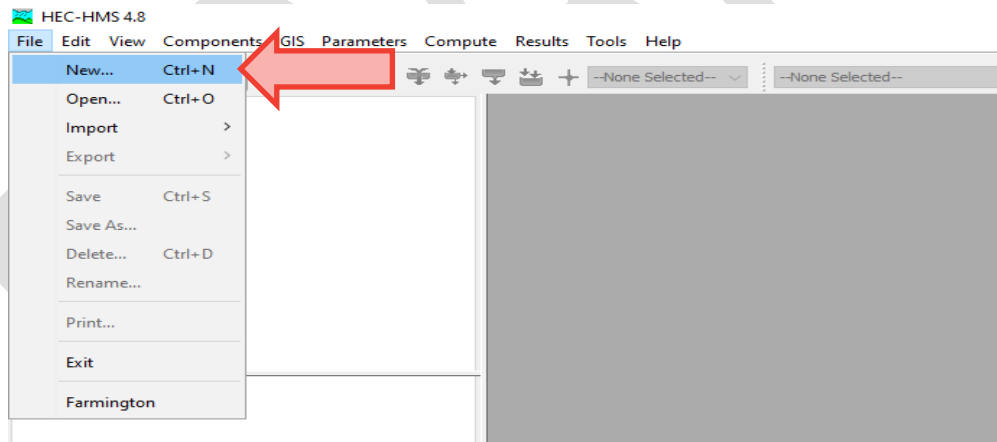

*Figure 5- 2: Create a New Project*



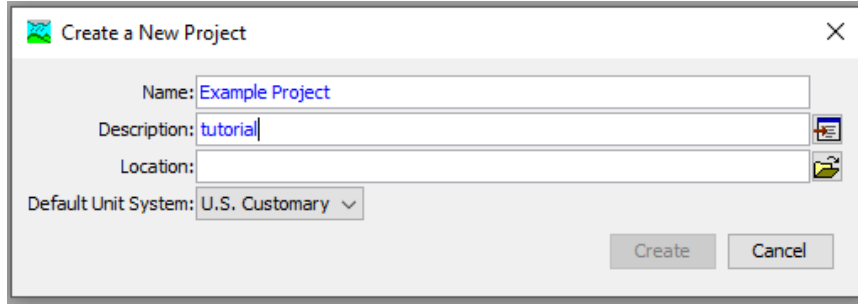

Figure 5- 3: Project Details

### 5.2.2 Creation of Components

Next step requires setting up the components for the Input Data into the model. The first three options in Figure 5- 4, (Basin Model, Meteorological Model and Control Specifications) are required for the model to run. The last four options (Time-Series Data, Paired Data, Grid Data and Terrain Data) are optional depending on the situation for which the model is being created. All of these options will have separate folders that are created within the Watershed Explorer.

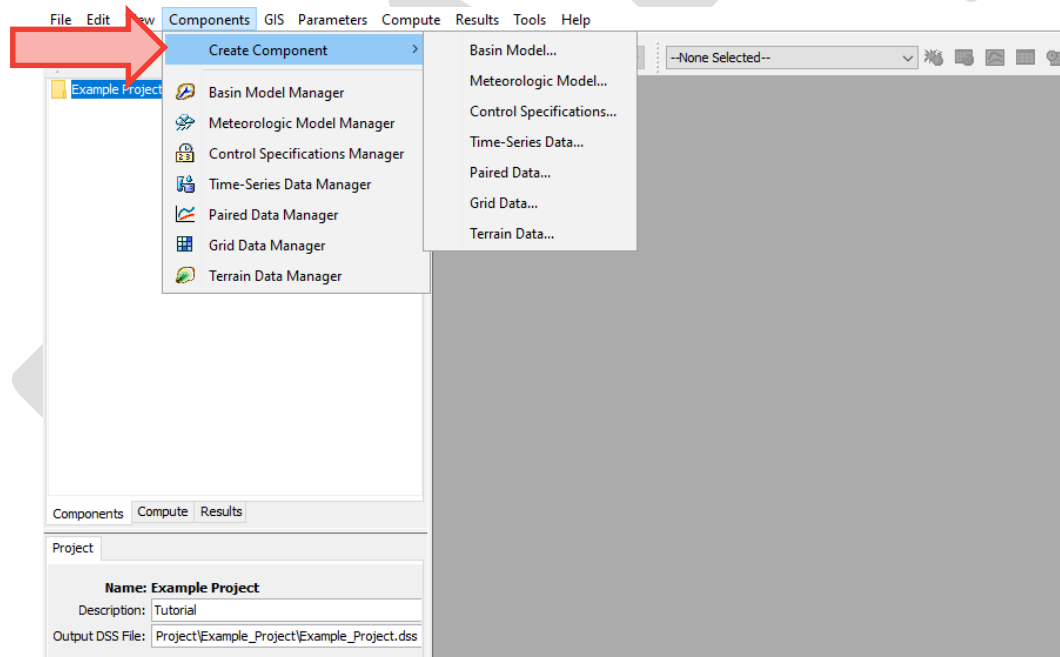
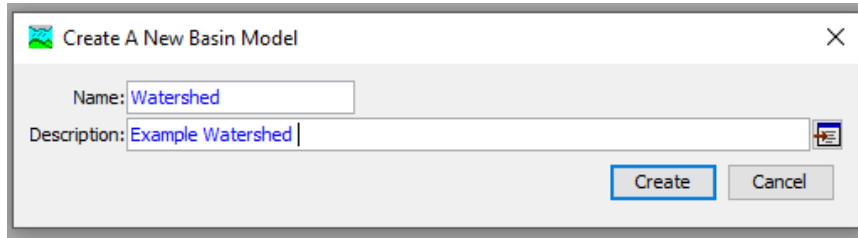

Figure 5- 4: Creating Components

1. New Basin Model:

**Components > Create Component > Basin Model**

This Basin Model will contain the watershed that is being modeled. This will create a folder in the Watershed Explorer that has the name assigned to this basin. The 5.3 Input Data section will explain how to add hydrologic parameters to the various hydrologic parameters.

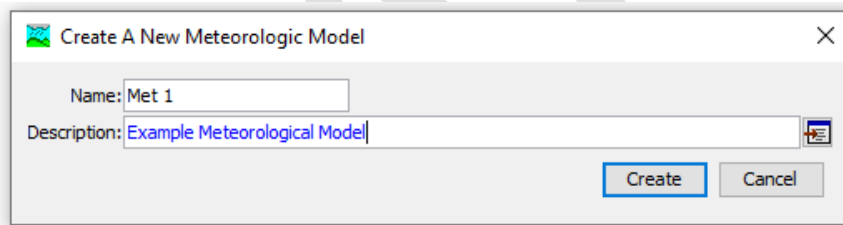

*Figure 5- 5: Creating a New Watershed Basin*

2. New Meteorological Model:

**Components > Create Component > Meteorological Model**

This is where rainfall data will be implemented that the project will use. The Meteorologic Model section will explain how to input rainfall data.

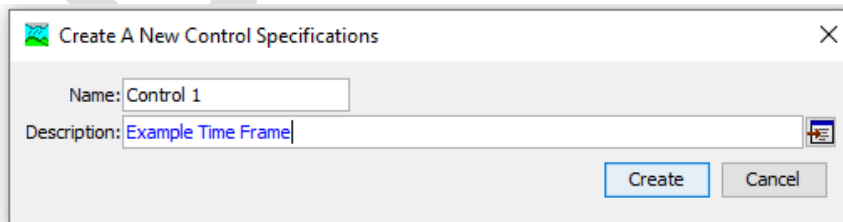

*Figure 5- 6: Creating a New Meteorological Model*

3. New Control Specification:

**Components > Create Component > Control Specifications.**

The Control Specification section will explain how to input a time for the model to run.



*Figure 5- 7: Creating a New Control Specification*

At this point, the Watershed Explorer should show all the folders that have been created by adding the new components. See Figure 5- 8 as an example:

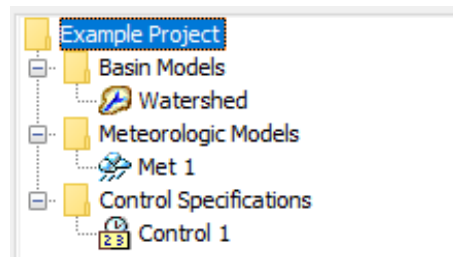

**Figure 5- 8: Watershed Explorer Example**

If additional components are required such as a time series data (which allows the user to select from a range of different gage sets to track atmospheric conditions), paired data (which allows the user to route ponds), Grid Data (which provides a range of atmospheric gridded conditions), or Terrain Data (which allows that model to be geospatially referenced), then these components will be contained within the same folder. Again, these steps are not necessary to add to make the model run, they are only applicable to projects in which these steps are required. The creation of paired data is explained in the Paired Data section.

### 5.3 INPUT DATA

There is different hydrologic elements that can be used to create a project representing the study area. These elements as shown in Figure 5- 9, in order of the photo, represent subbasin, reach, reservoir, junction, diversion, source and sink.

Hydrologic Elements include:

- Subbasin: Represents the physical watershed
- Reach: Convey stream flow downstream in the basin model. Inputs can come from one or more upstream elements.
- Reservoir: Models the detention and attenuation of a hydrograph caused by a reservoir or detention pond
- Junction: Combines stream flow from hydrologic elements located upstream
- Diversion: Modeling stream flow leaving the main channel
- Source: Introduces flow into the basin model
- Sink: Represents the outlet of the physical watershed



**Figure 5- 9: Hydrologic Elements in HEC-HMS Toolbar**

### 5.3.1 Basin Model

1. Click the first blue symbol on the tool bar to create a subbasin.

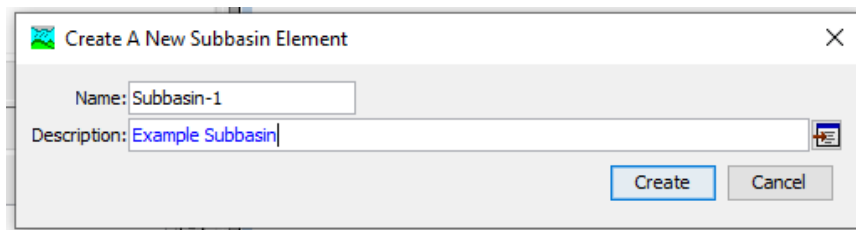
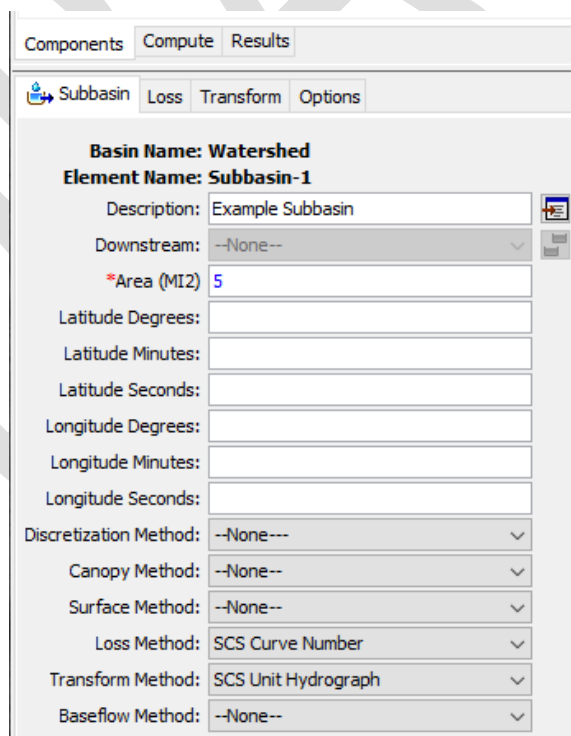

*Figure 5- 10: Creating a New Subbasin*

#### Input Parameters for HEC-HMS:

Click on the hydrologic element and enter the data that represents the subbasin. Each tab, Subbasin, Loss, Transform and Options all have different input parameters. The parameters that should stay the same for each project include:

1. **Discretization Method: None**
2. **Canopy Method: None**
3. **Surface Method: None**
4. **Loss Method: SCS Curve Number**
5. **Transform Method: SCS Unit Hydrograph**
6. **Base Flow: None**

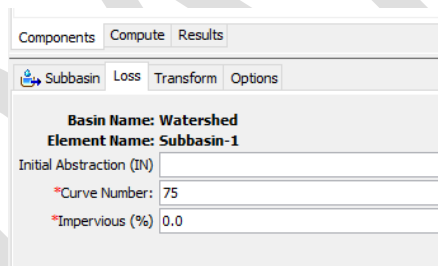

*Figure 5- 11: Subbasin Input Parameters*

The input parameters that have been included in Figure 5- 12 through Figure 5- 15 have been entered for the purpose of this example. These will need to be calculated for each subbasin, utilizing the guidance stated below.

### 5.3.1.1 Curve Number

- Soil Data can be downloaded from the NRCS Web Soil Survey website. <https://websoilsurvey.sc.egov.usda.gov/App/WebSoilSurvey.aspx>
- The data available on the NRCS website is representative of virgin in situ soil conditions. The data does not reflect on whether the soils have been affected by development. This data is not updated regularly. Therefore, it is important to understand how certain areas have developed relative to the data provided by the NRCS.
- Curve numbers will be based on Soils and Land Use and shall be determined from the methods prescribed in the NRCS Document TR-55. Pgs. 2-5 through 2-8. For existing conditions model development, if the subbasin is in a developed area such as a subdivision, commercial, or business area, Hydrologic Soil Group C shall be assumed regardless of the NRCS Web Soil Survey data to account for compaction and importing of fill material.
- **Curve Numbers shall be reported as whole numbers, no tenths.**



Basin Name: Watershed	
Element Name: Subbasin-1	
Initial Abstraction (IN)	
*Curve Number:	75
*Impervious (%)	0.0

Figure 5- 12: Subbasin Loss Input Parameters

### 5.3.1.2 Graph Type

- According to Technical Note No. 4, Peak Rate Factor (PRF) represents the ratio of runoff under the rising limb of the unit hydrograph to the total base time (USDA-NRCS 2016), which changes the shape of the hydrograph without altering the total runoff volume. The default PRF in HEC-HMS is 484, which means that the rising side of the limb is 37.5% of the total runoff volume. Flatter watersheds tend to have lower PRF's whereas steeper watersheds tend to have higher PRF's. Therefore, mountainous streams will have PRF's closer to that of 600 as stated in Chapter 15 of the National Engineering Handbook, Part 630, Hydrology (USDA-NRCS 2010).
- Options include: 100, 150, 200, 250, 300, 350, 400, 450, 500, 550, 600, Standard (PRF 484) and Delmarva (PRF 284)
- **The standard PRF 484 should be used, unless there is a basin that requires a different factor based on topography**

### 5.3.1.3 Lag Time

- Use of the SCS unit hydrograph is prescribed and the transform input as Basin Lag, in minutes.
- Basin Lag is a function of the Time of Concentration ( $T_{Lag} = 0.6 T_c$ ).
- $T_c$  is defined as the longest flow path (watercourse), or time required for water to travel from the most hydraulically remote point in a subbasin to the point of interest or the outlet of the subbasin.
- $T_c$ : shall be computed using the Velocity Method.
- The time of concentration can be calculated using the Velocity method, those described in the TR-55 Document, where  $T_c = t_{sheet} + t_{shallow} + t_{channel}$  utilizing Mannings values (pages 3-1 through 3-4). <https://directives.sc.egov.usda.gov/OpenNonWebContent.aspx?content=39877.wba>

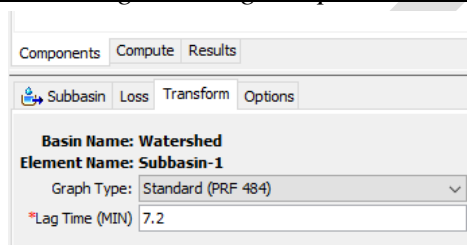

Components	
Subbasin	Loss
Transform	Options

**Basin Name:** Watershed  
**Element Name:** Subbasin-1

Graph Type: Standard (PRF 484) ▼

\*Lag Time (MIN) 7.2

Figure 5- 13: Subbasin Transform Input Parameters

### 5.3.1.4 Bulking Factor

A flow ratio represents sediment delivery associated with storm runoff. This helps to determine how much sediment movement will occur when modeling the subbasins. Several modeling studies for areas in the semi-arid southwest and on alluvial fans apply a bulking factor (ratio of sediment-bulked discharge to clear-water discharge) to the runoff hydrograph to represent sediment-laden water; often applied as a flow ratio to each subbasin within the range of 1.06 to 1.20 (USDA-NRCS, 2016 and Mussetter Engineering Inc., 2008). For developed areas, a bulking factor of 6% or 1.06 shall be used. For undeveloped areas, a bulking factor of 18% or 1.18 shall be used.

#### Input Parameters for HEC-HMS:

To ensure that the Flow Ratio setting is turned on, click on the Basin Model icon (the folder that houses all the watershed components), Figure 5- 14. Then enter the sediment ratio in the options tab on the subbasin, Figure 5- 15. If the sediment bulking factor is 6% it will need to be entered in the form of 1.06, 10% = 1.10, 15%=1.15, etc.)

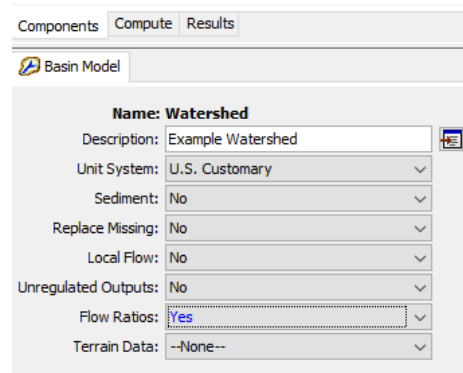

Figure 5- 14: Turning on Sediment Bulking Factors

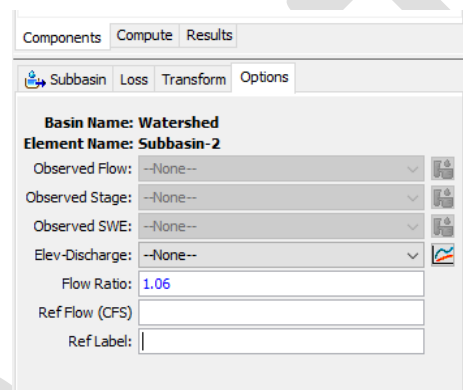

Figure 5- 15: Subbasin Options Input Parameters

### 5.3.1.5 Routing

To route hydrographs through the system, a reach will need to be created as expressed in Figure 5- 16. This is done by selecting the second blue icon on the tool bar. This will apply a blue line between two subbasins as shown in Figure 5- 17.

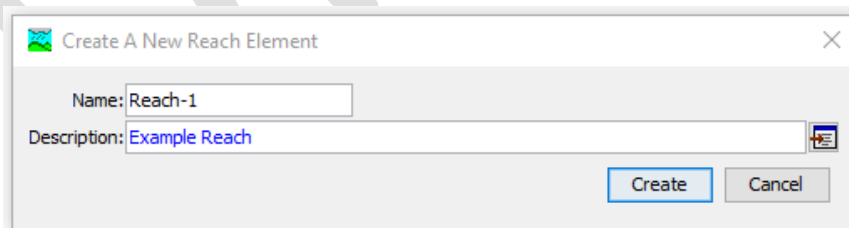
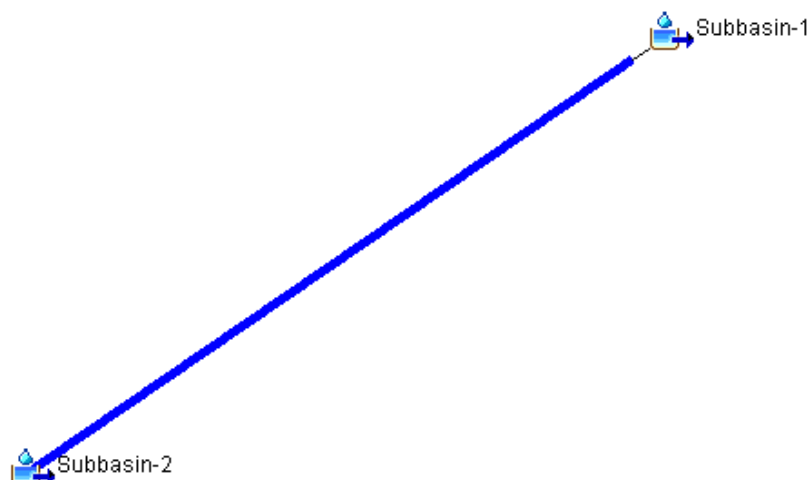

Figure 5- 16: Creating a Routing Reach

When selecting the blue line on the desktop watershed window, the reach editor will pop up that allows the user to enter parameters to route hydrographs. Be sure to select the appropriate downstream connections for all the elements in the watershed.



**Figure 5- 17: Routing Reach Desktop Image**

**Input Parameters for HEC-HMS:**

1. **Routing Method: Muskingum-Cunge**
2. **Loss/Gain Method: None**

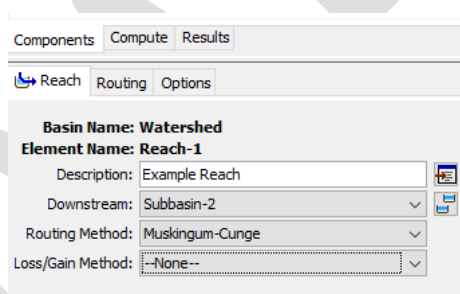

**Figure 5- 18: Routing Reach Input Parameters**

On the Routing tab, the user can choose what the routing method looks like. This may transition between a storm drain, to a natural channel, to a lined concrete channel. These will be signified by choosing a Length, Slope, Mannings, Shape and any channel geometry that goes along with this.

**Input Parameters for HEC-HMS:**

1. **Initial Type: Discharge= Inflow**
2. **Space- Time Method: Auto DX Auto DT (This allows the program to automatically select space and time intervals that maintain numeric stability)**
3. **Index Method: Flow**

The index flow tells the model how to route hydrographs through the system. Experience has shown that a reference flow based upon average values of the hydrograph in question (i.e., midway between the base flow and the peak flow) is, in general, the most suitable choice. When the index flow is near the peak flow



the model tends to numerically accelerate the hydrograph wave much more than what would occur in nature. The same is true if the reference flow is too low, it will send the wave much slower than what would occur in nature.

The index flow is determined by taking all upstream flow that contributes to this routing reach and dividing by two. At the beginning, any number can be input so that the model will run. The user will then need to go back and look at this node in the results to apply the correct upstream flow. The user will then work their way down the watershed, starting with the hydrologic symbol that is the farthest upstream ending at the outlet. Failure to correctly specify the index flow will create instability in the routing reach and potentially create incorrect flows at the downstream junction.

Basin Name: Watershed	
Element Name: Reach-1	
Initial Type:	Discharge = Inflow
*Length (FT)	6042
*Slope (FT/FT)	0.072
*Manning's n:	0.06
Space-Time Method:	Auto DX Auto DT
Index Method:	Flow
*Index Flow (CFS)	350.05
Shape:	Circle
*Diameter	5
Invert (FT)	

Figure 5- 19: Routing Reach Input Parameters

### 5.3.2 Meteorologic Model

Data download:

- Rainfall data can be found at NOAA's website using their frequency data server: [http://hdsc.nws.noaa.gov/hdsc/pfds/pfds\\_map\\_cont.html?bkmrk=nm](http://hdsc.nws.noaa.gov/hdsc/pfds/pfds_map_cont.html?bkmrk=nm)
- The study point should be placed at the centroid of the watershed.
- When submitting models, submit a hard copy (print or pdf) of precipitation to document the values used. Values are updated on the data server (NOAA updates the storm library from time to time).

### Input Parameters for HEC-HMS

1. **Unit System: U.S Customary**
2. **Shortwave: None**
3. **Longwave: None**
4. **Precipitation Distribution: Frequency Storm**
5. **Evapotranspiration: None**
6. **Snowmelt: None**
7. **Replace Missing: Abort Compute**

8. Ensure that all the Meteorological Model basins are turned on (Figure 1- 21)

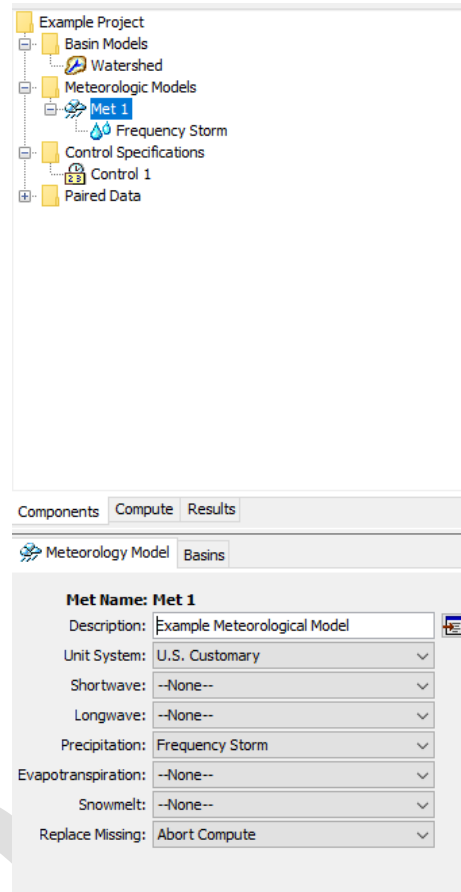

Figure 5- 20: Meteorological Model Input Parameters

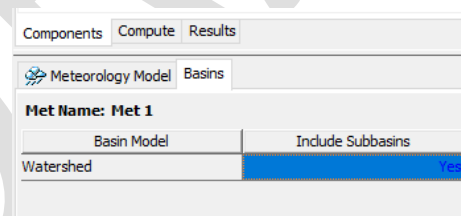

Figure 5- 21: Meteorological Modeling Basins

**Input Parameters for HEC-HMS:**

1. Storm Type: NA
2. Annual-Partial Conversion: None
3. Annual Partial Ratio: 1.0 (automatically assigned value)
4. Storm Duration: Value set by local requirements – 24 hours is typical
5. Intensity Duration: 5 minutes
6. Intensity Position: 25%

7. Area Reduction: None
8. Curve: Uniform for All Subbasins

The screenshot displays the HEC-HMS software interface for configuring a Frequency Storm. The project tree on the left shows the following structure:

- Example Project
  - Basin Models
    - Watershed
  - Meteorologic Models
    - Met 1
      - Frequency Storm (selected)
  - Control Specifications
    - Control 1
  - Paired Data

The main configuration panel for the selected 'Frequency Storm' includes the following parameters:

- Met Name:** Met 1
- Storm Type:** HYDRO35 TP40 TP49
- Annual-Partial Conversion:** --None--
- Annual-Partial Ratio:** 1.00
- Storm Duration:** 1 Day
- Intensity Duration:** 5 Minutes
- Intensity Position:** 50 Percent
- Area Reduction:** --None--
- Curve:** Uniform For All Subbasins

Below the parameter list are two tables:

Duration	Depth (IN)
5 Minutes	0.64
15 Minutes	1.20
1 Hour	2.01
2 Hours	2.39
3 Hours	2.49
6 Hours	2.73
12 Hours	3.09
1 Day	3.81
2 Days	
4 Days	
7 Days	
10 Days	

Figure 5- 22: Frequency Storm Input Parameters

### 5.3.3 Control Specification

#### Input Parameters for HEC-HMS:

- Control specifications should always have a name that includes the duration, time step (24hr 5-min), and any additional details if seasonal modeling is going to occur (monsoon season vs spring).
- Start date should always be the year of the project (the month is not important unless modeling a specific event).

- Entering control specifications should always start at 00:00 for the Start Time and end at 00:00 for a duration that is long enough to capture the entirety of the event (for instance a modeled pond or reservoir should be completely drained before ending the control time). The start/end time must be written in a form of DDMMYYYY (12JAN2020 for example).
- **Time interval should 2 minutes or less to ensure the peak flows are captured. Shorter times can be used when dealing with small Tc's for basins.**

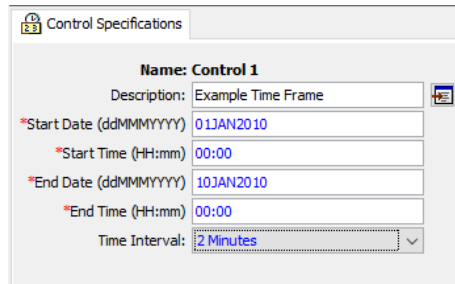

The screenshot shows a dialog box titled "Control Specifications". It contains the following fields:

- Name: Control 1
- Description: Example Time Frame
- \*Start Date (ddMMYYYY): 01JAN2010
- \*Start Time (HH:mm): 00:00
- \*End Date (ddMMYYYY): 10JAN2010
- \*End Time (HH:mm): 00:00
- Time Interval: 2 Minutes (selected from a dropdown menu)

Figure 5- 23: Example Control Specifications

A note about the time steps - HEC-HMS automatically adjusts the time steps within the model if there is a need for it, however what is reported out is what the user specifies, for additional information, please see the HEC-HMS User's Manual

### 5.3.3.1 Paired Data

Paired data allows the model to know what the reservoir looks like. Creation of three paired data sets will need to be created: Storage Discharge Functions, Elevation Storage Functions and Elevation Discharge Functions. A description of each of these are below.

- Storage Discharge Functions: A storage-discharge function computes the amount of outflow for a specific amount of storage in the reach.
- Elevation Storage Functions: Elevation storage function computes the elevation and storage for each time interval.
- Elevation Discharge Functions: Elevation discharge function defines an elevation versus discharge, also known as a rating curve.

### Input Parameters for HEC-HMS:

1. **Components > Create Component > Paired Data.** On the window that pops up, the drop-down bar will allow the user to transfer between each of the functions. Refer to Figure 5- 24 through Figure 5- 26.

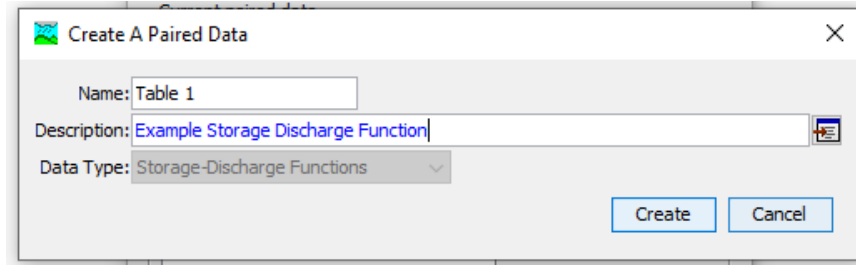

**Figure 5- 24: Adding Storage Discharge Functions**

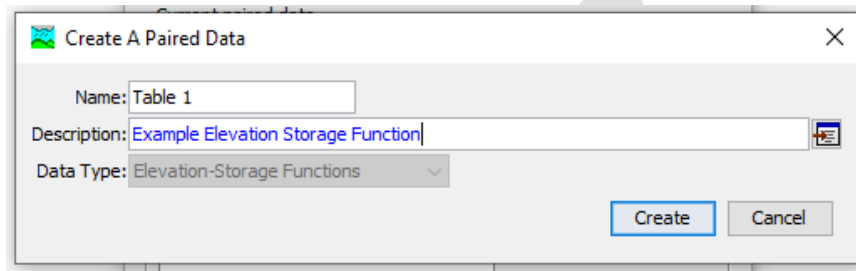

**Figure 5- 25: Adding Elevation Storage Function**

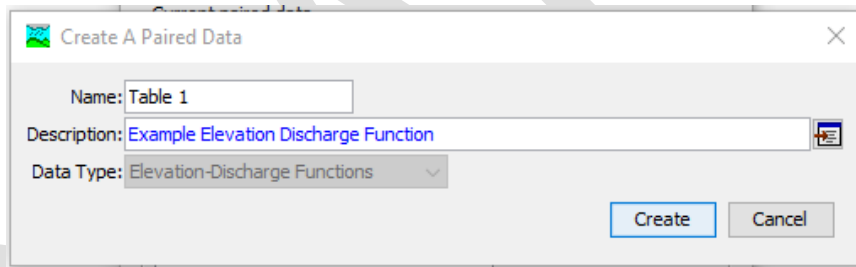

**Figure 5- 26: Adding Elevation Discharge Function**

To add data to each of these tables, expand the Paired Data folder in the watershed explorer window which houses all the functions that were previously created (Figure 5- 27). From here the user can manually add data to the function.



**Figure 5- 27: Paired Data Functions**

**Input Parameters for HEC-HMS:**

1. **Data Source: Manual Entry**
2. **Units: ACRE-FT : CFS**

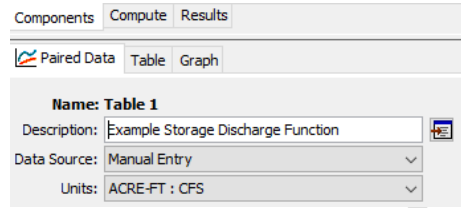

**Figure 5- 28: Paired Data Input Parameters**

Data can be entered or edited in each cell of the table in HEM-HMS, under the Table tab.

Storage (ACRE-FT)	Discharge (CFS)
0.00	0.0
12.00	240.2
34.00	355.7
59.00	435.7
86.00	503.1
116.00	562.4

**Figure 5- 29: Paired Data Table Input Parameter**

The Graph tab shows what the data entered into the Table on the previous tab will look like.

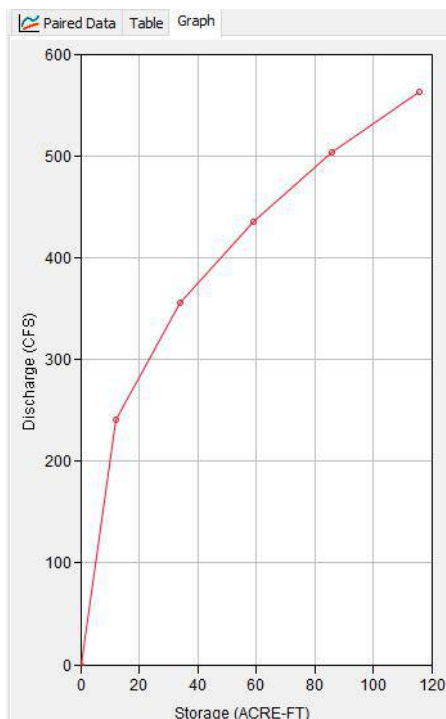

Figure 5- 30: Paired Data Graph

### 5.3.3.2 Reservoir

If a pond or dam is part of the project, the user will be required to add a reservoir.

#### Input Parameters for HEC-HMS:

1. Click the third blue icon on the tool bar
2. Name the reservoir
3. Add an optional description for the reservoir
4. To connect the reservoir, right click on the element upstream that will be connected to the reservoir and select "Connect Downstream"

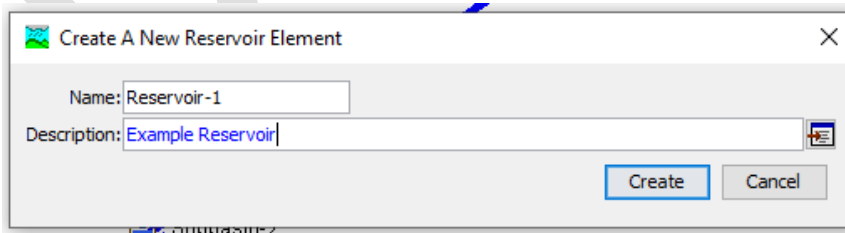
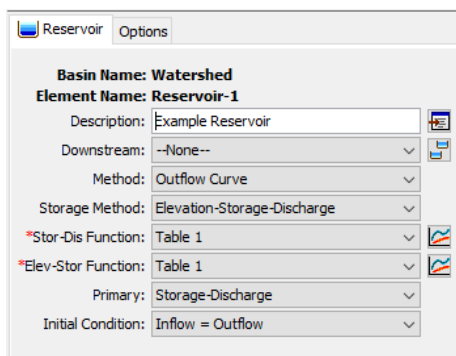

Figure 5- 31: Creating a New Reservoir

To add data to the reservoir that was created, click the icon and an editor tab should pop up that allows the user to choose the appropriate paired data tables to connect to the reservoir.

**Input Parameters for HEC-HMS:**

1. **Method: Outflow curve**
2. **Storage Method: Elevation-Storage-Discharge**
3. **Primary: Storage Discharge**
4. **Initial Condition: Inflow = Outflow**



*Figure 5- 32: Reservoir Input Parameters*

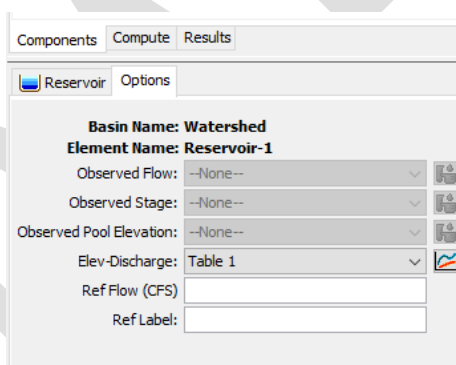

*Figure 5- 33: Reservoir Options Input Parameters*

At this point in the process, the watershed explorer should showcase all the elements that were added to the model. Figure 5- 34 and Figure 5- 35 shows a representation of both the watershed explorer and desktop view.



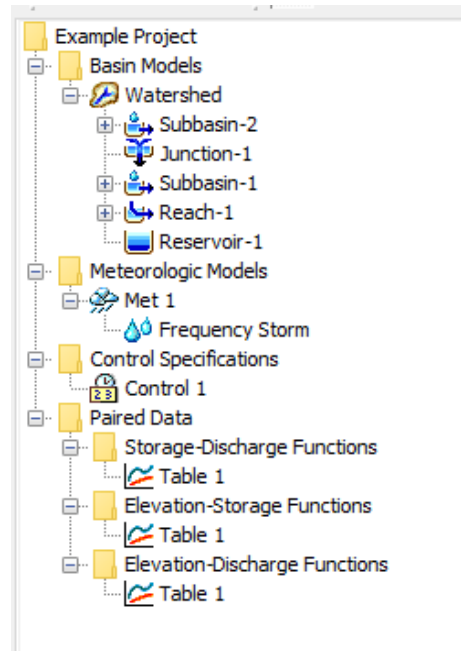

Figure 5- 34: Example of Complete Watershed Explorer

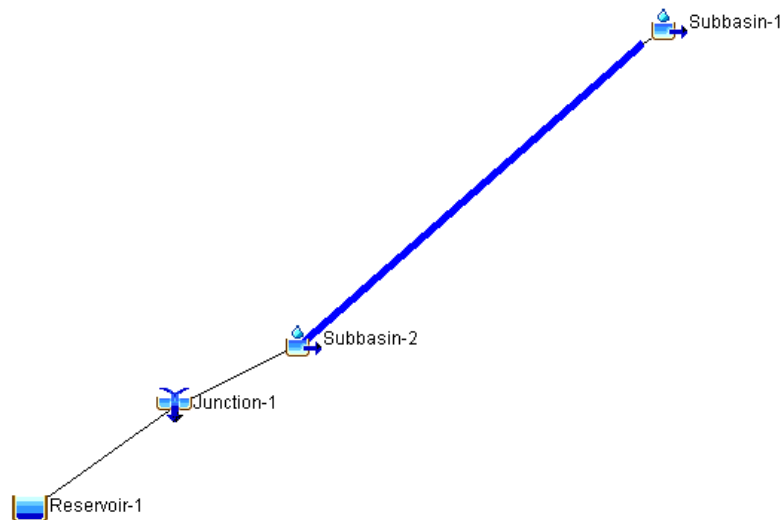

Figure 5- 35: Example of Desktop Window

## 5.4 CREATE COMPUTATION RUN

Once the model has been built, simulation runs will need to be created to run the model.

## Input Parameters for HEC-HMS:

### 1. Compute > Create Compute > Simulation run

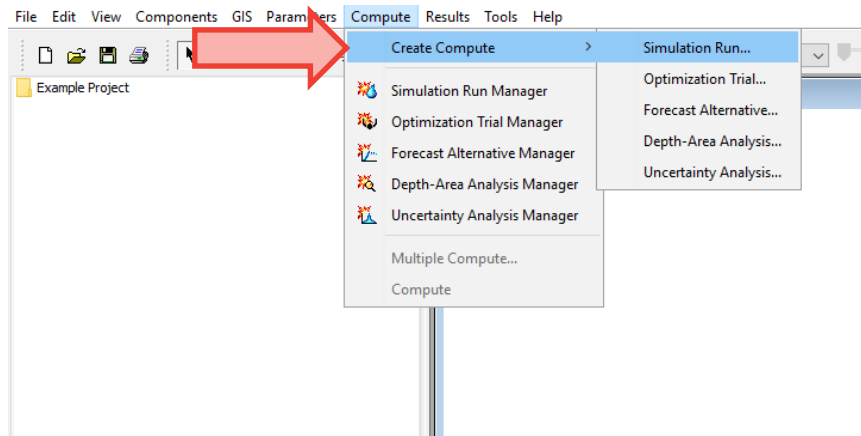

*Figure 5- 36: Creation of New Simulation Run*

From here a window will pop up that will have four steps. If there are multiple watersheds/ meteorological models and or time frames, this is where the user will be able to select the specific options.

### 2. Name the simulation run

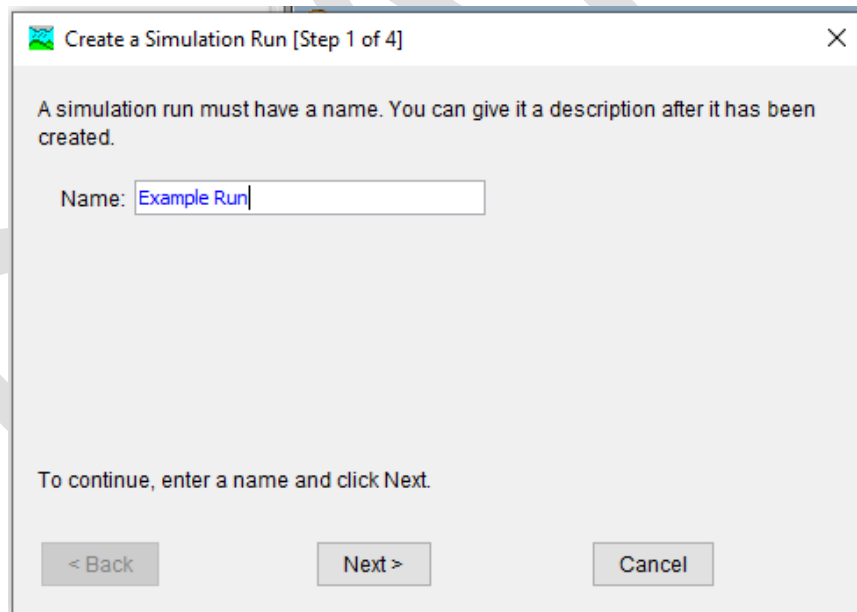

*Figure 5- 37: Step One of Simulation Run*

3. Choose the watershed that is being modeled

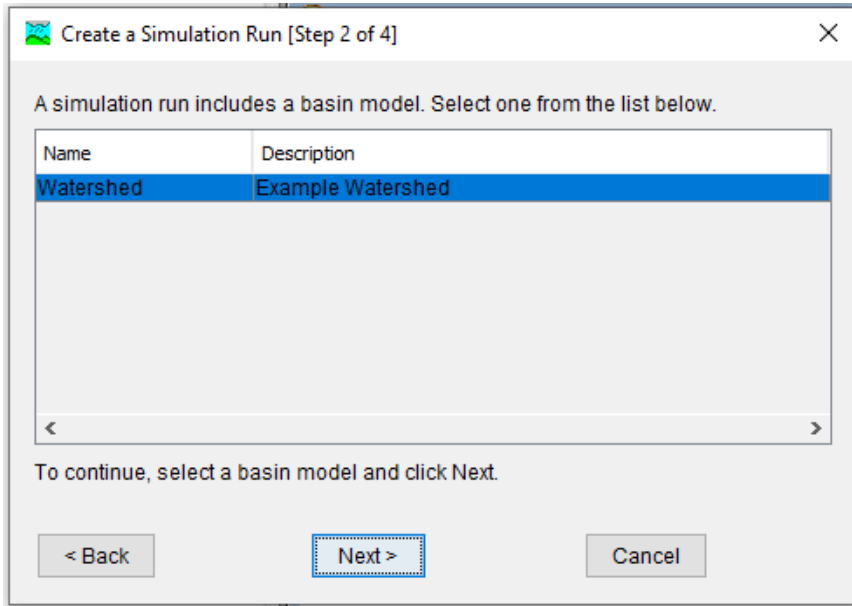

Figure 5- 38: Step Two of Simulation Run

4. Choose the met model that will be ran with this watershed

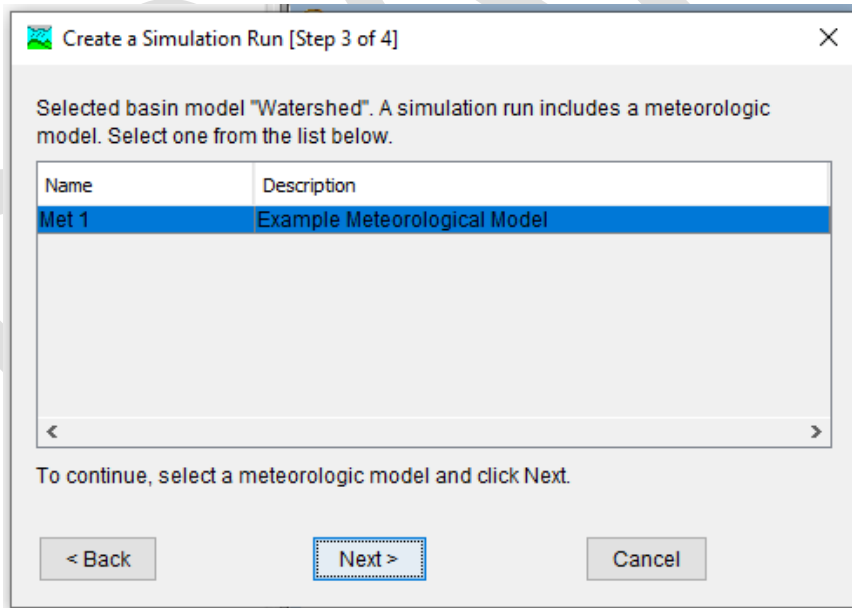
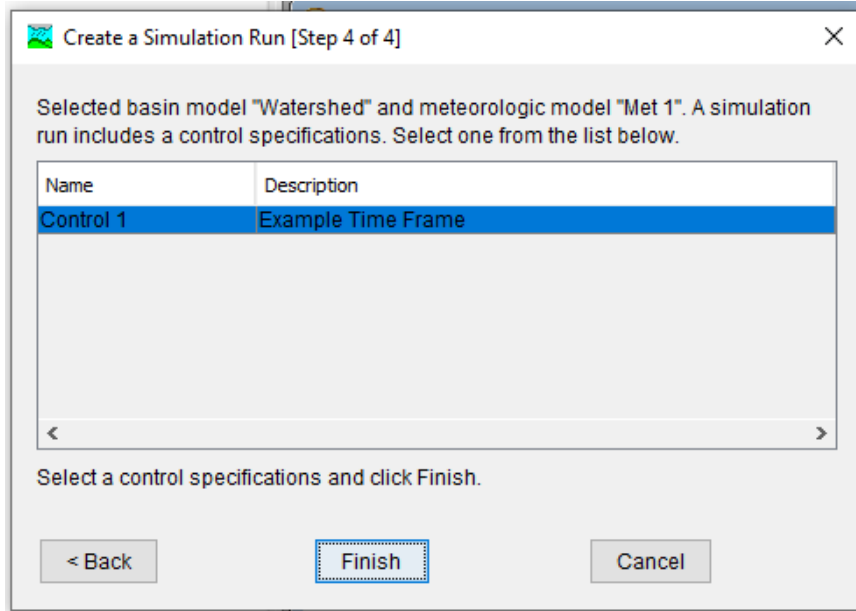

Figure 5- 39: Step Three of Simulation Run

5. Choose a time frame and hit finish.



*Figure 5- 40: Step Four of Simulation Run*

This will create a simulation run that will pop up in the compute tab of the watershed explorer.

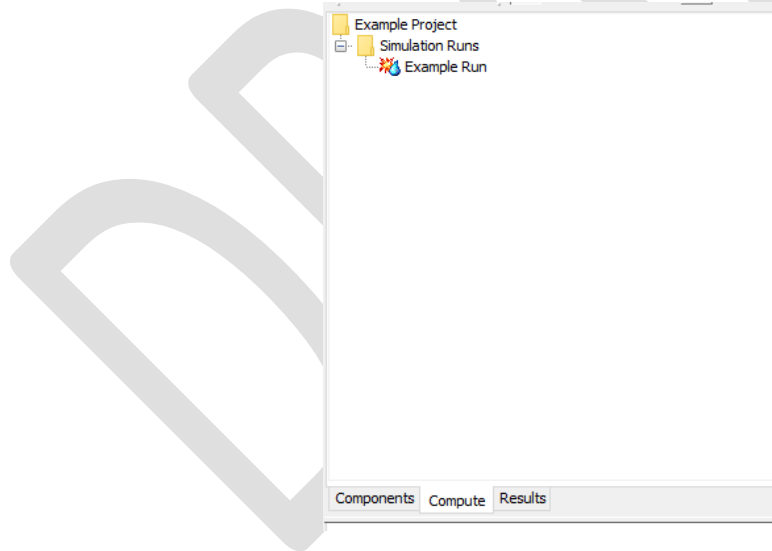
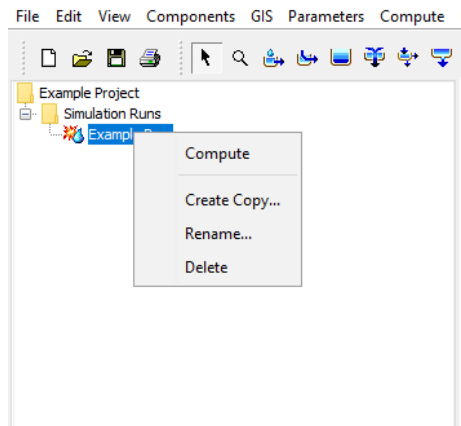

*Figure 5- 41: Example of Simulation Run*

To run the model, either hit the symbol that should now light up in the toolbar as represented in Figure 1-42 or right click the example run in the watershed explorer and hit run Figure 5- 43.

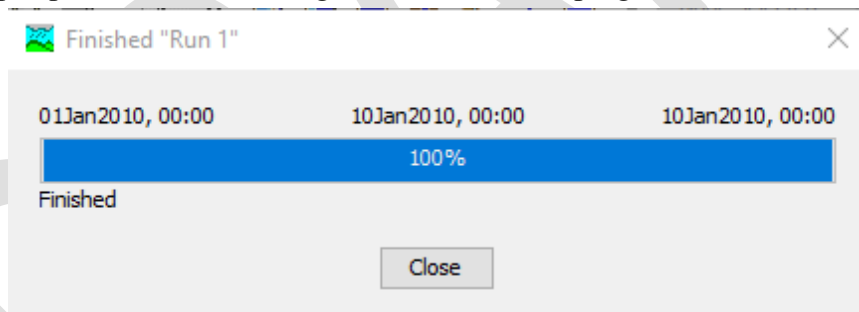

**Figure 5- 42: Compute Icon in Toolbar**



**Figure 5- 43: Another Option to Run Model**

A progress bar pops up on the screen letting the user know the progress of the model (Figure 5- 44).



**Figure 5- 44: Progress Bar**

## 5.5 RESULTS

Once the model has run, and there are no errors, the results tab will fill with data populated under the run tab that was created (Figure 5- 45).



*Figure 5- 45: Creation from Results*

The global summary table will report each hydrologic elements peak discharge, time of peak and volume (Figure 5- 46).

Project: Example Project    Simulation Run: Example Run

Start of Run: 01Jan2010, 00:00    Basin Model: Example Watershed  
 End of Run: 10Jan2010, 00:00    Meteorologic Model: Met 1  
 Compute Time: 22Dec2021, 10:38:04    Control Specifications: Control 1

Show Elements: All Elements    Volume Units:  IN  ACRE-FT    Sorting: Hydrologic

Hydrologic Element	Drainage Area (MI <sup>2</sup> )	Peak Discharge (CFS)	Time of Peak	Volume (ACRE-FT)
Subbasin-1	0.1408	55.3	01Jan2010, 06:32	6.6
Subbasin-2	0.1532	46.4	01Jan2010, 06:38	6.4
Junction-1	0.1532	46.4	01Jan2010, 06:38	6.4
Reservoir-1	0.1532	27.9	01Jan2010, 07:04	6.4
Reach-1	0.1408	55.0	01Jan2010, 06:42	6.6

**Figure 5- 46: Global Results Table**

Once each hydrologic element is selected from the list, the tables provide more detailed information on each element (Figure 5- 47).

- Example Project
  - Simulation Runs
    - Example Run
      - Global Summary
      - Subbasin-1
        - Graph
        - Summary Table
        - Time-Series Table
        - Outflow
        - Cumulative Outflow
        - Precipitation
        - Cumulative Precipitation
        - Soil Infiltration
        - Excess Precipitation
        - Cumulative Excess Precipitation
        - Precipitation Loss
        - Cumulative Precipitation Loss
        - Direct Runoff
        - Baseflow
      - Subbasin-2
      - Junction-1
      - Reservoir-1

**Figure 5- 47: Detailed Lists for Each Hydrologic Element**



CITY OF EL PASO

APPENDIX 6

**HEC- RAS TUTORIAL**



## CONTENTS

---

APPENDIX 6. HEC-RAS PROJECT INFORMATION .....	1
6.1 Introduction to HEC-RAS .....	1
6.2 Interface Information.....	2
6.3 Process of Creating an HEC-RAS Project.....	2
6.4 Project set up .....	3
6.4.1 Starting a New Project.....	3
6.4.2 Creation of Geometric Data .....	4
6.4.3 Defining Projects Coordinate System .....	6
6.5 General Guidelines.....	10
6.5.1 Delineation of Stream Reach and Cross Sections.....	10
6.5.2 Guidelines for Locating and Delineating Channel Cross Sections.....	12
6.5.3 Example of Cross-Sectional Data.....	12
6.5.4 Cross Section Geometry .....	14
6.6 Structures.....	15
6.6.1 Incorporating Bridges.....	15
6.6.2 Bridge Editor.....	16
6.6.3 Culvert Data Editor.....	20
6.7 Viewing Results.....	21
6.7.1 Channel Profile.....	22
6.7.2 Water Surface.....	23
6.8 Post Run Results.....	25

## LIST OF FIGURES

---

Figure 6- 1: HEC-RAS Interface .....	2
Figure 6- 2: HEC-RAS Interface Icon Descriptions.....	2
Figure 6- 3: Project Location.....	3
Figure 6- 4: Units Classification Pop Up.....	4
Figure 6- 5: Creation of Geometric Data.....	4
Figure 6- 6: Geometric Data Window .....	5
Figure 6- 7: New Geometry Data .....	5
Figure 6- 8: Location of Geometry Data.....	6
Figure 6- 9: Launch RAS- Mapper .....	6
Figure 6- 10: Setting Coordinate System.....	7
Figure 6- 11: Setting Projection .....	7
Figure 6- 12: Project Projection Details.....	8
Figure 6- 13: Web Imagery Layers .....	8
Figure 6- 14: RAS Terrian Data.....	9
Figure 6- 15: RAS Aerial Imagery.....	9
Figure 6- 16 : Stream Cross Section.....	11
Figure 6- 17: Profile of Stream Reach Data .....	12
Figure 6- 18: Natural Arroyo Changing Flow Path Geometry .....	13
Figure 6- 19: Natural Arroyo Corresponding Cross Sections.....	13
Figure 6- 20: Cross Section Editor.....	14
Figure 6- 21: Bridge Cross Section Plan View .....	15
Figure 6- 22: Bridge Editor Button in Geometry Editor.....	16
Figure 6- 23: Bridge Editor.....	17
Figure 6- 24: Bridge Deck and Roadway Editor .....	18
Figure 6- 25: Pier Data Editor.....	19
Figure 6- 26: Pier Data .....	20
Figure 6- 27: Culvert Data Editor.....	21
Figure 6- 28: Profile Plot of Stream Reach.....	22

Figure 6- 29: Profile Plot of Cross Section..... 22

Figure 6- 30: Channel Profile in Toolbar ..... 23

Figure 6- 31: Plotted Channel Profile ..... 23

Figure 6- 32: Cross Section Viewer in Toolbar ..... 24

Figure 6- 33: Plotted Cross-Section Profile..... 24

Figure 6- 34: Detailed Output Icon..... 25

Figure 6- 35: Bridge Output ..... 25

Figure 6- 36: RAS Mapper Results Post Run ..... 26

DRAFT

## APPENDIX 6. HEC-RAS PROJECT INFORMATION

---

### 6.1 INTRODUCTION TO HEC-RAS

According to US Army Corps of Engineers, Hydrologic Engineering Center's River Analysis System (HEC-RAS) is designed to allow the user to perform one-dimensional steady flow, one and two-dimensional unsteady flow calculations, sediment transport/mobile bed computations, and water temperature/water quality modeling. HEC-RAS Version 6.1 has the following computational capabilities:

#### Steady flow Calculations

- Intended to calculate water surface profiles for steady gradually varied flow.
- Handle a full network of channels, a dendritic system or even a single river reach.
- Model subcritical, supercritical, and mixed flow regimes.
- Calculations are based on the one-dimensional energy equation.
- Energy losses are evaluated by friction (Mannings Equation) and contraction/expansion (based off the change in velocity head).
- The momentum equation is used in situations where the water surface profile is rapidly varied such as hydraulic jumps, hydraulics of bridges, and river confluences.

#### One- and Two-Dimensional Calculations

- Calculate one-dimensional, two-dimensional, and combined one- and two- dimensional unsteady flow.
- Handle a full network of open channels, floodplains, and alluvial fans.
- Model subcritical, supercritical, and mixed flow regimes.
- Unsteady flow components analyze dam breaks, levee breaching and overtopping, pump stations, pressurized pipe systems, and dam operations.

#### Sediment Transport and Movable Boundary Calculations

- Calculate one-dimensional sediment transport/movable boundary calculations resulting from scour and deposition over moderate time periods.
- Handle a full network of streams, channel dredging, various levee, and encroachment alternatives.
- Computed by grain size fraction.
- This system evaluates deposition in reservoirs, design channel contractions required to maintain navigation depths, predicts the influence of dredging on the rate of deposition, estimates maximum scour during large flood events, and evaluates sedimentation in fixed channels.

#### Water Quality Analysis

- Calculate riverine water quality analysis.
- Calculations are based on the one-dimensional advection-dispersion equation using a control volume approach with a fully implemented heat energy budget which allows modeling water temperature.

## 6.2 INTERFACE INFORMATION



Figure 6- 1: HEC-RAS Interface

- Menu Bar: Different options to view the model that is being ran
- Tool Bar: Where all the information to create a model is located. See Figure 6-2 from the HEC-RAS user manual for a description of each icon.
- Component Editor: All data for the model will be entered here

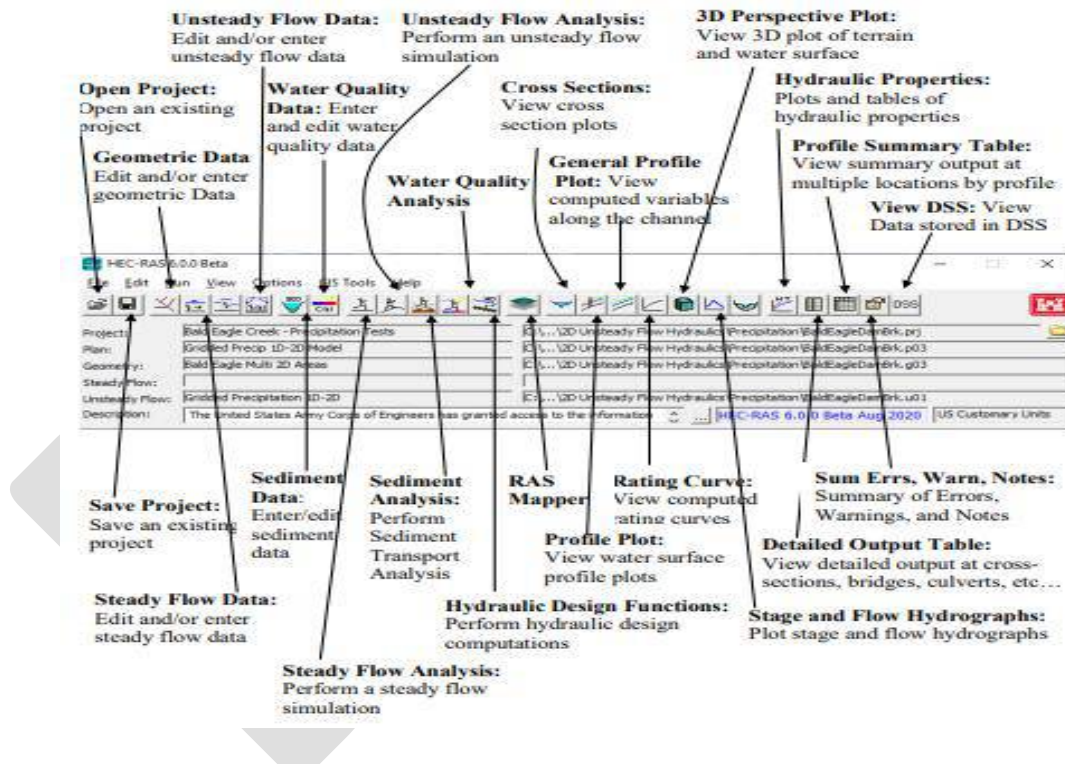

Figure 6- 2: HEC-RAS Interface Icon Descriptions

## 6.3 PROCESS OF CREATING AN HEC-RAS PROJECT

The following sections will provide a step-by-step guide on how to build a HEC-RAS project. If more information on a certain category is required, it is suggested to refer to the HEC-RAS user manuals and guides (for the version that is being used) that are provided on the US Army Corps of Engineers website. The model should be simple enough to be used by reviewers, which includes choosing naming conventions

that makes sense. Text that has been bolded out shows the user what will be common input parameters among all models. The HEC-RAS model should be georeferenced using the appropriate projected coordinate system for El Paso based on where the project is taking place.

A HEC-RAS model must have the following components:

**Terrain Data:** River reach data and cross section data should be derived from regional high-resolution lidar data or design survey data. USGS data at a resolution greater than two meters or 6.3 feet is not acceptable for detailed hydraulic analysis or floodplain mapping. Data required for structures such as bridges and culverts shall be based on as-built information or detailed survey data.

**Geometric Data:** This includes stream reach data, cross section data and any other pertinent information that defines the hydraulic characteristics of the stream reach and channel geometry.

**Steady or Unsteady Flow Data:** Represents flows characteristic of the stream or arroyo that is being studied. Flows may be based on hydrologic modeling done for the tributary watershed, FEMA FIS data or regulatory flows based on approved drainage reports. Any deviations from approved flows will require prior approval from the City of El Paso.

**Boundary Conditions:** Defines the method that the model will use to start its computations. Boundary conditions are applied at the upstream and downstream ends of the river reach.

**Simulation Run:** The model uses plans to identify which geometry files to run with which flow files. It is the model's way of tracking multiple scenarios for geometry and flow.

## 6.4 PROJECT SET UP

### 6.4.1 Starting a New Project

Set up a project in HEC-RAS

#### Input Parameters for HEC-RAS

1. File > New Project
2. Title is the name of the project
3. Choose where the project will be located

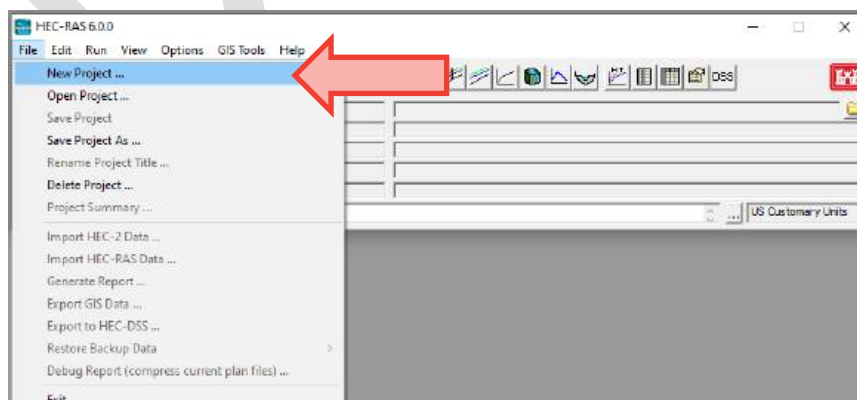

Figure 6- 3: Project Location

A text box will pop up signifying the model will be in US units, **click OK**.

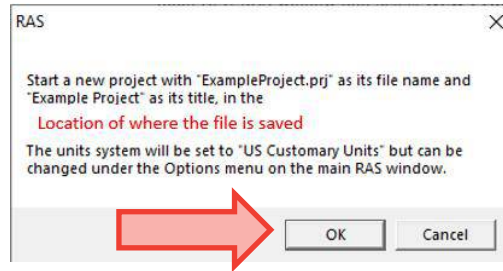

Figure 6- 4: Units Classification Pop Up

### 6.4.2 Creation of Geometric Data

This step requires the input of a connectivity information for the stream system, cross section data, storage areas, two-dimensional flow areas and any hydraulic structure data (bridges, culverts, weirs, etc.)

#### Input Parameters for HEC-RAS

1. Select Geometric Data from the edit menu in the tool bar.

#### Edit> Geometric Data

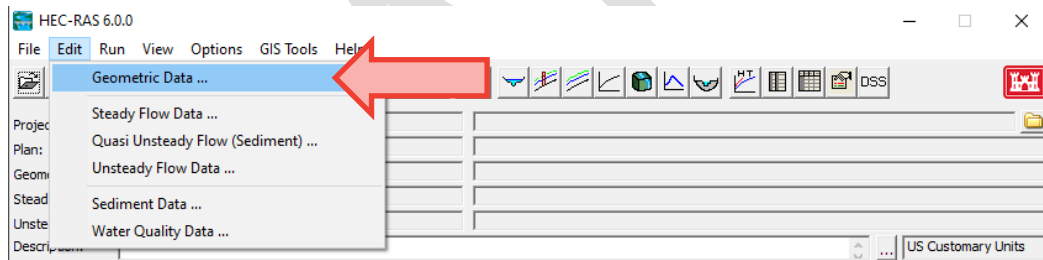

Figure 6- 5: Creation of Geometric Data

2. A new window will pop up, where all geometric data will be entered.

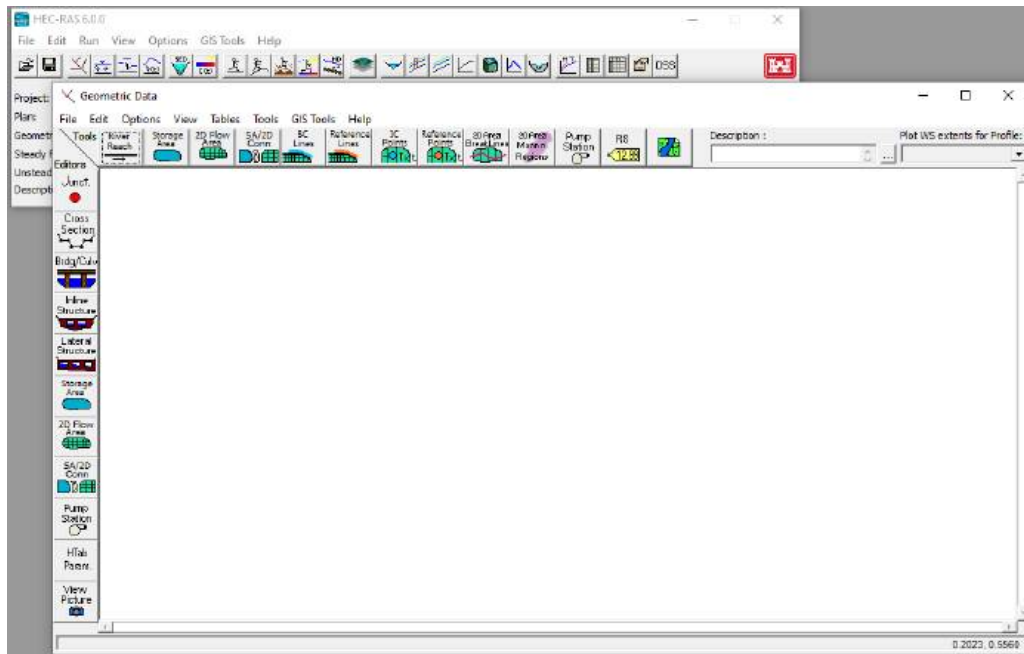

Figure 6- 6: Geometric Data Window

3. From this new window start a new geometry file.

**File> New Geometry Data**

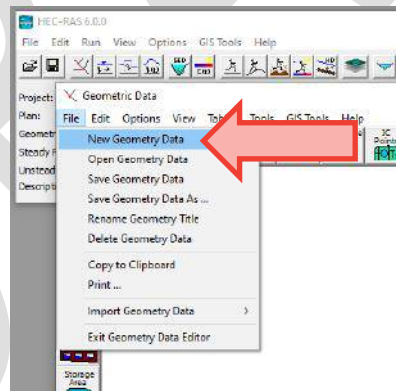

Figure 6- 7: New Geometry Data



4. From here save your new geometry data. Best practices include naming the geometry file the same as your current project.

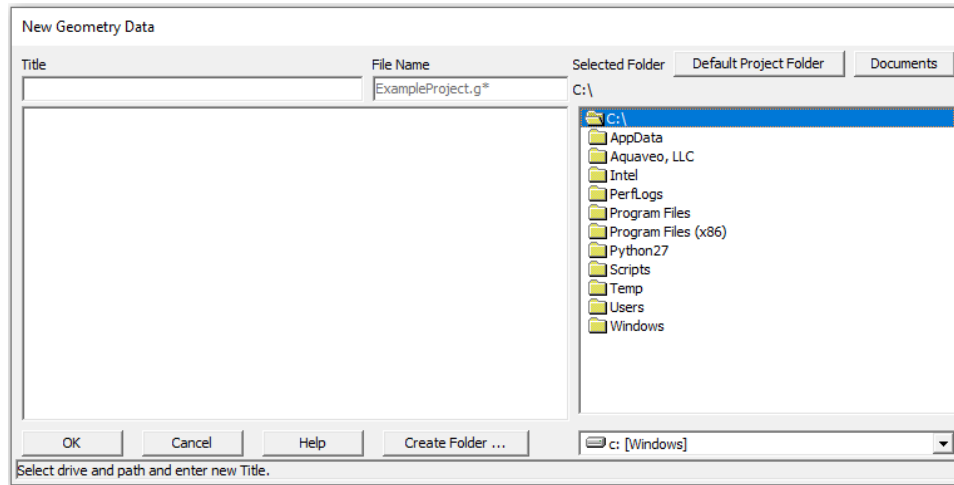

Figure 6- 8: Location of Geometry Data

### 6.4.3 Defining Projects Coordinate System

#### Input Parameters for HEC-RAS

##### 1. Open RAS Mapper

Once the geometry file is created, open RAS Mapper and the geometry file should be visible. RAS Mapper can be launched from the main HEC-RAS menu as shown.

- The RAS Mapper is the graphical user interface used to preprocess terrain, develop river reach data, develop cross sections, and bank stations for the analyzed system. After the model is successful, RAS Mapper can be used to create and view inundation depth and floodplain boundary datasets. Additional geospatial data can be generated for analysis of velocity, shear stress, stream power, ice thickness, and floodway encroachment data can be extracted using RAS Mapper.

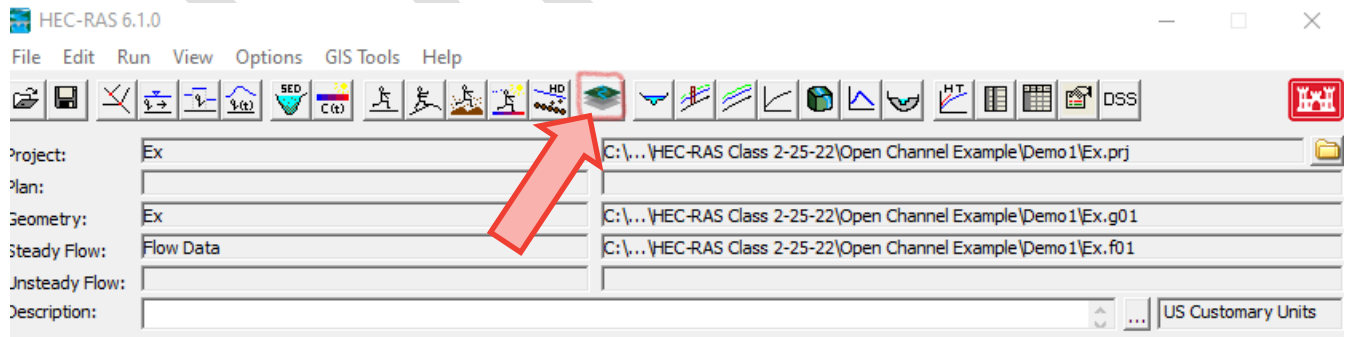

Figure 6- 9: Launch RAS- Mapper

## 2. Choose shape file with correct projection

ArcGIS shapefiles with the correct projection can then be used to define the coordinate system for the project. The shapefile can be added by clicking on the project tab of RAS Mapper.

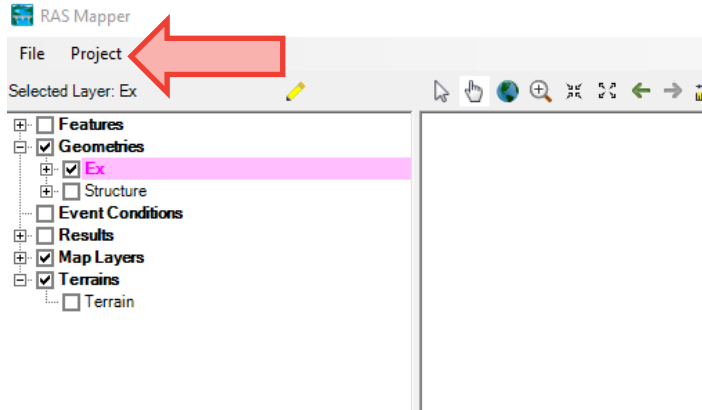

Figure 6- 10: Setting Coordinate System

## 3. Project > Set Projection

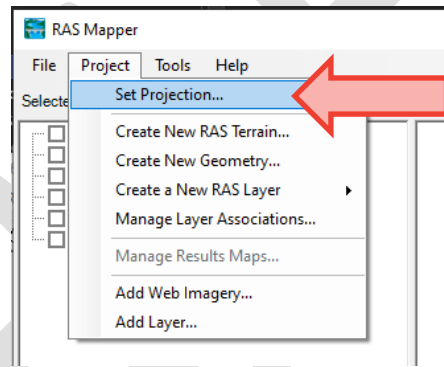

Figure 6- 11: Setting Projection

#### 4. Choose ArcGIS Shapefile

Once correctly defined, the project coordinate definition should be displayed in the dialogue box as shown.

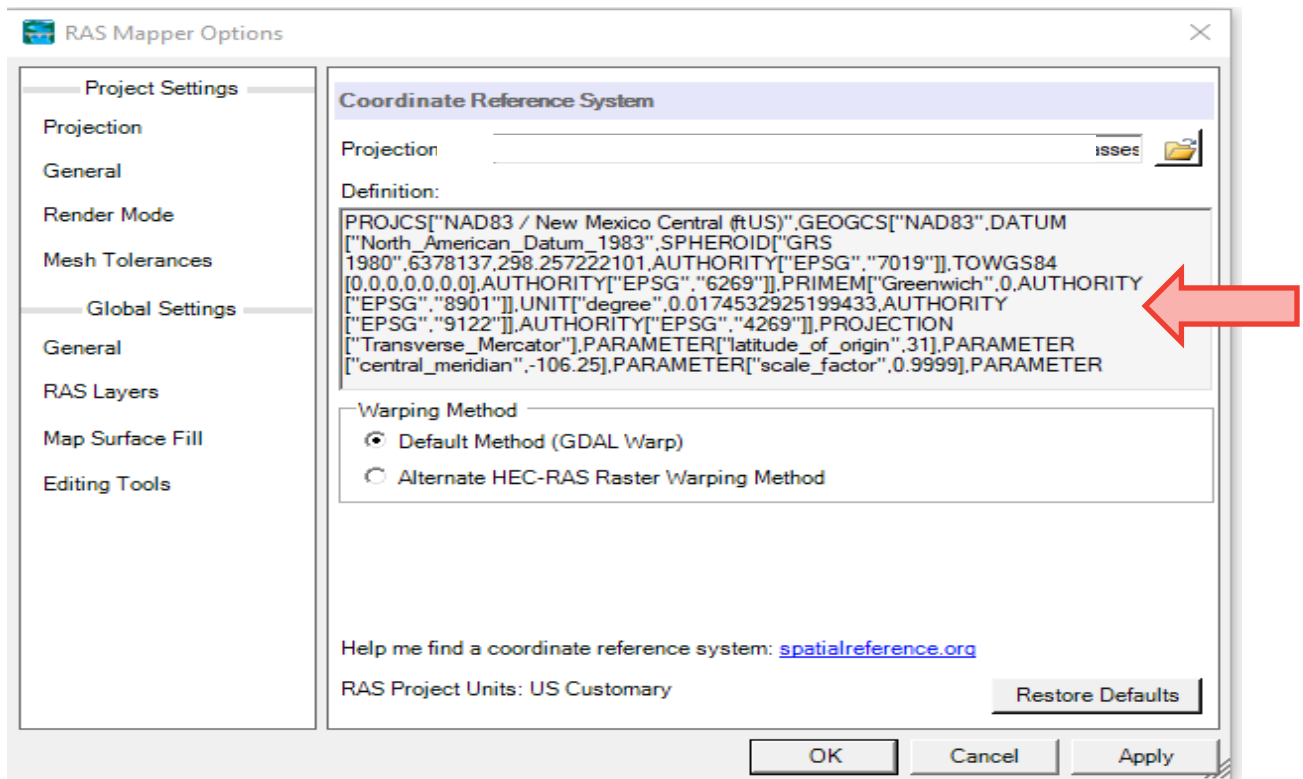

Figure 6- 12: Project Projection Details

Terrain files, polylines and other shapes that are correctly georeferenced can now be used for the model. RAS Mapper can also be used to load real time aerial imagery as shown below.

5. Right click Map Layers > Add Web Imagery Layer
6. Choose the layer that is most appropriate.

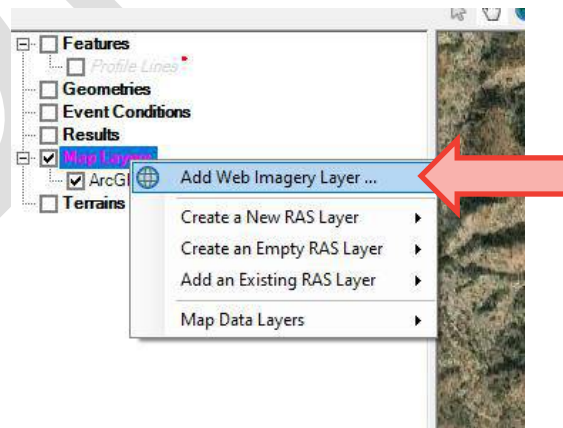

Figure 6- 13: Web Imagery Layers



*Figure 6- 14: RAS Terrain Data*



*Figure 6- 15: RAS Aerial Imagery*

## **6.5 GENERAL GUIDELINES**

Sections 6.1-6.3 above provides background information on general HEC-RAS user information. Section 6.4 is common among all users when setting a model up. Ensuring that the project is set up correctly will provide a good foundation to build a project on. Unlike other HEC products where all models require the same input parameters, HEC-RAS is very specific to the area that you are studying. The area can vary greatly from terrain to structures to input parameters to cross sectional geometry. Sections 6.5-6.8 is designed to guide the user to think wholistically about what is needed, not necessarily a how-to guide on how to build a model. For more detailed information on how to draw cross sections, how to turn on labels, how to export data, etc. Please refer to the HEC-RAS User Manual and the HEC-RAS Technical Reference Guide. In general, the users will delineate a stream reach, add cross sections, adjust cross sectional geometry, apply the type of flow data, apply boundary conditions, apply a flow regime within the plan, run the model and check post run results.

### **6.5.1 Delineation of Stream Reach and Cross Sections**

#### **6.5.1.1 Guidelines for Delineating Stream Reach**

For channels where the geometry is uniform without much braiding and meandering, the stream centerline may be drawn along the true centerline of the channel. For natural arroyos that are braided and meandering the engineer must determine the thalweg of the channel and draw the centerline to follow the thalweg. The river reach should be drawn such that the cross-section stations must decrease from the most upstream cross section to the most downstream section. The example below shows the upstream most cross section having a river station of 2033 while the downstream most cross section has river station of 57.



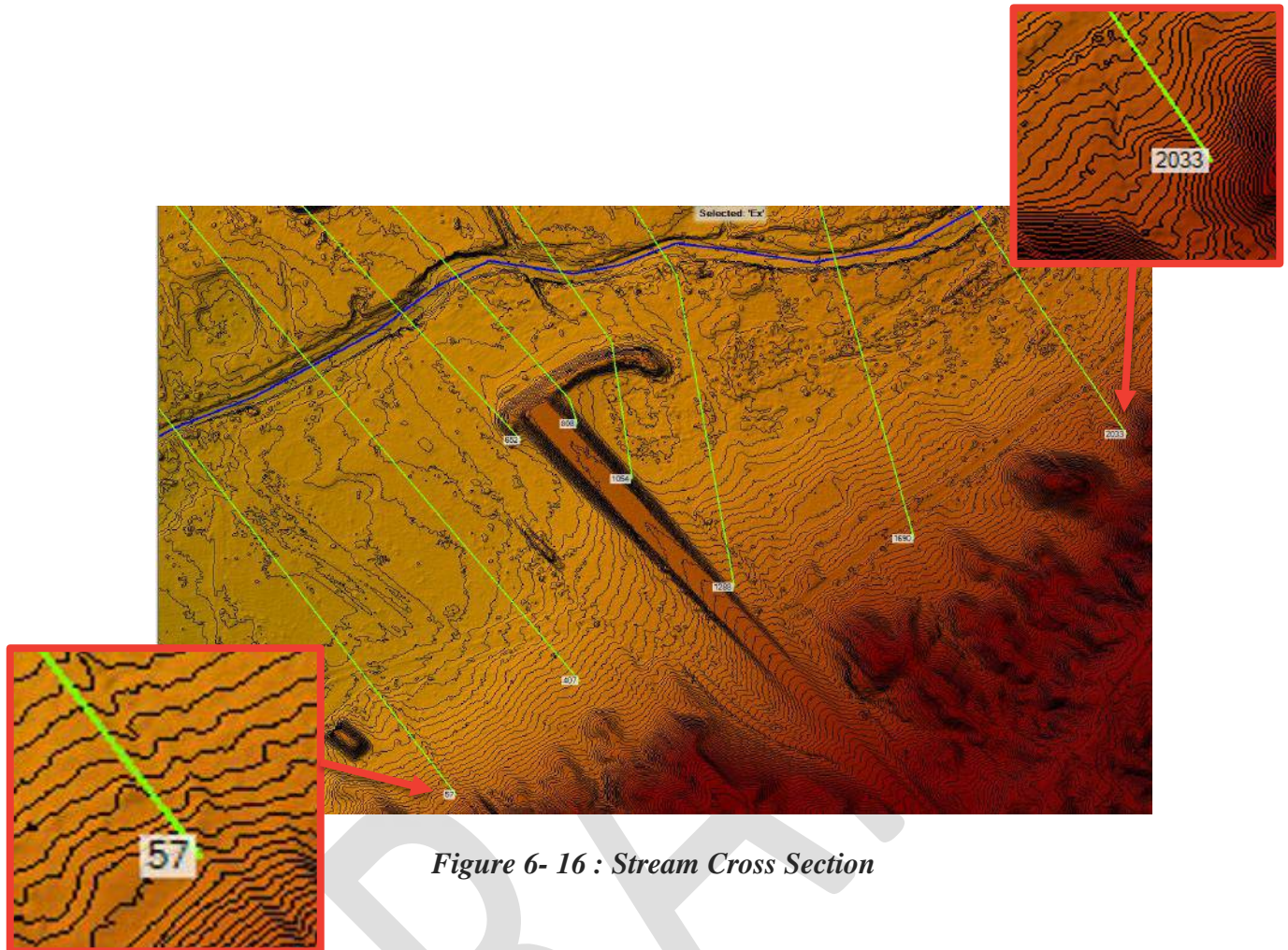

*Figure 6- 16 : Stream Cross Section*

The geometry model can now be used to delineate the stream reach and cross section data. A profile should be plotted prior to moving forward to ensure that the upstream to downstream direction is correctly oriented. The profile should indicate that the stream reach begins at the furthest downstream point, with distance increasing towards the furthest point upstream. This will ensure that the river stations increase in the upstream direction, as noted previously.

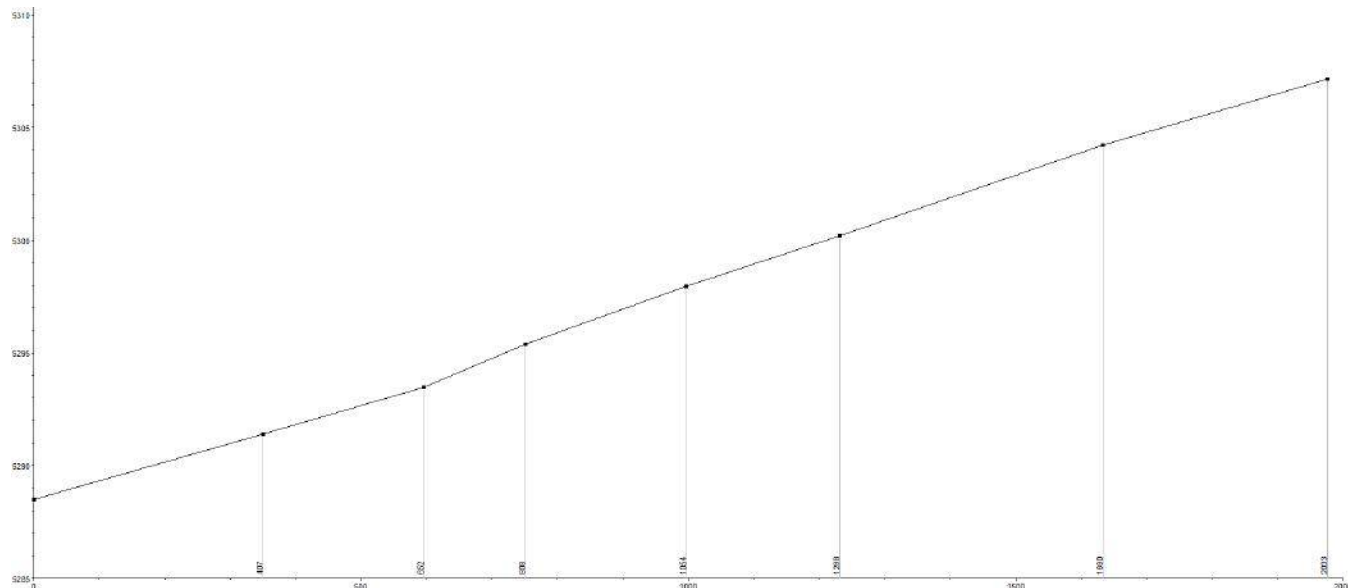

*Figure 6- 17: Profile of Stream Reach Data*

### 6.5.2 Guidelines for Locating and Delineating Channel Cross Sections

Delineating cross sections is a crucial step for the model to effectively compute the hydraulic parameters for the arroyo or channel being analyzed. The model will interpolate between the cross sections to calculate all hydraulic parameters. The cross sections need to accurately capture the hydraulic characteristics of the typical channel geometry, with more cross sections placed in areas of interest or areas with changes to channel geometry to nearby terrain. Channels with high geometric variability or numerous structures will require more cross sections to include these areas of interest in the calculations. Cross sections should be drawn from right to left looking downstream, to ensure that they are displayed appropriately in the Cross Section Editor. The stretch of cross section between bank stations should cross the stream reach perpendicularly but can bend freely to encompass surrounding terrain outside of the bank station limits. Each cross section should terminate on a high point. It is a general rule to keep cross sections similar in length. Cross sections can vary in length; however length should change gradually from one to the next to avoid errors in interpolation. Any structures placed between cross sections will be similarly interpolated for length as well as hydraulic characteristics, so this should be kept in mind when editing nearby cross sections.

### 6.5.3 Example of Cross-Sectional Data

In the arroyo shown below, the channel geometry varies. The upstream section of the channel shown in yellow flows into a contracted section, followed by the blue section. The blue section meanders into an expanded section that transitions into an expanded braided section. It terminates into the braided and contracted section shown in green. For a system as shown below, enough cross sections must be cut to capture the various transitions. The subsequent figure shows the various cross sections that were cut appropriately.

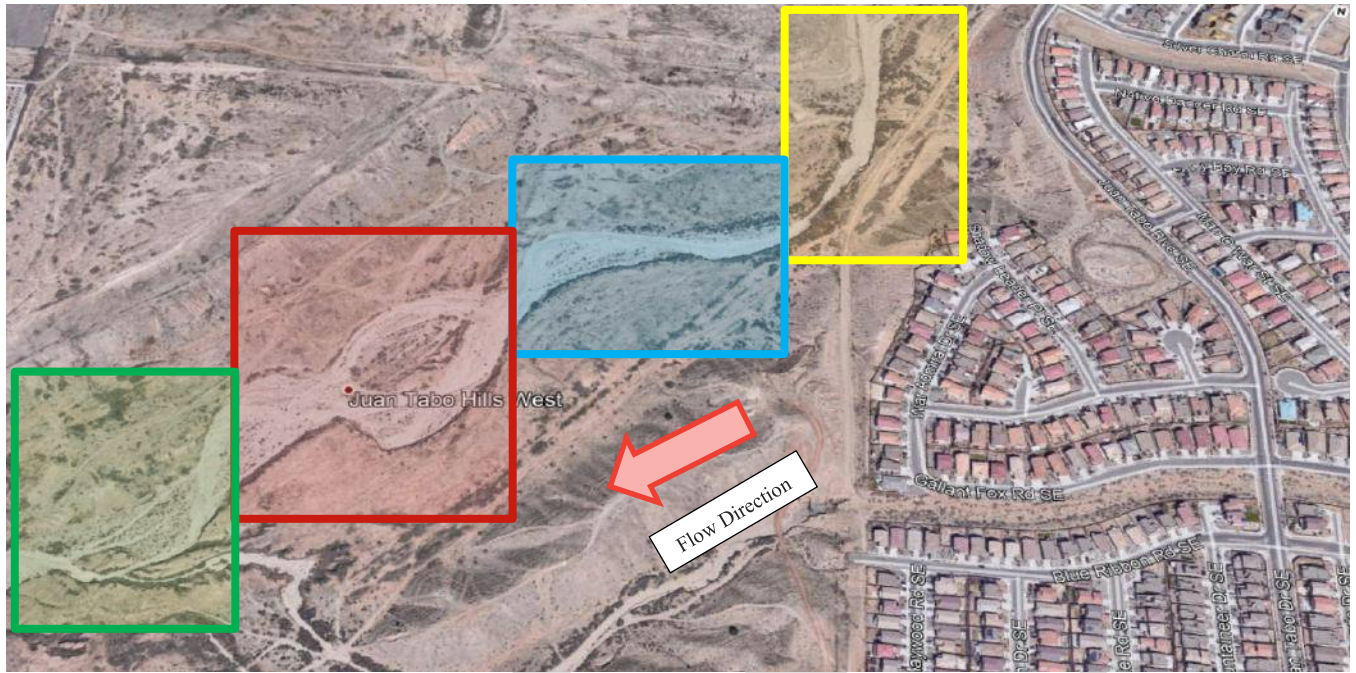

**Figure 6- 18: Natural Arroyo Changing Flow Path Geometry**

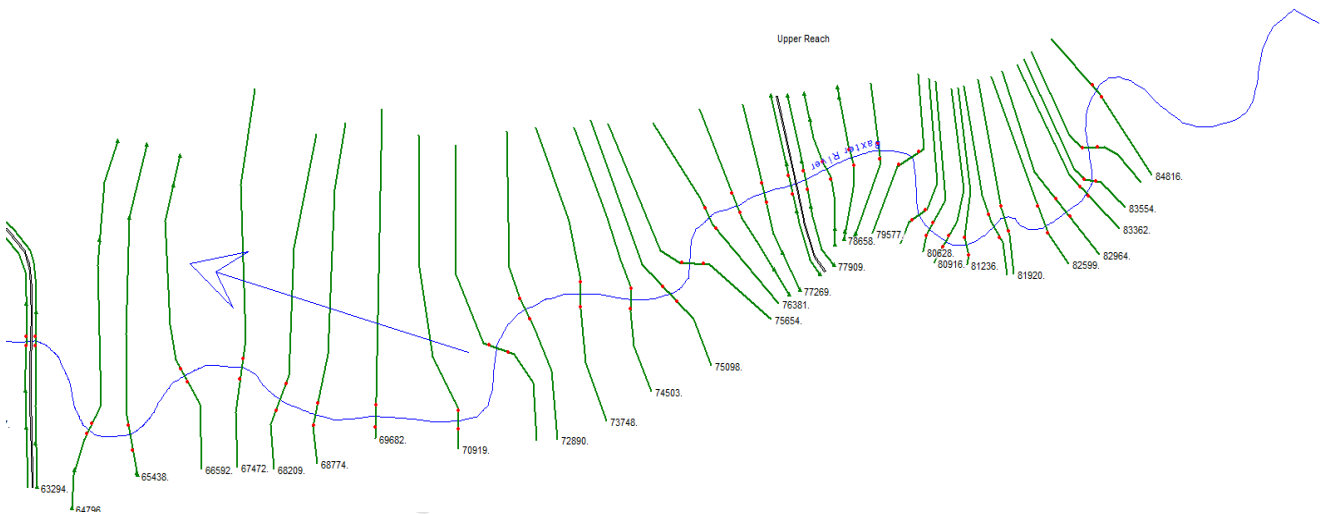

**Figure 6- 19: Natural Arroyo Corresponding Cross Sections**



### 6.5.4 Cross Section Geometry

The terrain data incorporated in the various cross sections should capture the effective width of the main channel and overbank areas. If not, adjustments may need to be incorporated to account for the entirety of the terrain at that cross section, they should always terminate at high points in the terrain. The main channel geometry must be determined, and bank stations assigned, so that the model can compute flows in the main channel and overbank areas for the arroyo being analyzed. If the model is georeferenced, RAS Mapper can be used to compute the downstream lengths for the main channel as well as left and right overbanks. The Mannings coefficient should be assigned and varied appropriately based on site observations. Documentation for Mannings coefficients must be provided by the engineer. A reference guide is provided in Table 3-1 of the HEC-RAS user manual. Expansion and contraction losses for most channels are by default. Recommendations for expansion and contraction values are provided in Table 3-3 of the HEC-RAS user manual. A typical cross section plot is shown below. The bank stations assigned to the cross section are shown by the red dots in the cross-section plot.

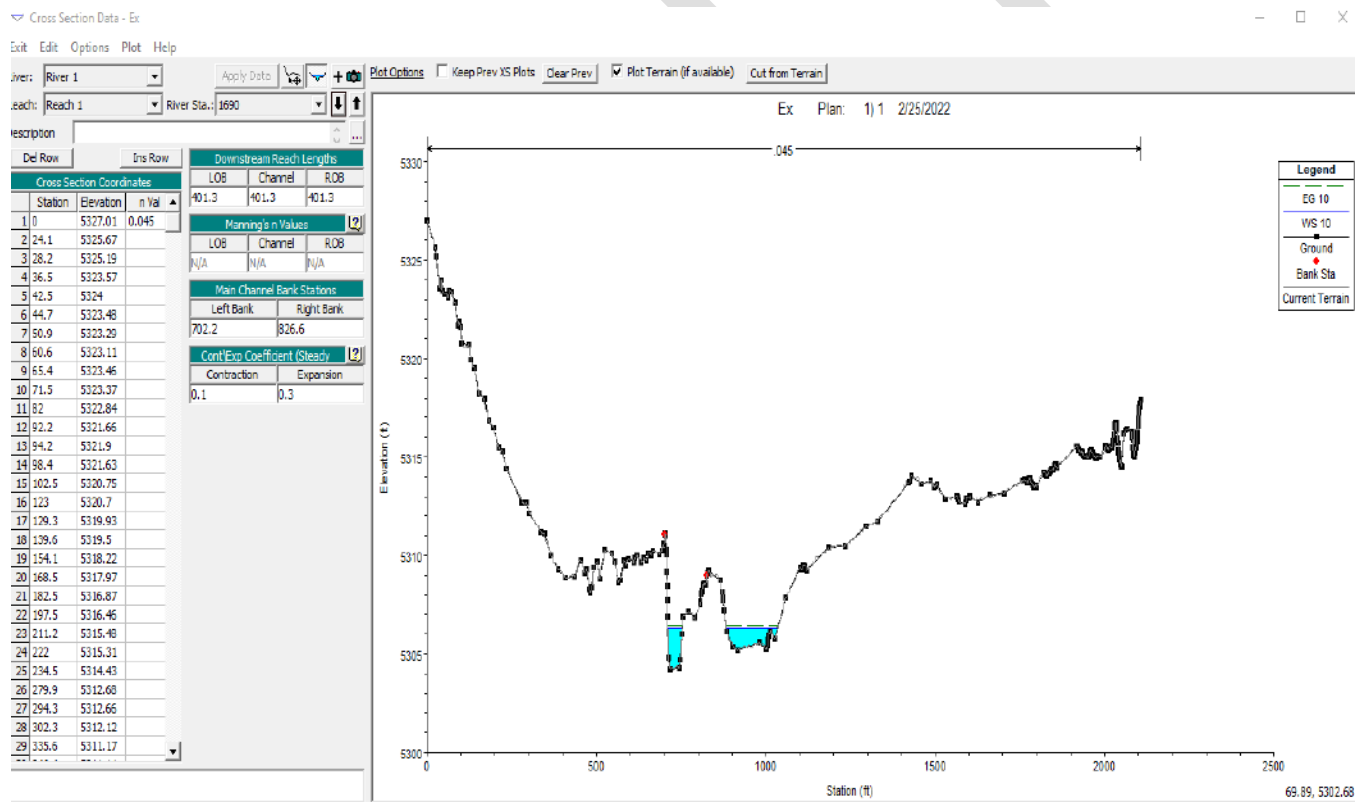

Figure 6- 20: Cross Section Editor

## 6.6 STRUCTURES

Bridges and culverts are some of the special structures that can be incorporated into the open channel modeling. More than one structure can be included in any model and all structures can be modified to represent the most accurate conditions. Field work should be done prior to modeling any structures to ensure that the as-built documents still accurately represent the condition and existence of the structures. Measurements taken in the field should be guided by the parameters deemed necessary by the model, outlined in the sections below.

### 6.6.1 Incorporating Bridges

The details of the bridge and culvert data will be site specific. For bridges, all pertinent bridge geometric input data should be based on as-built data or survey data. General guidelines for modeling bridges will be provided here. HEC-RAS requires four critical cross sections as shown in Figure 6-21 below, which comes from the HEC-RAS User Manual Figure 5.5.11. The purpose of these cross sections is to capture the uncontracted upstream section (Cross section 4), a representative cross section just upstream of the bridge (Cross section 3), a representative section just downstream of the bridge (Cross section 2), and a cross section sufficiently downstream that captures the rapid expansion of the channel (Cross section 1).

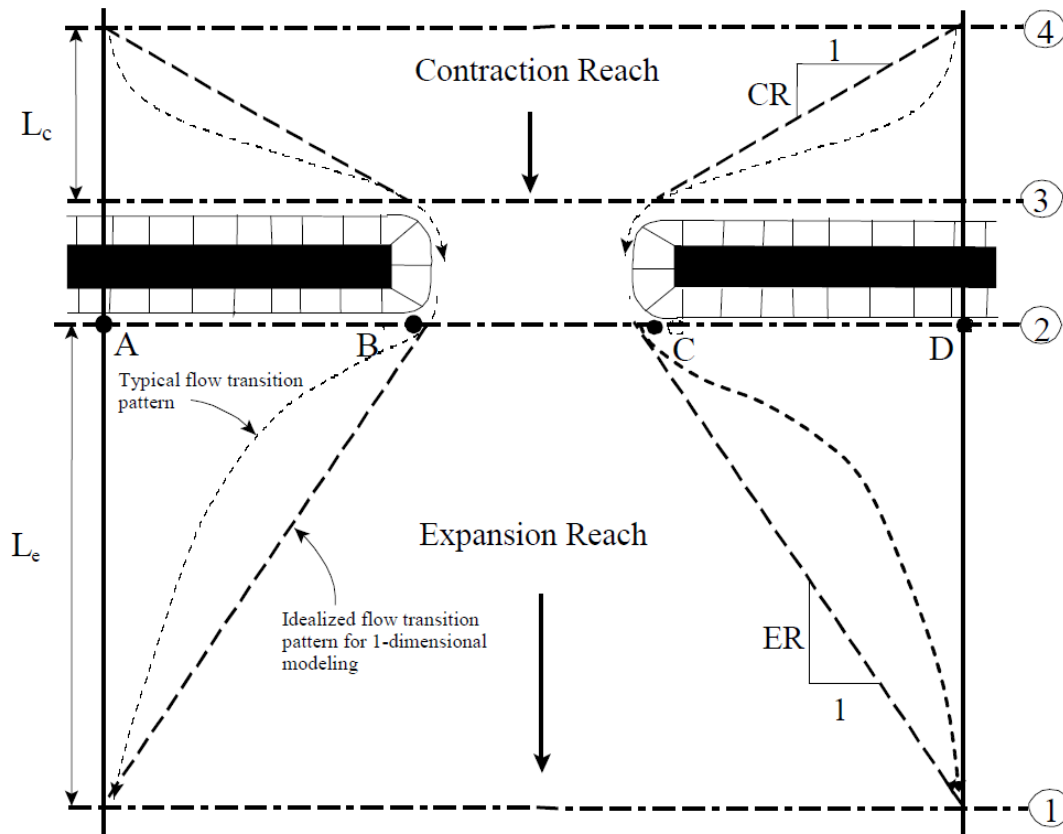

Figure 6- 21: Bridge Cross Section Plan View

### 6.6.2 Bridge Editor

For these contractions, the expansion and contraction coefficients should be picked based on guidance provided in Table 3-3 of the HEC-RAS User Manual. The bridge/culvert editor is located in the left pane of the geometry editor.

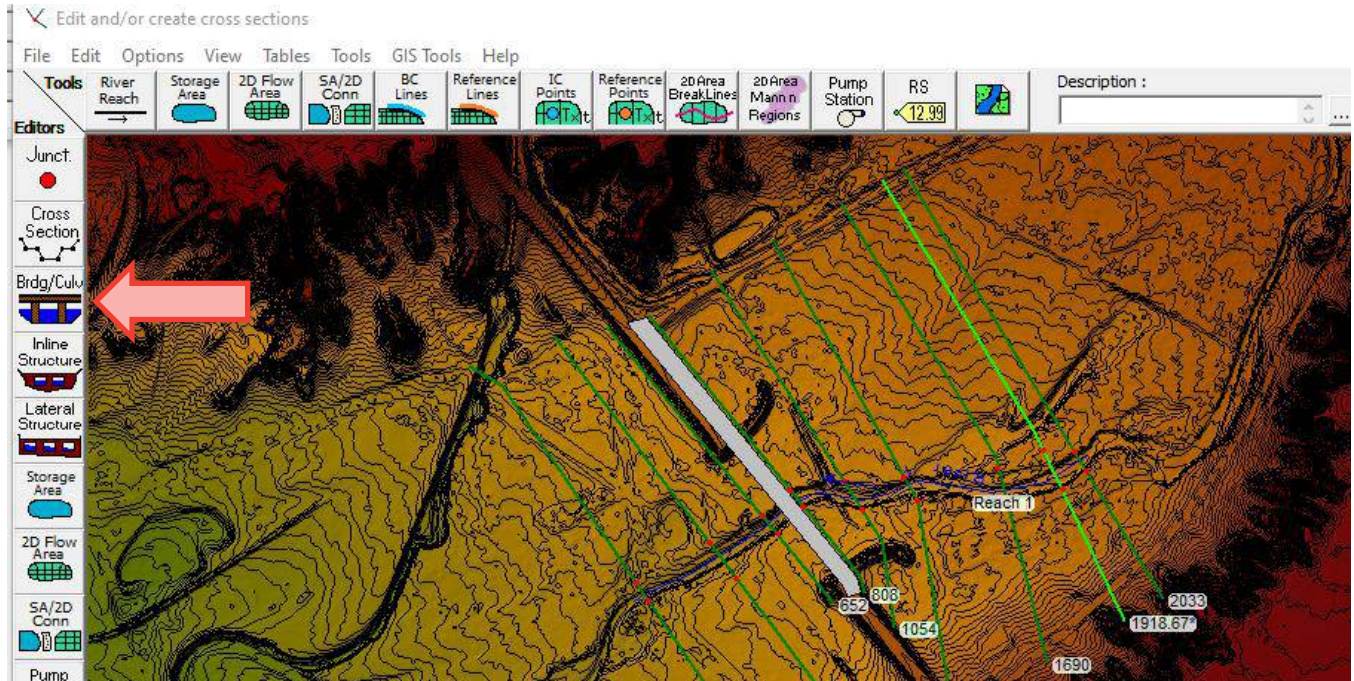
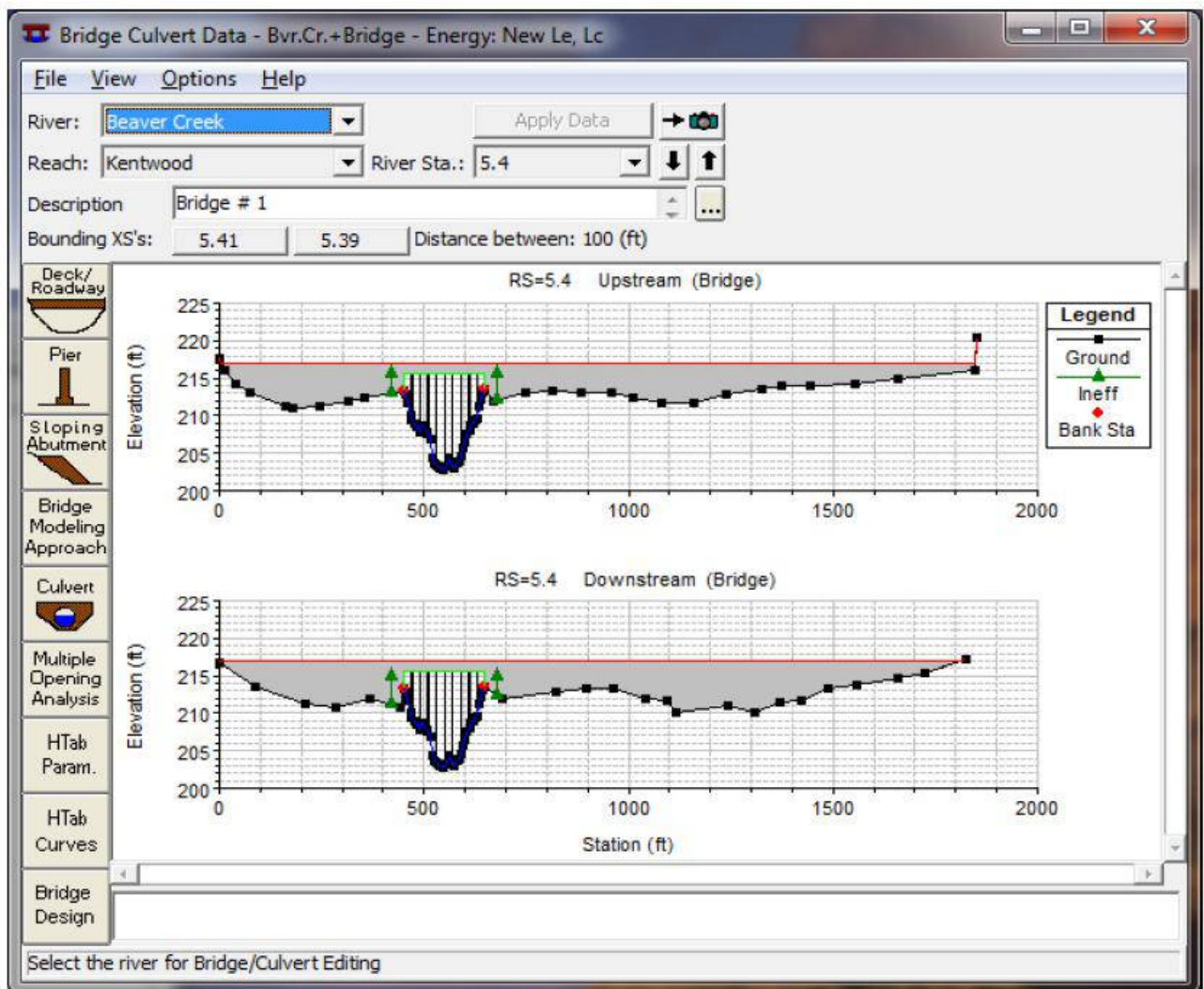

Figure 6- 22: Bridge Editor Button in Geometry Editor



*Figure 6- 23: Bridge Editor*

The following parameters can be defined for a bridge structure:

- River
- Reach
- River station
- Bridge deck and roadway station elevation data

To define the length of the bridge/culvert in the direction of the roadway, the depth or thickness of the bridge girder also must be defined. For bridges that overtop, a minimum weir flow elevation must be defined. This should be the lowest point on the bridge deck. The default assumption is that the bridge deck will function as a broad crested weir.



Upstream			Downstream			
	Station	high chord	low chord	Station	high chord	low chord
1	0.	216.93	200.	0.	216.93	200.
2	450.	216.93	200.	450.	216.93	200.
3	450.	216.93	215.7	450.	216.93	215.7
4	647.	216.93	215.7	647.	216.93	215.7
5	647.	216.93	200.	647.	216.93	200.
6	2000.	216.93	200.	2000.	216.93	200.
7						
8						

Figure 6- 24: Bridge Deck and Roadway Editor

- The distance field is used to enter the distance between the upstream side of the bridge deck and the cross section immediately upstream of the bridge.
- The width represents the width of the roadway in the direction of flow.
- **Weir coefficient should be kept at 2.6.** The model will reduce the weir coefficient to appropriately address any changes to the tailwater elevation.
- Pier data station elevation data is used to represent the centerline station of each bridge pier. Data required for width should be based on as-built data or survey data.

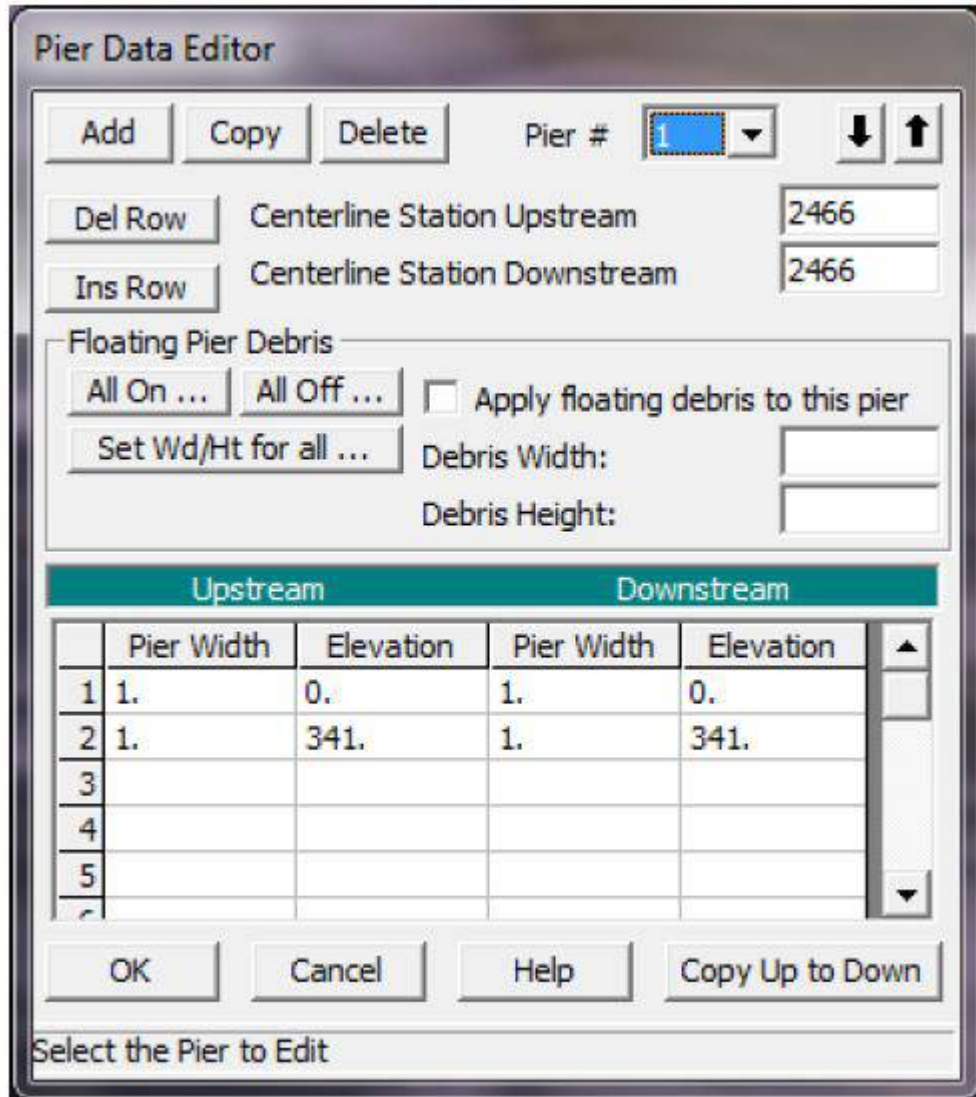

*Figure 6- 25: Pier Data Editor*

Sloping abutment station elevation data is typically used for abutments that protrude into the conveyance area of the channel as shown. Station elevation data should be based on as-built data or survey data.

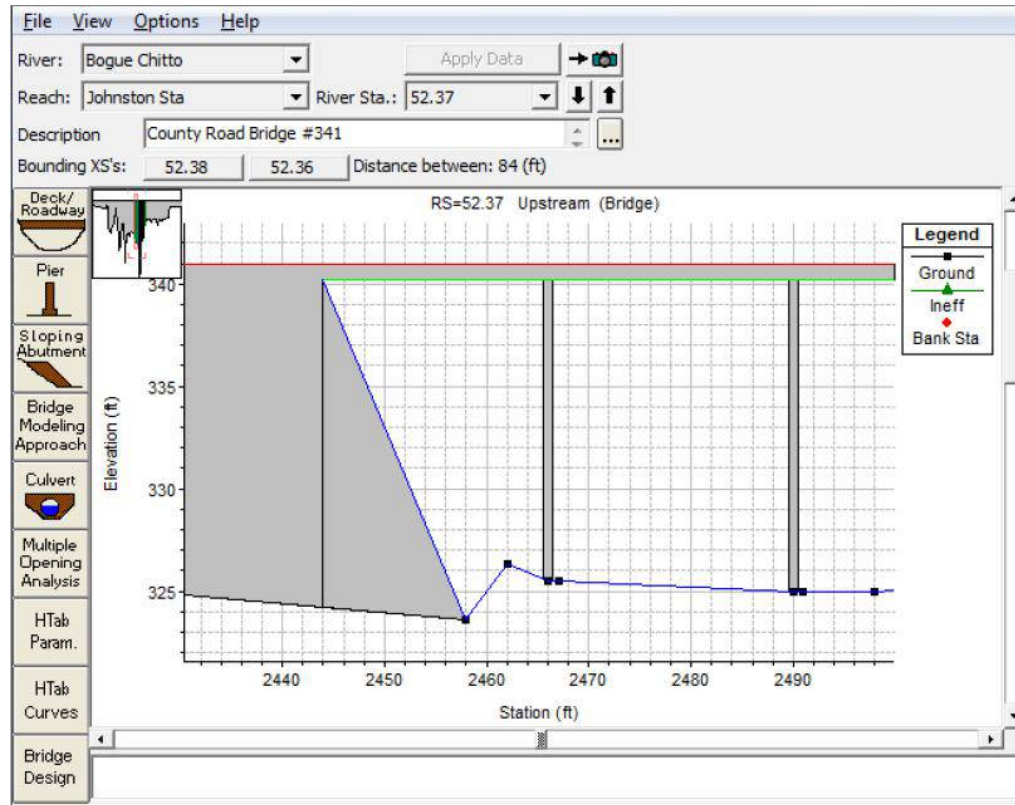

Figure 6- 26: Pier Data

### 6.6.3 Culvert Data Editor

Culverts can be simulated in HEC-RAS using the Bridge/Culvert data editor as well. The general parameters such as the river name, reach name, bounding cross sections, roadway and deck information is the same. However, the specific culvert data required is shown below. Culvert input data should be based on as-built data or survey data.

**Culvert Data Editor**

Culvert Group:

Solution Criteria:

Shape:  Span:  Rise:

Chart #:

Scale #:

Distance to Upstrm XS:

Culvert Length:

Entrance Loss Coeff:

Exit Loss Coeff:

Manning's n for Top:

Manning's n for Bottom:

Depth to use Bottom n:

Depth Blocked:

Upstream Invert Elev:

Downstream Invert Elev:

**Culvert Barrel Data**

Barrel Centerline Stations # Barrels :

	Barrel Name	US Sta	DS Sta
1	Barrel #1	988.5	988.5
2	Barrel #2	1011.5	1011.5
3			
4			
5			

Barrel GIS Data: Barrel #1  
Length: 0

	X	Y
1		
2		
3		
4		
5		

Select culvert to edit

Figure 6- 27: Culvert Data Editor

## 6.7 VIEWING RESULTS

Results are found in the main menu and in the RAS Mapper application. Profile plots for all stream reaches with or without culverts, and cross section with structures should be provided in the main menu. Additionally, tabular results can be found in the main menu in HEC-RAS. Modification to output tables can be done through the Options menu in the Profile Output Table window. RAS Mapper will populate



the Results section of the left-hand contents after successful runs. Users should specify which results layers to include in the mapping interface. Various properties can be modified to display results in RAS Mapper as well.

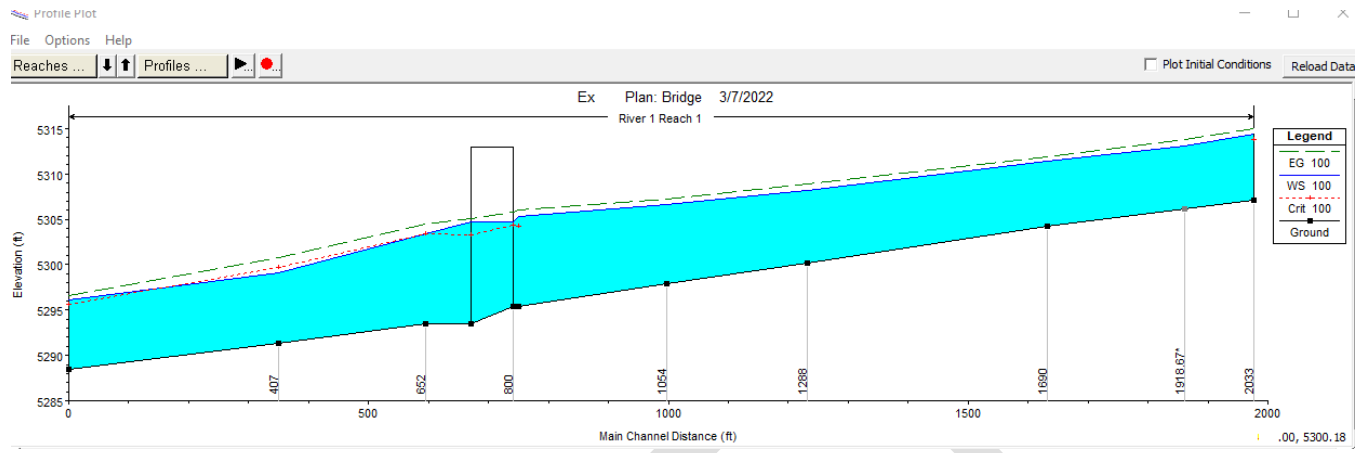

Figure 6- 28: Profile Plot of Stream Reach

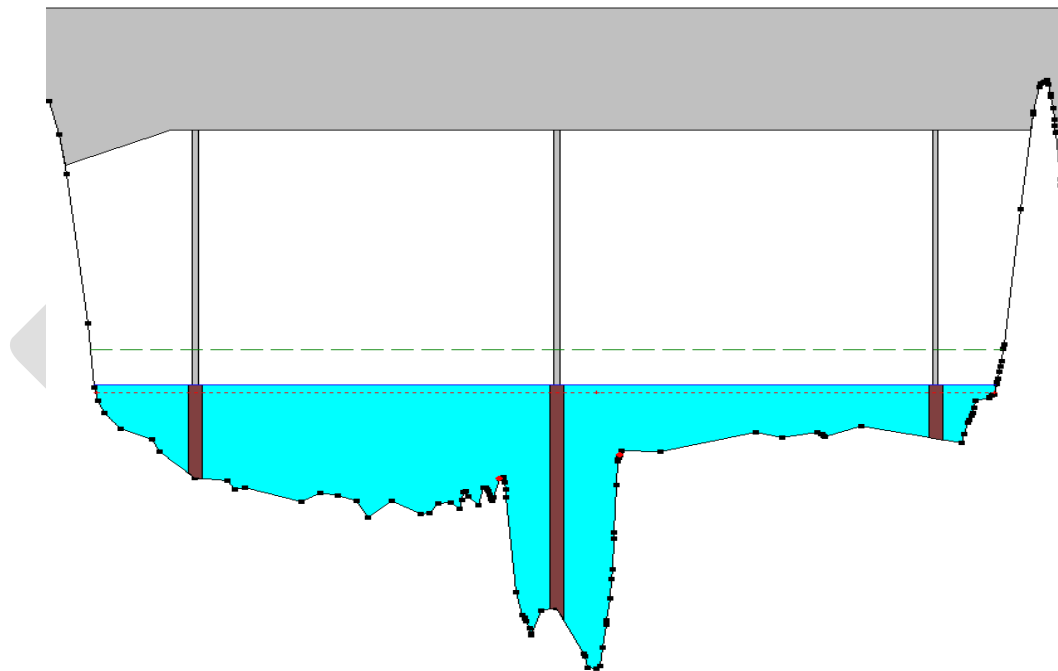

Figure 6- 29: Profile Plot of Cross Section

### 6.7.1 Channel Profile

A channel profile should be plotted to ensure there are no anomalies in the water surface profile. An example is shown below. Anomalies may include flow moving beneath the channel bottom, unexpected hydraulic jumps, blocked culverts displaying unrestricted flow, etc.

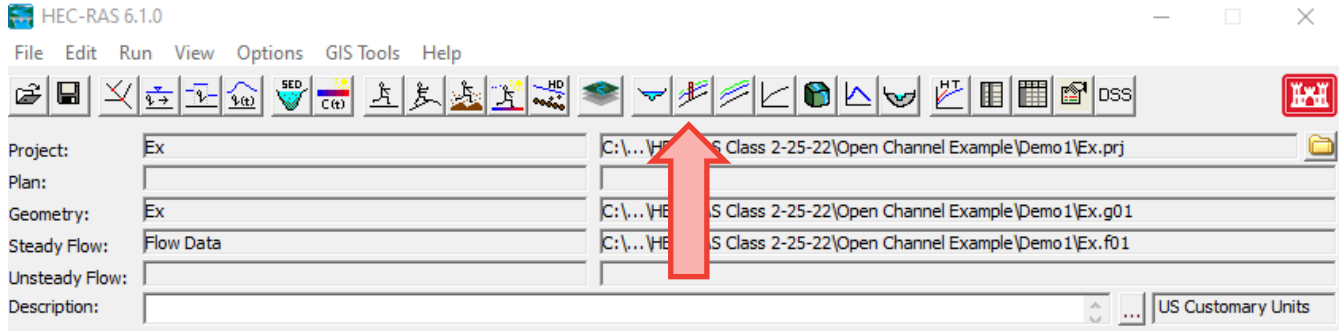

Figure 6- 30: Channel Profile in Toolbar

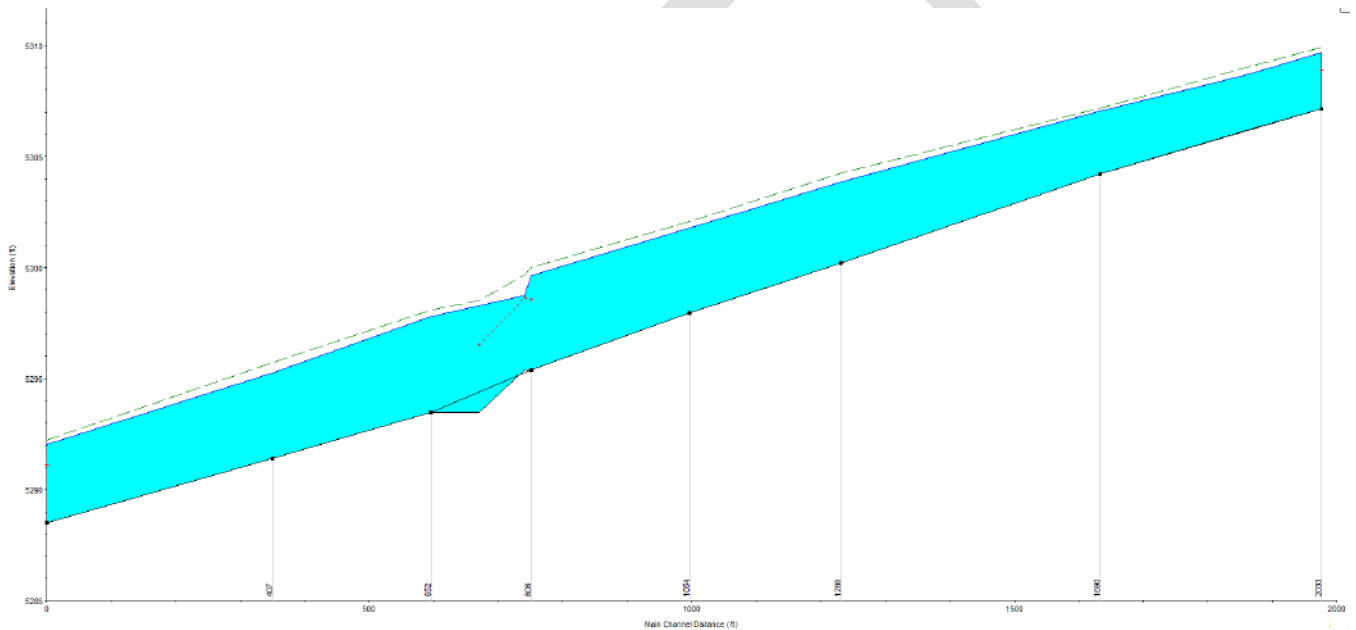
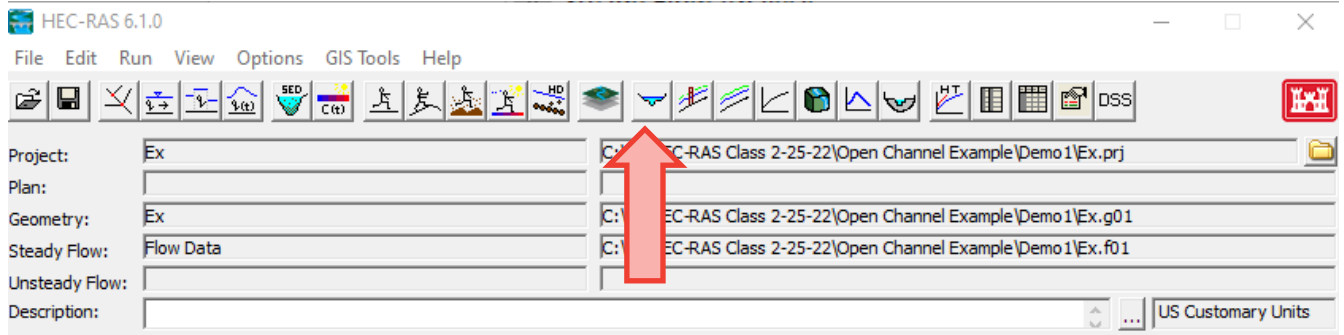

Figure 6- 31: Plotted Channel Profile

## 6.7.2 Water Surface

The water surface in any cross section can be viewed using the cross-section viewer. A typical cross section plot is shown below. If the cross-section limits do not capture the full extent of the inundation limits, the model will demonstrate the error in the cross-section viewer as well as the RAS Mapper.



*Figure 6- 32: Cross Section Viewer in Toolbar*

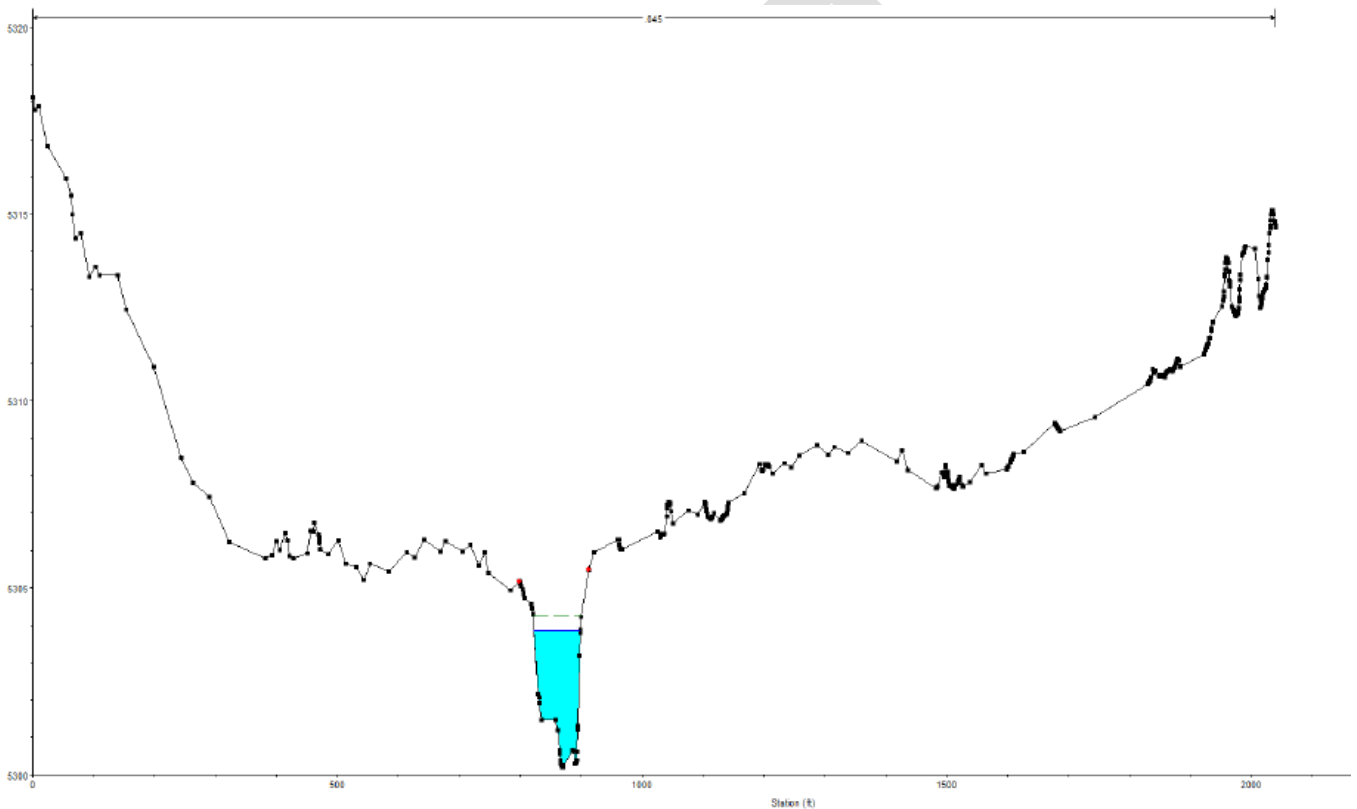

*Figure 6- 33: Plotted Cross-Section Profile*

Results can be viewed using the Output Icon in the toolbar which provides a detailed output for the bridge or culvert structure.

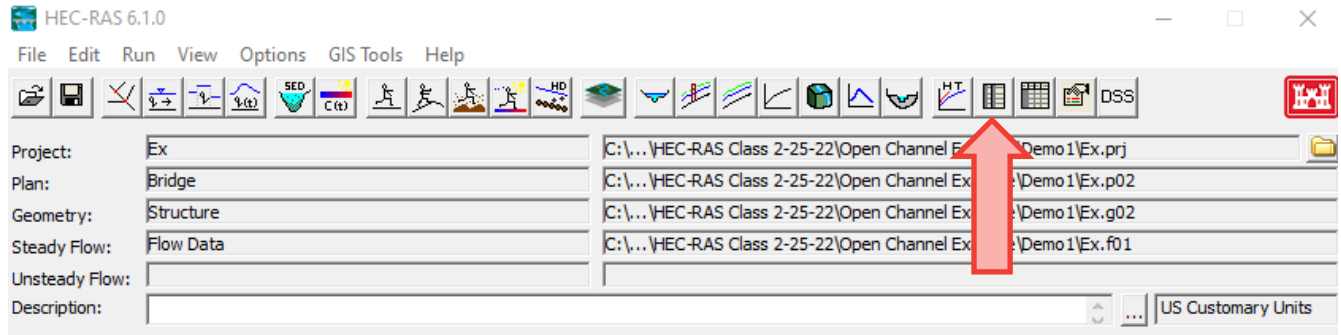

Figure 6- 34: Detailed Output Icon

Plan: 1 River 1 Reach 1 RS: 800 Profile: 100				
E.G. US. (ft)	5306.02	Element	Inside BR US	Inside BR DS
W.S. US. (ft)	5305.37	E.G. Elev (ft)	5305.81	5305.05
Q Total (cfs)	15000.00	W.S. Elev (ft)	5304.67	5304.74
Q Bridge (cfs)	15000.00	Crit W.S. (ft)	5304.41	5303.34
Q Weir (cfs)		Max Chl Dpth (ft)	9.27	11.26
Weir Sta Lft (ft)		Vel Total (ft/s)	7.94	4.10
Weir Sta Rgt (ft)		Flow Area (sq ft)	1888.69	3659.26
Weir Submerg		Froude # Chl	0.51	0.23
Weir Max Depth (ft)		Specif Force (cu ft)	7995.79	10126.56
Min El Weir Flow (ft)	5317.00	Hydr Depth (ft)	3.05	2.77
Min El Prs (ft)	5313.00	W.P. Total (ft)	690.45	1354.99
Delta EG (ft)	1.55	Conv. Total (cfs)	144759.2	283255.1
Delta WS (ft)	1.95	Top Width (ft)	619.15	1319.38
BR Open Area (sq ft)	8204.35	Frctn Loss (ft)	0.34	0.35
BR Open Vel (ft/s)	7.94	C & E Loss (ft)	0.42	0.22
BR Sluice Coef		Shear Total (lb/sq ft)	1.83	0.47
BR Sel Method	Energy only	Power Total (lb/ft s)	14.56	1.94

Figure 6- 35: Bridge Output

As part of any HEC-RAS analysis, all input and output data should be provided along with all documentation for assumptions, as-builts, and survey.

## 6.8 POST RUN RESULTS

After a successful run, it is imperative that the engineer verify all profiles, cross section plots and inundation limits. If the inundation limits exceed the cross-section limits, then some flow will not be accounted for in the model. Affected cross sections should be redrawn to extend past the expected inundation limits to model the full extent of flow. The example below demonstrates cross sections that capture the full extent of the inundation limits. Results for depth, velocity and various other parameters are populated in RAS Mapper based on the Plan ID. An example of the depth grid is shown below.



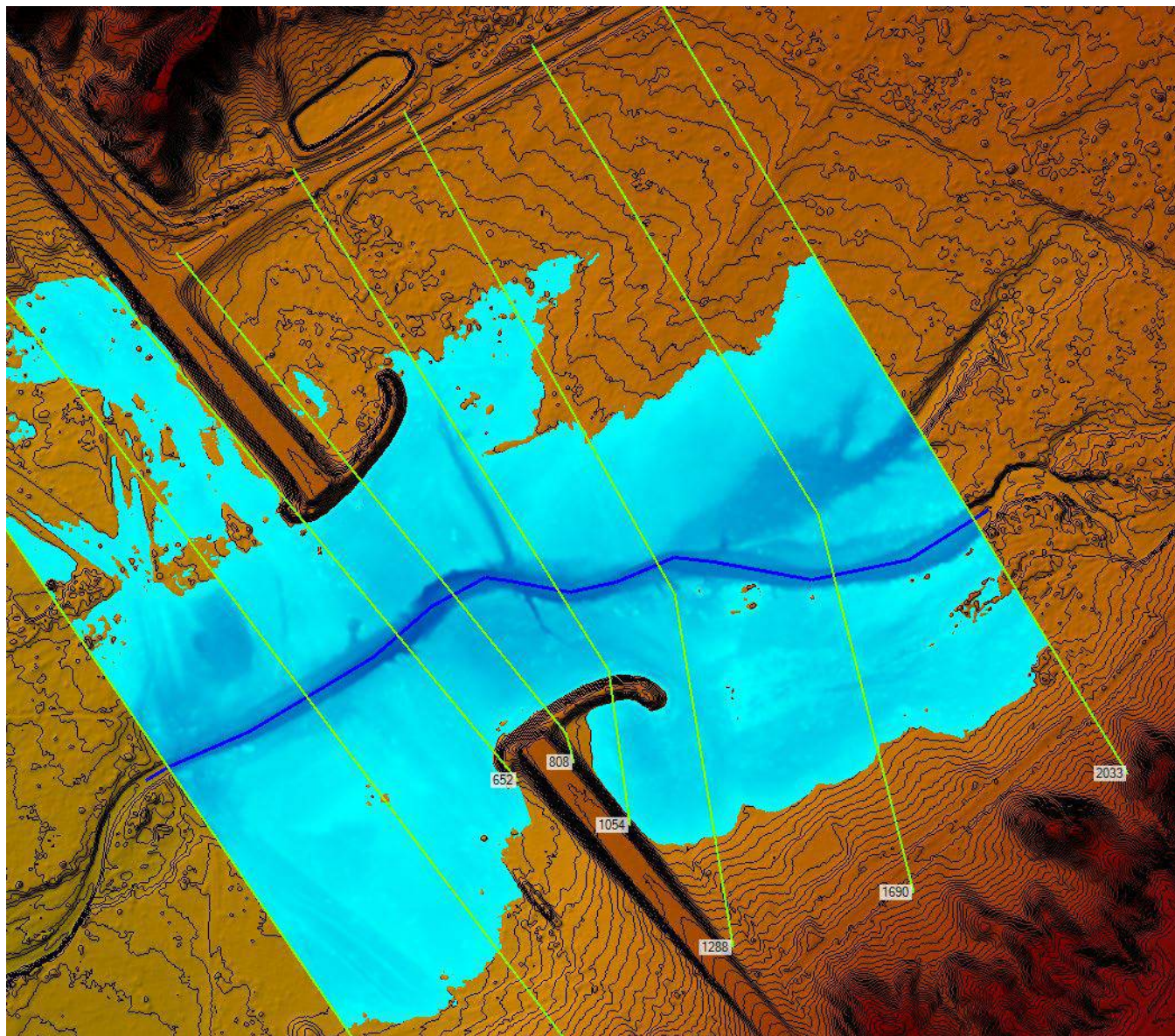

**Figure 6- 36: RAS Mapper Results Post Run**

All results should be carefully examined to ensure the model is an accurate predictor of flow regime and profiles for the reach in question. It is the responsibility of the engineer to ensure that in situ conditions are represented correctly within the model, and the hydraulics of the reach have been calculated by the model appropriately. Results can be exported to formats compatible with other programs such as ArcGIS Pro or Civil3D. For more information, please refer to the HEC-RAS User Manual.